



# University Design and Construction Standards

September 2024 Release

# CONTENT

## Table of Contents

<b>Content.....</b>	<b>2</b>
Table of Contents.....	2
<b>Preamble .....</b>	<b>16</b>
Design Guiding Principles.....	16
Health, Safety, and Welfare .....	16
Utility Infrastructure .....	16
Efficient and Effective Use of Resources and Materials .....	17
University’s Mission and Strategic Goals .....	17
Aesthetic Cohesiveness and Inclusiveness .....	17
Key Master Plan Elements .....	18
Planning Framework .....	18
View Corridors .....	18
Building Setbacks .....	18
Building orientation .....	18
Building Form & Massing .....	19
Building Heights .....	19
Building Facades and Fenestrations.....	19
Existing Traditional Buildings .....	19
New Buildings.....	19
Architectural Design.....	20
Appropriate Materials.....	20
Brick .....	20
Stone .....	20
Metal.....	21
Glass .....	21
Architectural Elements to Include/Avoid.....	21
Rustication .....	21
Quoins .....	21
Colonnades and Porticos .....	22
Arched Entry .....	22
Glass Entry.....	22

Window Fenestration ..... 22

Cornices and Roof Edges ..... 23

Sloped Roofs ..... 23

Landscape Architectural Design ..... 23

    Structure/Space Definition ..... 24

    Scale ..... 24

    Plant Character ..... 24

    Plant Patterns ..... 25

    Specific Area Character/Guidelines (including edges) ..... 26

        Library Mall & Extension South ..... 26

        Campus Grove ..... 26

        Campus Edges, Perimeter Streets, and Other Characteristics ..... 28

Half-Percent for Art ..... 29

Exceptions and Modifications ..... 29

**Planning ..... 31**

    General ..... 31

        Designer's Relationship to the University ..... 31

        Building Address ..... 31

        Initial Planning Conference ..... 31

        Project Development Schedule ..... 31

        Review of Design ..... 32

            Presentations and Review Conferences ..... 32

            Schematic Design Conferences ..... 32

            End-of-Phase Reviews ..... 32

            Conference Memoranda ..... 32

            Submittals for Outside Review ..... 33

            Submittals for University Review ..... 33

        Payments to Designer ..... 33

        Project Development Phases ..... 33

            Schematic Design Phase ..... 33

                Schematic Design Submittal ..... 34

            Design Development Phase ..... 34

                Design Development Submittal ..... 34

            Construction Documents Phase ..... 35

Final Construction Documents Submittal ..... 35

Bidding Phase..... 35

**Design..... 36**

Campus Design..... 36

    Design within Available Funds ..... 36

    Flexibility by Design..... 36

    Maintainability and Access ..... 37

    Standard Stock Items ..... 37

    Hazardous Materials ..... 37

    Radiation Sources ..... 37

    Special Scheduling and Construction Constraints..... 37

    Colors for Materials and Finishes..... 38

Site Design..... 38

    Ramps and Steps..... 38

    Building Entry..... 38

    Parking ..... 38

    Outdoor Spaces..... 38

    Site Drainage..... 39

    Existing Utilities..... 39

Interior Design ..... 39

    Corridors ..... 39

    Space Organization ..... 39

    Office Standards..... 39

    Interior Wall Construction ..... 40

Classrooms ..... 40

    Classrooms Systems Design ..... 40

    Classroom Lighting Control ..... 41

Custodial Closets..... 41

Mail Service Facilities ..... 42

Mechanical and Electrical Equipment Rooms..... 42

Public Restrooms Facilities..... 43

Recycling Alcoves ..... 43

**Construction ..... 44**

    00 Procurement and Contracting Requirements..... 44

01 General Requirements ..... 44

    01 14 00 Work Restrictions ..... 44

        Site Limits ..... 44

        Use of Owner's Drinking and Toilet Facilities ..... 44

        Contractor's Working Hours ..... 44

        Noise-Making Activities ..... 44

    01 14 13 Access to Site..... 45

    01 14 16 Coordination with Occupants ..... 45

    01 14 33 Work in Rights-of-Way ..... 45

    01 31 19.13 Preconstruction Meetings..... 45

    01 32 29 Periodic Work Observation ..... 45

    01 33 00 Submittal Procedures..... 45

    01 35 23 Owner Safety Requirements ..... 45

    01 35 46 IAQ Procedures ..... 46

    01 35 53 Security Procedures ..... 46

    01 41 13 Codes..... 46

    01 41 16 Laws..... 47

        Accessibility..... 47

        Energy Conservation ..... 47

        Excavation ..... 48

    01 41 26 Permits ..... 48

    01 43 36 Field Samples..... 48

        Selection of Brick or Cast Panel for Exterior Walls ..... 48

    01 45 23 Testing and Inspecting ..... 48

    01 55 00 Vehicular Access and Parking..... 49

    01 56 00 Temporary Barriers and Enclosures ..... 49

    01 56 39 Temporary Tree and Plant Protection..... 49

    01 57 13 Temporary Erosion and Sediment Control..... 50

    01 58 00 Project Identification..... 51

    01 71 23 Field Engineering..... 51

    01 74 00 Cleaning and Waste Management..... 51

    01 77 00 Closeout Procedures ..... 52

    01 77 19 Closeout Requirements..... 52

    01 78 23 Operation and Maintenance Data ..... 52

01 78 29 Final Site Survey ..... 52

01 78 39 Project Record Documents ..... 52

01 78 46 Extra Stock Materials ..... 52

01 78 53 Sustainable Design Closeout Documentation ..... 55

01 79 00 Demonstration and Training ..... 55

01 81 13 Sustainable Design Requirements..... 56

    Materials Conservation ..... 56

02 Existing Conditions ..... 56

    02 01 00 Maintenance of Existing Conditions..... 56

        Protection of Campus Buildings, Streets and Sidewalks ..... 56

        Protection of Underground Utility Lines ..... 56

        Protection of Existing Trees ..... 57

    02 22 00 Existing Conditions Assessment ..... 57

    02 21 00 Surveys ..... 57

    02 41 00 Demolition..... 58

03 Concrete ..... 59

    03 30 00 Cast-in-Place Concrete ..... 59

    03 15 16 Concrete Construction Joints ..... 64

04 Masonry ..... 64

    04 21 13 Brick..... 64

05 Metals ..... 67

    05 05 23 Metal Welds ..... 67

    05 52 00 Metal Railings..... 67

06 Wood, Plastics, and Composites ..... 67

    06 22 00 Millwork ..... 67

07 Thermal and Moisture Protection ..... 68

    Roofing ..... 68

        General..... 68

        Standard Specifications..... 68

        Slope..... 68

        Design Parameters ..... 68

08 Openings ..... 70

    08 10 00 Doors and Frames ..... 70

    08 41 00 Entrances and Storefronts ..... 71

08 42 29 Automatic Entrances .....	71
08 50 00 Windows .....	71
08 71 00 Door Hardware.....	72
08 81 00 Bird Safety Glass.....	73
09 Finishes.....	73
09 50 00 Ceilings .....	73
Ceiling Tile .....	73
09 60 00 Flooring .....	74
09 72 00 Wall Coverings.....	75
09 91 13 Exterior Painting.....	75
09 91 23 Interior Painting .....	75
10 Specialties .....	76
10 14 00 Signage .....	76
Room Numbering.....	76
Interior Signage.....	77
Residence Hall Evacuation Signage.....	77
Building Signage .....	77
Building Plaque .....	78
Exterior Site Signage .....	78
10 41 16 Emergency Key Cabinets .....	78
10 43 13 Defibrillator Cabinets .....	78
10 73 43 Transportation Stop Shelters .....	78
11 Equipment.....	78
Rooftop Equipment.....	78
Fixed Equipment .....	79
Moveable Equipment.....	79
Equipment hangers and anchors .....	79
12 Furnishings .....	79
12 20 00 Window Treatments .....	79
12 30 00 Casework.....	79
Laboratories .....	79
12 50 00 Furniture .....	80
Selection and Procurement .....	80
Lighting.....	80

Layout Coordination ..... 80

Installation ..... 80

Modesty Panels on Modular Furniture ..... 80

14 Conveying Equipment ..... 80

14 20 00 Elevators ..... 80

    Elevator Pit Sub-drainage: ..... 81

    Elevator Controller ..... 81

    Elevator Equipment Rooms ..... 81

21 Fire Suppression ..... 82

    21 11 16 Fire Hydrants ..... 82

    21 13 00 Fire Sprinkler Systems ..... 82

22 Plumbing ..... 83

    Piping General ..... 84

    Piping Penetrations ..... 85

    Access Panels ..... 85

    22 05 25 Valves ..... 86

        Backflow Preventers ..... 86

        Table 22-01 ..... 87

    Isolation Valves and Unions ..... 87

    Domestic Hot Water ..... 87

    Drains ..... 88

    Safety Showers and Eyewash Stations ..... 88

    Water Pressure ..... 88

    22 40 00 Plumbing Fixtures ..... 88

        General ..... 88

        Fixture Mounting ..... 89

        Distilled Water ..... 89

        Water Coolers ..... 89

    Building Sewers ..... 89

        Changes of Direction ..... 89

        Base of Stack ..... 89

        Building Drain and Building Sewer Junction ..... 89

        Manholes ..... 90

23 Heating, Ventilating, and Air Conditioning (HVAC) ..... 91



23 08 00 Commissioning of HVAC..... 91

General Design ..... 91

Ventilation..... 91

Equipment Location and Access ..... 92

    Outdoor Equipment Location ..... 92

    Roofs ..... 92

    Mechanical Rooms..... 92

    Equipment Access ..... 93

Refrigerant ..... 93

Air Handling Systems ..... 94

    General..... 94

Air Handling Units ..... 94

Supply & Return Fans..... 95

    Exhaust Fans..... 95

Coils..... 95

Filters..... 95

Dampers..... 95

Ductwork..... 95

Diffusers ..... 96

Fume Hoods and Laboratory Systems ..... 96

    General..... 96

    Exhaust System ..... 97

    Fume Hoods ..... 97

    Ductwork..... 97

    Controls..... 97

Animal Quarters..... 98

Water Cooling Systems ..... 98

    Interior Chilled Water Systems ..... 98

        Piping..... 98

        Valves ..... 98

        Insulation ..... 98

    Chilled Water Distribution Loop ..... 99

    Chillers..... 99

    Cooling Towers..... 99

Building Heating System ..... 99

Central Utility Distribution System ..... 100

25 Integrated Automation ..... 101

    Energy Management and Control System (EMCS)..... 101

        EMCS Design Requirements..... 101

    Utilities Metering Equipment Guidelines..... 101

        Integration into Power Monitoring System ..... 101

        General..... 102

        Electricity Metering..... 102

        Chilled Water, Hot Water and Process Water Metering ..... 102

        Natural Gas Metering..... 103

        Domestic Water Metering ..... 103

26 Electrical..... 103

    26 05 15 – Wire and Cabling ..... 103

    26 27 05 – General Purpose Power and Lighting Circuits..... 103

    New Interior Construction Work Areas ..... 103

    Renovation Work Areas ..... 104

    Lighting Fixture Locations (both New Construction and Renovation Work Areas) ..... 104

        Recessed Lighting Fixture Locations ..... 104

        Emergency Lighting..... 105

    Surface or Exposed to Structure Lighting Fixture Locations ..... 105

    Busways..... 105

    Computer Room Power ..... 105

    Electrical Outlet Strips at Laboratories ..... 105

    Wireless Atomic Wall Clocks ..... 106

    Electrical Service Time Switch for exterior lighting ..... 106

    Receptacles ..... 106

    Electrical Boxes ..... 107

    Electrical Breaker Panel and Circuit Identification..... 107

    26 09 23 Lighting Control ..... 109

    26 10 00 Medium-Voltage Electrical Distribution..... 110

        Campus Primary Electric Distribution System ..... 110

        Distribution System..... 110

        Direct Burial Systems ..... 111

- Medium Voltage General ..... 111
- 26 12 00 Transformers ..... 112
  - Basic transformer installation ..... 113
- 26 13 00 Switchgear ..... 113
  - Cable Testing ..... 114
  - Medium Voltage Switches ..... 114
  - Fault indicators ..... 114
  - Execution..... 114
- 26 20 00 Low-Voltage Electrical Distribution ..... 114
  - Secondary Circuits General Requirements ..... 114
- 26 21 00 Low Voltage Service Entrance ..... 115
- 26 23 00 Low Voltage Switchgear ..... 115
- 26 24 00 Switchboards and Panelboards ..... 115
- Low Voltage Feeders ..... 115
- Branch Circuits ..... 115
- Conduit..... 116
- Devices and Motors ..... 116
- 26 32 00 Packaged Generator Assemblies..... 117
- 26 41 13 Lightning Protection for Structures..... 117
- 26 51 00 Interior Lighting..... 117
  - Lighting Fixture Types ..... 118
  - Lighting Level Guidelines ..... 118
  - Lighting of Large Interior and High-Bay Areas ..... 118
  - Lighting of Mechanical Equipment Rooms ..... 119
  - Maintenance Considerations ..... 119
- 26 56 00 Exterior Lighting ..... 119
  - Removal of Existing Fixtures ..... 121
  - Addition of New Free-Standing Fixtures ..... 121
  - Addition of New Wall Mounted Fixtures ..... 121
- 26 56 13 Lighting Poles and Standards ..... 122
- 27 Communications ..... 122
  - Telecommunications Ductbanks..... 122
- 28 Electronic Safety and Security..... 122
  - 28 10 00 Access Control ..... 122

28 46 00 Fire Detection and Alarm ..... 123

28 46 21 Fire Alarm ..... 123

32 Exterior Improvements ..... 124

32 12 16 Asphalt Paving ..... 124

32 16 23 Sidewalks ..... 124

32 17 23 Pavement Markings ..... 125

32 30 00 Site Improvements ..... 126

    Newspaper Racks and Machines ..... 126

32 31 00 Fences and Gates ..... 126

32 32 00 Retaining and Seating Walls ..... 126

32 33 13 Site Bicycle Racks ..... 127

32 33 23 Site Trash and Litter Receptacles ..... 127

    Outdoor Solid Waste Collection ..... 127

    Dumpsters ..... 127

32 33 43 Site Seating and Tables ..... 128

32 39 13 Metal Bollards ..... 128

32 80 00 Irrigation ..... 128

32 90 00 Planting ..... 139

    General Design ..... 140

    General Installation ..... 140

    Maintenance Until Final Acceptance ..... 141

    Delivery ..... 141

    Storage ..... 141

    Guarantee ..... 142

32 91 13 Soil Preparation ..... 142

    Topsoil ..... 142

    Pre-Plant Weed Control ..... 143

    Backfill for Shrub and Ground Cover Beds ..... 143

32 91 13.16 Mulching ..... 143

32 91 13.26 Planting Beds ..... 144

32 91 19 Landscape Grading ..... 144

32 92 23 Sodding ..... 144

    Sod Material ..... 144

    Fertilizer ..... 145

Import Topsoil .....	145
Soil Preparation.....	145
Inspection.....	146
Fertilizer Application .....	146
Sod Establishment.....	146
32 93 00 Plants.....	147
Plant Materials .....	147
Approved Plant List .....	148
32 93 43 Trees.....	150
Execution.....	150
Pruning and Repair.....	151
32 94 13 Landscape Edging .....	151
33 Utilities .....	151
Temporary Interruptions of Utilities and Traffic Movement.....	152
Site Utilities .....	152
Water and Sanitary Sewer Service .....	152
Protection of Underground Tanks and Pipes.....	153
Shielding of Equipment .....	153
33 50 00 Hydrocarbon Utilities .....	153
New Natural Gas Service to Buildings.....	153
<b>Appendix A: Peripheral Campus Standards .....</b>	<b>154</b>
UNT Discovery Park Supplemental Standards .....	154
General.....	154
MEP General .....	155
Mechanical.....	156
Electrical.....	156
Data and Communications.....	157
Cable Trays .....	157
Plumbing .....	158
<b>Appendix B: Telecommunications and datacommunications Standards.....</b>	<b>159</b>
UNT System IT Shared Services Standards.....	159
Telecommunications.....	159
Data communications .....	165

Supplemental Information ..... 168

    Closet Track Layout ..... 169

    Jack Terminations ..... 169

**Appendix C: Fire Protection System Specifications ..... 171**

    UNT System Fire Marshall Fire Protection Standards ..... 171

    Underground Fire Sprinkler Main ..... 171

    Fire Protection Sprinkler System ..... 176

    Fire Pumps ..... 187

    Fire Alarm System ..... 198

**Appendix D: Distributed Learning Videoconference room Design Consideration ..... 225**

    UNT Classroom Standards Overview ..... 225

        Facilities Design ..... 225

        Systems Design ..... 225

        Maintenance ..... 227

        Roles and Responsibilities ..... 227

            Decor ..... 228

            Acoustics ..... 229

            Room Type/Furniture Layout ..... 229

        Room system overview ..... 229

            Cost variable accessories ..... 229

        Classroom Instructional System Hardware Cost *Estimates* ..... 230

        Physical Room Characteristics & Other Considerations ..... 230

            Location of doors ..... 230

            Carpeting ..... 231

            Security ..... 231

            Sight lines ..... 231

            Size ..... 231

            Seating ..... 231

            Screen ..... 231

            Data projector installation ..... 231

            Teaching area ..... 232

            Lighting/Electrical ..... 232

            Writing surface ..... 232

Sound ..... 232

Miscellaneous..... 232

**Appendix E: Guide for the Standardization of the Campus Automation System ..... 233**

    UNT Controls and Automation Standards ..... 233

**Appendix F: Interior Signage Standards ..... 237**

    UNT Interior Signage Standards..... 237

**Appendix G: Illustrations, Diagrams, and Standard Details..... 238**

    UNT Design Details..... 238

**Appendix H: Specifications for Construction Project Electronic Deliverables ... 293**

    UNT Construction Project Electronic Deliverables ..... 293

**Appendix I: Transformer Specification ..... 294**

    UNT Medium Voltage Transformer Standards ..... 294

**Appendix J: UNT Facilities Attic Stock Procedures ..... 299**

    UNT Attic Stock Procedures ..... 299

**Appendix K: Guidelines for Land Survey Work ..... 303**

    UNT Guidelines for Land Survey Work..... 303

## PREAMBLE

### Design Guiding Principles

Established in 1890, UNT has served the public and our communities through higher education, helping to fuel the workforce and the economy throughout the North Texas region. As a public university, one of the core values of UNT is accountability to be good stewards of the public's trust and funding. This includes the physical development of the campus as outlined in the Campus Master Plan. In turn, this becomes an overarching guiding principle that also extends to design professionals, construction managers, and any other consultants contracted to perform work for or on the UNT campus through both fiscally responsible, sustainable design and construction methodology and execution. It is the intention that all professionals & others will focus on the following primary key aspects (in order of importance) as the foundational basis for design and construction:

- Provide an environment that is compliant with health, safety, welfare per applicable codes and campus design standards
- Develop and Analyze utility infrastructure requirements and campus impacts beyond the project described boundaries and provide efficient solutions that promote future development
- Develop life cycle costs of resources and materials that will provide efficient, sustainable and effective use
- Meet the university's current mission and strategic goals
- Provide a design that is aesthetically cohesive and inclusive.

### Health, Safety, and Welfare

As required by law to protect the health safety and welfare of the public, all campus building design and construction components must comply with building and life safety codes as adopted by the campus as well as the UNTS Uniform General conditions outlined in the following documents:

- [https://facilities.unt.edu/sites/default/files//docs/memo\\_-\\_unt\\_system\\_design\\_construction\\_codes\\_-\\_rev\\_2019-01.pdf](https://facilities.unt.edu/sites/default/files//docs/memo_-_unt_system_design_construction_codes_-_rev_2019-01.pdf)
- [https://facilities.unt.edu/sites/default/files//docs/unt\\_system\\_uniform\\_general\\_conditions\\_2019-11-19.pdf](https://facilities.unt.edu/sites/default/files//docs/unt_system_uniform_general_conditions_2019-11-19.pdf)

In addition, design professionals and construction managers will adhere to the University Design and Construction Standards (UDCS) contained within this document. Any proposed deviations from the Master Plan or the UDCS are required to be formally requested by the design professional as outlined within the Exceptions and Modifications section of this Preamble.

### Utility Infrastructure

All new buildings, additions or other campus development impacting existing utilities should carefully consider the impact to current and future planned campus or municipality owned utilities serving the project. Utilities include electrical substations, switch gear, meters, power lines, sewer, storm water, gas, data, chilled water, etc. To extent possible the utility connection should tie into campus owned infrastructure.



Of primary importance is careful consideration of efficient use of existing utility infrastructure that supports the new development and careful understanding of the project's impact to and flexibility for future utility expansion. Utility design should also take into consideration a proactive approach for expansion in the future as outlined in the Campus Master Plan.

During the planning and programming stage the design professionals and/or construction managers should evaluate site locations for efficiency, capacity and impact to current utility infrastructure and identify needs and cost for upgrades or additions to the utilities taking into consideration the size, site, and routing as it relates not only to the project, but also future projects as outlined in the Campus Master Plan.

### Efficient and Effective Use of Resources and Materials

Of primary consideration in architectural and engineering design is the use of resources and materials that maximize fiscal, operational, functional and natural resource usage. The delivered design solutions must not only meet the programmatic requirements and be within the allocated construction budget, but also be a fiscal responsible use of public funds through thoughtful applications of pragmatic solutions. Exploration of alternative design solutions that may result in more efficient use of resources or funds is mandatory.

Total Cost of Ownership (TCO) must be a consideration for all projects. This includes, but not limited to, maintenance service and equipment, operational personnel support (maintenance, grounds, custodial, etc.), energy consumption, and other utility costs. In addition, sustainability and flexibility to adapt the building use and/or future expansion is also an important consideration in the selection of building systems and the proposed design. This concept extends beyond immediate energy efficiencies in the facility, but also reuse of existing resources in the future.

The University has limited funds for the operations and maintenance support of the constructed facilities over its lifetime. Selected materials, equipment and design solutions must consider longevity and maintenance costs, life cycle costs, and return on investment (ROI). Untested or overly complicated building system technology that may challenge operational support should be avoided.

### University's Mission and Strategic Goals

All design and construction professionals should familiarize themselves with the current UNT Mission and Strategic goals to ensure the design solutions support these concepts and provide as applicable should enhance the student life and learning experience.

### Aesthetic Cohesiveness and Inclusiveness

The underlying goal of the architectural design of any new construction is to enhance and unify the campus. New construction should relate aesthetically to adjacent buildings and campus elements. Facilities shall be accessible to all and eliminate architectural barriers while accommodating the basic needs of all students, faculty, and staff and support student life and their learning experience.

## Key Master Plan Elements

All design and construction professionals should be familiar with the most current Campus Master Plan and projects should adhere to the guidelines within the plan as applicable. The following are key excerpts of concepts and elements included in the plan. Additional details are contained within the source document and any exclusion in the below content is not a reflection of a lack of importance.

### Planning Framework

The UNT 2013 Campus Master Plan Update emphasizes the sense of PLACE unique to the campus through a balance between open space and buildings. The open space should reinforce physical connectivity with views that enhance the experience of moving through the campus.

### View Corridors

A regulating plan is included in the Campus Master Plan and should be utilized as a tool to guide placement of buildings so that the cohesiveness of the underlying campus organization and urban design fabric is maintained. The regulating plan is not as rigid as typical zoning setbacks. It is flexible in all aspects of building layout and placement except for protecting view corridors on campus.

- The Hurley Administration Building is a campus landmark and direct views to and from the McConnell Tower should be maintained. Views from the Gateway Center to the tower (on the diagonal originally envisioned in the 2002 plan) should be protected, and new buildings should frame this view or be low enough not to block it. North of the Hurley Administration Building, the Avenue B Mall should be extended to the campus edge and a new pedestrian gateway created to reinforce this important pathway. To the south, the extension of the Library Mall should be framed to protect this critical view corridor.
- Future buildings along the Library Mall should define the edge of the mall space.
- Highland Street will become a major cross-campus corridor and central wayfinding element. The mall space should have a well-defined built edge (see build-to-lines) framed by the linear progression of street trees and lights. To reinforce this east-west corridor across the campus, the plan extends Highland west of North Texas Boulevard. A new landmark building with a tower element terminates the western end of this route, and marks the campus edge on I-35 at Bonnie Brae.

### Building Setbacks

Where the Regulating Plan does not identify build-to lines or specific setbacks, buildings should respond to the context of the immediate site and align with adjacent buildings, especially along existing campus streets and major pedestrian spaces such as plazas, malls, and walkways. Long continuous or uninterrupted walls are not suggested. Massing related to the surrounding context that provides a sense of scale is encouraged. Some variation in the building face (both encroachments and setbacks) to add focus to the entryway, places for informal gathering and enhanced landscaping are seen as assets. However, in no case should these variations or encroachments block identified views or view corridors.

### Building orientation

In general, an east-west building orientation is more energy-efficient in providing shading to reduce solar gain while maintaining interior daylighting. But the building placement and orientation, as illustrated by the master plan, is governed more by the campus open space and urban design objectives,

to define outdoor spaces or to relate to adjacent buildings. Where a north-south orientation is required, the design of the building envelope, solar shading or screening, site trees and landscaping should respond to the local climatic issues for optimum energy efficiency.

### Building Form & Massing

Building plans should be simple in geometry, avoiding excessive width, mass or overly complex shapes. Building use and program should suggest the floor plate size and depth, but optimal dimensions should maximize daylighting and natural ventilation opportunities.

When wider floor plates are required for functional and programmatic reasons, the building designer should seek other approaches to bring natural daylight into the buildings, including analysis of options such as courtyards and atriums.

Existing campus buildings that respond to the campus grid and successfully define outdoor spaces tend to be simpler in massing, focusing attention on entrances, quality materials and detailing. Smaller elements such as bay projections, arcades, porticos and covered walkways are encouraged to shape outdoor campus spaces, connect to sidewalks and building entrances and provide a welcoming human scale.

### Building Heights

Building heights on campus should be three or four stories in most locations. Taller buildings may be appropriate in some locations to support additional campus density, accommodate programmatic needs, or achieve landmark status (such as the iconic building on Bonnie Brae or future buildings along I-35), but should not obscure views of the McConnell Tower in the center of campus. One-story and two-story buildings are discouraged, especially in the central core of the campus.

### Building Facades and Fenestrations

#### Existing Traditional Buildings

The traditional buildings of the campus exhibit the qualities of a well-ordered facade, with a clearly defined base, mid-section and top. They are organized around a central entry feature with a proportion of window to wall area well under 50 percent. The best traditional buildings exhibit a greater proportion of wall area, which improves comfort and energy performance. Windows are expressed as punched elements in a continuous brick facade. They are generally vertically proportioned and have expressed surrounds with a strong sill and lintel. Keystones are often used, with or without expressed arches. Windows on the ground floor tend to be more ornate in design, with many incorporating arched elements or unique stone ornament, and often an expression of a cornice tops the first floor.

#### New Buildings

Facades should be similarly ordered and regulated with a well-articulated base, mid-section and top (see the diagram below). The base should be expressed as the foundation of the structure, defined by a differentiation in material (stone being most common), window size and placement, with larger lintels, quoins or other horizontal stonework integrated with the window surround and trim.

The middle section should be simpler in expression and detailing, with repetitive windows, trim and detailing. The top should be defined with a horizontal detail or cornice, creating a strong profile against the sky. The top floor may also be given an additional expression, with a horizontal delineation, change in color or materials and/or a unique window treatment. Order and rhythm should be expressed

through regular placement of windows, traditional detailing and a consistent definition of the roof or parapet line.

Future buildings need not be simplistic copies of traditional buildings. Instead, they should draw from the lessons offered by successful campus buildings of the past, while responding to contemporary program requirements within the campus context. New buildings should respect the surrounding context and adjacent buildings in terms of mass, height, proportion and materials, and the spaces they create.

Facades require attention to glazing and shading to meet energy efficiency standards and UNT's goals for sustainability. Designers are encouraged to develop responsible solutions in the spirit of the best traditional buildings on campus. Facade details which add depth also create shading and can be used to unify the facade and provide a sense of scale through horizontal and vertical expressions. Shading elements should not appear as large or independent structures that encompass the entire facade or as tacked-on screens or shades; rather, they should be incorporated into the facade fenestration and design of the windows. All new buildings should seek to reduce solar gain through building orientation. They should use strategies such as minimizing west facade glazing, using deeply recessed and shaded windows or bays on the south side, and opening the facade to bring in daylight on the north side.

### Architectural Design

While each proposed new building project and site should reflect the careful application of the previously stated characteristics, the following elements should be carefully considered in the design process to further promote and develop a level of consistency and distinct context for projects developed in the campus environment. These design characteristics speak to an enduring campus experience without promoting a rigid recipe.

### Appropriate Materials

#### **Brick**

The UNT campus character relies heavily on masonry brick as a unifying material for the campus, and brick will continue to be the primary building material. Brick offers a range of colors, surface textures and patterns, but the predominant bricks on campus are the locally produced, light-colored units with a slim proportion. New buildings may be built in any of four UNT standard brick colors from the Denton Acme Plant: Burnt Pumpkin, Golden Sunset, Ridgemar and Royal Oak.

New buildings are not limited to replication of traditional brick patterns, but can add interest and scale with raised courses, vertical reveals and coursing changes. A mix of complementary colored brick can be very effective, especially when surrounding buildings are constructed of different bricks. Patterning should be used cautiously and harmony with adjacent buildings must be considered. The goal is to use subtle variations thoughtfully in the masonry to add scale and interest while reinforcing a consistent campus character.

#### **Stone**

Smooth finish stone is used to define building base conditions and trim, complementing the traditional brick throughout the campus. Stone is a more expensive material, reserved for areas of focus, acting as a

visual “frosting” of decorative detailing at major entrances, cornice lines and quoins. New buildings should consider where stone accents would be most appropriate, such as for window lintels and sills and at major entrances. Given the expense of quarried limestone, alternatives may be considered including use of stone veneer and cultured or manufactured stone, precast concrete and limited areas of exterior stucco-plaster (all should be detailed appropriately and should not look stuck-on). Use of lightweight synthetic or faux stucco or brick (including EFIS) is unacceptable.

### Metal

While metal is used sparingly, if at all, on the oldest campus buildings, metal has come to serve the same function in modern construction as wood and stone, providing window and door trim, cornice and parapet caps and decorative accents. Metal can be part of a glazing system at entrances and atriums, and may be an option for roofing in unique circumstances (such as the Murchison Performing Arts Center). But large areas of panels are not appropriate to the campus context and vocabulary and so metal is unacceptable as a major exterior wall material.

### Glass

Glazed openings, both detailed windows and larger entry or lobby glazing, improve natural lighting and, most importantly, demonstrate activity and vitality occurring inside and outside buildings. Large areas of glass can create challenges for energy efficiency, and therefore should be limited or discouraged on south-facing or west-facing facades, and used appropriately for the purposes above. Glass and glazing systems should be insulated, high performance, and energy-efficient; light tinting is acceptable for efficiency but highly reflective glazing should be avoided. Large areas of glazing without relief, mullions or other expressions of scale are unacceptable.

## Architectural Elements to Include/Avoid

### Rustication

Normally positioned at the base of buildings, rustication gives visual weight to the structure by expressing the strength of the foundation.

Visually reinforcing horizontal lines at the base can be achieved through stone or masonry bands and courses. Historically, large masonry blocks with deep joints created a strong anchor for buildings. The same effect can be achieved through different materials, rougher surfaces and larger masonry components than the upper portions of the structure. On the UNT campus, rustication is a consistent device spanning from the earliest building to the newest, enhancing the street level of the buildings and adding texture and human scale to the exterior space.

### Quoins

Quoins emphasize the character and scale of building corners. Traditionally, dressed stone quoins created the ends of large fields of masonry on facades.

On the UNT campus, quoins take on many different expressions: stacked, rusticated or ashlar stone blocks (Chilton Hall); or simpler expressions (Bruce Hall), which both reference classical quoins. On other buildings the quoins have become vertical corner caps (Legends Hall, at right) and this is also an acceptable expression.

New buildings should provide material changes to create corner emphasis or develop quiet reliefs between fields of materials. In particular, new buildings should integrate quoins into their designs to complement adjacent buildings with such details.

### Colonnades and Porticos

A portico is a porch leading to a building entrance. As an extended portico, a colonnade composes columns or piers to support horizontal elements including an entablature or multiple arches. On the UNT campus, this architectural device defines entries, provides shaded connections, reinforces the horizontal building base and captures desirable indoor-outdoor space. Elegant proportions, appropriate scale along with placement at areas of activity and where shade is especially desirable, will create the most successful applications. New buildings should use colonnades, arcades and porticos when appropriate, especially to connect with landscaped open spaces and walkways. New buildings adjacent to older buildings should be aligned per recommended setbacks, so as not to obscure or hinder view lines to existing historic colonnades.

### Arched Entry

Using a curved lintel or an actual arch can emphasize and depict important entry points. Across the campus, a wide variety of gateway and entrance solutions, styles and detailing exist. The most successful feature an appropriately-scaled arched element to signify an important destination. Not all entries require this level of celebration, so the scale of the entrance should be respectful of the building's function and context. New structures with differing scales and visible uses should consider arches, soft curves, axial alignments and similar devices to create a sense of scale and connectivity.

### Glass Entry

Creating a sense of transparency from outside to inside is made possible by incorporating glass doors into a larger field of glass.

Typically located at the primary entry, lobby or an atrium, glazing used appropriately can enhance exterior-to-interior connectivity. It can improve daylighting and transparency, facilitating display of interior functions and activities. In buildings opening onto major green spaces or with special views, this element can be used as a framing device, creating a large 'picture window' to the exterior. Glass entries can also be used to connect buildings of different time periods. Design attention must be given to the integration of entry doors, glazing and mullions or support system, with the scale, proportions, depth and detailing of the overall building.

### Window Fenestration

Fenestration is the arrangement, proportioning and design of windows and doors in a building's exterior walls or envelope. Windows, and the detailed method of their trim and surrounds, are another signature element of the architectural vocabulary on campus.

The most basic design of fenestration and window design involves both scale and composition. At the base of buildings, the windows should establish a clear and regular rhythm. On the upper portions, they may be grouped vertically to suggest a procession of columns or used as a horizontal series to emphasize long roof lines.

The scale of the individual windows and the pattern of mullions can be diverse in expression, but always requires an expression of depth and detailing. On older campus buildings, glazing panes are broken

down in size with mullions and many historic windows have multiple sash configurations. Color choice also plays an important role in reading the mullions, with lighter colors preferred for greater definition. Framing the window itself provides an opportunity for interesting detailing, through lintels, jack arches or similar detailed treatments. The lintel detail may include a change of pattern or materials, such as soldier courses or stone lintels, trim and sills. The intent is not to imitate historic details, but to appropriately use detailing to provide scale and depth of expression, so that new buildings relate well to existing buildings. Over-simplified fenestration, with mullion-less windows or windows with thin frames and no depth or relief are unacceptable.

### Cornices and Roof Edges

Defining a roof edge supports development of a consistent campus scale and building-to-building relationships. On the UNT campus, strong horizontal roof edges exist in many configurations, from very subtle parapet caps to highly-detailed cornices with soffits. Roof edges are given expression, whether the roof is sloped or flat, and in many campus buildings, verticality is expressed by extending the wall beyond the cornice with a simpler parapet cap.

Infill buildings should relate to these existing edge lines; and all new buildings should give design definition to the roof or parapet edge with some form of cornice and/or cap.

By changing materials and varying their depth, new buildings have many opportunities to create well-defined roof edges. Deeper cornices or overhangs are encouraged in lower buildings as shading devices and in larger or taller buildings to give definitions to their height.

Roof edge and proportions also have an integral relationship with the building base. These two important architectural devices should have an inherent balance and complementary dialogue.

### Sloped Roofs

On this campus, most buildings combine low sloped roofs, typically gabled or hipped. Some include areas of flat roof with parapets. Sloped and hipped roofs are an important component of the campus architectural vocabulary. Low sloped roofs are encouraged, appropriate to this region which does not get large amounts of snow or rainfall.

Material and proportion of sloped roofs helps to dramatically improve building scale and create familiar forms and character. Infill buildings especially must relate to the roofs of adjacent buildings in type, slope and materials.

Not all functions can be accommodated with sloped roofs; nor are all building systems able to accommodate sloped roof conditions. However, in all cases, roof slope will be carefully evaluated for consistency and sensitivity to the campus character.

### Landscape Architectural Design

The purpose of the landscape architectural design guidelines and standards is to encourage consistency and visual unity in the overall development of the campus. They do not prescribe specific designs for the campus, but rather, establish a design direction and performance objectives for landscape treatments. The goal is to achieve a comprehensive campus landscape design that is economical and practical to

maintain, responds to functional and environmental constraints, and in which all parts of the campus landscape relate to each other to establish an integrated whole.

### Structure/Space Definition

The overall spatial organization of the campus landscape is primarily determined by three major components - buildings, topography and woody plants consisting of trees and shrubs. Paths and roads also play an important organizing function; however, their role is somewhat subordinate to the three-dimensional strength of the buildings, land, trees and shrubs. The limits, emphasis and character of all views within and around the campus are defined largely by these elements.

Planting is often considered in terms of its decorative effects within a man-made landscape. It is often said that plants are employed to “soften” the look of large buildings or extensive areas of pavement. While it is true that the shapes, colors, textures and biomorphic forms of plants have a pronounced influence on the quality and character of the landscape, the principal role of plants is to define the shape, size, sequence and hierarchy of outdoor spaces in keeping with large university buildings, streets and parking lots.

This space-defining role of plants is fundamental to the overall conception of the landscape and should precede thinking about specific plant characteristics such as flower, leaf texture or branching habit. Plantings should, therefore, be understood as three-dimensional elements that can be composed to define the basic spatial composition of the campus, which in turn, affects the quality of campus life.

Trees and shrubs should be considered in terms of achieving desired functions and spatial effects, such as limiting or directing views, creating microclimates, creating overhead enclosure for shade or greater intimacy, framing spaces to create compositional closure, modulating the scale of large buildings or to define and reinforce major spaces, streets and pathways of the campus.

This approach recognizes that the overall spatial order and quality of campus spaces are principal concerns of campus design. The buildings and plantings of the campus assume broader meaning only by virtue of the way they are arranged in relationship to each other and the order of spaces they create together. While individual buildings or plants may possess characteristics that are attractive in themselves, the emphasis of campus design should be on the larger relationships of formative elements to space.

### Scale

The size of tree groups, shrub masses and plant beds should be considered with respect to their relationship to campus buildings, roads and spaces. Plantings that are too small or spotty in relationship to large buildings can appear out of place in the larger scheme of campus design. In general, plantings should be simple rather than overly intricate. They should be conceived in broad strokes that are appropriately scaled to their surrounding and the larger campus. Smaller, garden-scale plantings and flower beds are important to the campus; however, they should be properly related to the campus through hierarchical relationships.

### Plant Character

Plants selected for the campus should be long-lived, relatively pest-free and, to the practical extent possible, native to the north central plains of Texas and Cross Timbers Bioregion. Such species will, in



most cases, enhance the possibility for long-term adaptation to the campus environment and create a visual setting that harmonizes with the characteristic landscape of the Denton area.

Non-native plants may be used on the campus. However, they should be noninvasive and possess visual traits similar to native flora. Plants whose visual appearance is divergent from the native flora should not be used on campus, even though they may be in fashion from time to time. They include horticultural varieties with unusual form or color characteristics. Exceptions to this rule, such as special flower beds, should only be permitted in unique circumstances and the exceptions should be few.

Campus plantings should capitalize on the intrinsic beauty of native flora. The design of the plantings should be simple and seek to evoke a mood of tranquility similar to the bold compositions found in nature. Compositions with too much variety and fragmentation result in busyness, constantly diverting the eyes with one unique element after another. Therefore, the campus design should generally be kept free of distracting elements that do not harmonize with the whole. This approach will result in a campus landscape that is regionally appropriate, sensitive to water conservation, dignified and practical to maintain.

The natural form and character of plants, particularly shrubs, should be retained through proper design and pruning. With the exception of hedges, shrubs should be planted in arrangements that allow for their natural shape to be retained and allow adequate space for them to develop to their natural size either as individual elements or in merged masses. When plants are too large for the space that is allowed for them, shearing is necessary to keep them in bounds. Continuous shearing destroys the natural form of the plants, incurs ongoing maintenance costs and results in an unintentional design that often adds little to the overall campus design.

### Plant Patterns

The University of North Texas landscape consists of both geometric and naturalistic planting arrangements. These two types of planting patterns should continue, with the geometric arrangements employed along campus streets and major pedestrian malls such as Avenue B and Library Mall. Naturalistic arrangements should be employed throughout the larger spaces of the pedestrian academic core and the Eagle Point campus. Most street tree planting zones are sufficiently constrained with utilities and pavements so that rows of trees are the only practical option. Such geometric rows of trees provide a memorable sense of order that amplifies and dramatizes the linear organization of street pavements and curbs.

A formal planting pattern is also appropriate for the Avenue B and Library Mall where space is limited, pavement requirements are high and the symmetrical order of the Hurley Administration Building argue against a naturalistic planting approach. Symmetrical patterns are appropriate to frame the entrances to major buildings that have symmetrical architectural treatments.

For most pedestrian areas, however, naturalistic patterns of trees and shrubs should be the dominant landscape expression. Informal, naturalistic groves of trees have graced the campus since its beginning and this landscape approach should continue. Naturalistic arrangements offer the advantage of compositional wholeness that can be achieved in many ways; layouts can easily adapt to utility and drainage and access requirements. The planting can be sufficiently diverse to accommodate a variety of species and ages of plants while maintaining an overall sense of completeness and order.

For both geometric and naturalistic planting arrangements, it is recommended that plants be organized in groups composed of single species or multiple species that share a high degree of visual similarity. Groups of similar plants are important because they visually tie the campus together, often overcoming the incompatibility of various architectural styles and treatments.

Planting often is the “glue” that visually connects one part of the campus to another. It can fulfill this function if there is sufficient repetition of species and excess variety is restrained. For example, a single block of any given street should be composed of a single species of street trees to ensure linear continuity. Single species may successfully extend for more than a single block as well. Good existing examples of harmonious tree groupings are the Post Oak grove in front of the Auditorium and the Cedar Elms west of the University Union. The bed plantings north of Matthews Hall, on the other hand, tend to be too intricate and complex for the sizes of the landscaped space and adjacent building.

### Specific Area Character/Guidelines (including edges)

#### *Library Mall & Extension South*

As one of the most frequented and symbolically important pedestrian spaces on the campus, the Library Mall should follow the intent of the Library Mall Master Plan.

Landscaping in the Library Mall should create tree canopies along both sides of the mall, a new grove on the north side of the library and ground-level plantings to enrich and unify the pedestrian environment. The large Live Oak, Hackberry and Cedar Elm trees at the south and north ends of the mall should remain. The primary trees lining the extension of the mall going south should be also be Live Oaks. The grove to the north of the library should be Cedar Elms to match the grove on the opposite side of the mall in front of the University Union.

#### *Campus Grove*

The historic campus groves, composed principally of Post Oak, should be maintained and reinforced. The objective for these areas should be to perpetuate the high canopy and raise the canopy where needed to improve sightlines and visibility.

The campus tree canopy plays a significant role in moderating the microclimate of the campus by decreasing heat build-up in pavements and buildings and through the cooling effects of transpiration.

In the climate of northeast Texas, with its summer extremes of heat and drought, groves of trees are a more appropriate landscape expression for university grounds than large, open, turfgrass quadrangles found on campuses in the temperate climates of the Atlantic coast regions.

While some open lawn activity areas are necessary for events and informal play, they should be the exception rather than the rule on the UNT campus.

Maintenance and reinforcement of the groves should include the evaluation and protection of existing trees and scheduled additions of new trees to replenish losses and plan for the future. Protection of existing trees may include groundcover plantings around mature trees to prevent heavy foot traffic on their root systems.

Post Oak should continue to be the principal species in the existing groves. Particular care should be given to preventing damage to the root systems of existing trees. Post Oaks are very sensitive to changes in soil compaction, soil moisture and root disturbance. While Post Oak is a difficult species to transplant, the addition of new Post Oaks to the existing stands should be considered. Adding new Post Oaks would diversify the age of existing stands and be insurance against possible future losses of existing mature trees. Because digging of Post Oaks from the wild or from nurseries is probably not realistic, consideration should be given to container growing Post Oaks and setting the trees out when they are 3/4 inch to 1 inch in caliper size.

The new groves indicated on the master plan consist of native canopy trees with proven ability to adapt to the soils and climate of the campus. Species may be mixed; however, each grove area should have a single dominant species that unifies the planting. For example, one grove may be characterized by Shumard Oak, another by Live Oak. This diversity of species used campus-wide will create a variety of tree canopy areas across the campus, each with its own unique character. The installation size and horizontal spacing of trees should be varied.

Existing groves should be used as a model for determining a random naturalistic spacing pattern. The typical error encountered in the layout of groves is to plant the trees equidistant from each other at a distance of about 30 feet. This spacing yields a uniform pattern that is not naturalistic. A conscious effort is needed to replicate natural patterns in which the trees may vary from ten to 50 feet apart. A variation of tree sizes at installation will further enhance the naturalistic effect. Proper preparation and planting methods should be utilized to ensure the health of the trees.

Species suitable for new campus groves include the following:

- Large Shade Trees
  - Live Oak
  - Bur Oak
  - Chinkapin Oak
  - Cedar Elm
  - Lacebark Elm (Drake, Allee)
  - Crape Myrtle
- Medium/Small Shade Trees
  - Crape Myrtle
  - Mexican Redbud, Texas Redbud
  - Tree Yaupon Holly
- Other Campus Trees
  - Post Oak
  - Shumard Oak
  - Texas Red Oak
  - Pecan
  - Possumhaw Holly
  - Desert Willow
  - Mexican Plum
  - Bald Cypress
- Street Trees
  - Live Oak (recommended for perimeter streets)
  - Bur Oak

- Chinkapin Oak
- Cedar Elm
- Lacebark Elm (Drake, Allee)
- Planted Medians
  - Natchez Crape Myrtle (Tall tree, White)
  - Muskogee Crape Myrtle (Tall, Light Lavender)
  - Tuscarora Crape Myrtle (Broad Vase, Dark Pink)
  - Tuskegee Crape Myrtle (10-20', Broad Spreading, Dark Pink)

*Campus Edges, Perimeter Streets, and Other Characteristics*

A consistent landscape design using the same species of shade or ornamental trees will greatly help tie together the various developments (buildings, parking areas, and open space) along the perimeter of the campus and provide the continuity needed to make the campus edge distinctive and easily recognizable.

Campus perimeter streets, including Hickory, Welch, Eagle, North Texas, and portions of Mulberry, Bernard, Prairie and Bonnie Brae should be included in a street tree revitalization program. Street trees should be a single species of shade tree, planted at 40-foot intervals.

Street Tree Grates should be used to facilitate pedestrian movement where sidewalks are along the curb edge (see the recommendations for a UNT standard street grate).

Sidewalks should be widened if necessary to maintain an ADA compliant clear path (6-8 ft is preferred).

This plan recommends the use of Live Oak for the campus perimeter street trees.

Where large parking areas are adjacent to the campus perimeter, ornamental flowering trees of a single flower color and species should be added to compliment the larger shade trees.

This plan recommends the use of the white flowering Natchez Crape Myrtle for these areas.

All street entrances to the campus should include a planted center median to further define the campus entrance.

UNT standard pedestrian-scale street lights should be provided, in addition to City or County roadway lighting.

Street light poles should have banner arms, and banners should be maintained with a regular program of banners for UNT events.

All entrances to the campus should be identified with signage and landscaping. UNT should develop a consistent approach to signage and identity along the perimeter.

Surface parking lots that abut a public street should be screened by additional landscaping, such as a solid hedge, berm or a wall with a height of 30"-48". The standard university brick should be used on screen walls.

## Half-Percent for Art

- One half-percent of the estimated total cost of each capital project involving new construction that exceeds one million dollars (\$1,000,000.00) must be allocated to develop architecturally integrated public artworks of the highest quality for placement in or in the immediate environment of the facility being constructed.
- Each new capital building that exceeds five hundred thousand dollars (\$500,000.00) but is less than one million dollars (\$1,000,000.00) must have an allocation of one half-percent of the estimated total cost for the purchase; or commissioning of individual artwork for the site; or for the immediate environment, including installation costs; and adaptation of the environment to accommodate the artwork.
- Funding and expenditures are subject to conditions or requirements established by law, regulation, gift agreement, University policies and/or Regents Rules. Projects funded by local funds other than private donations are included in the half-percent for art requirement unless otherwise determined on an individual basis by the President or their designee.
- The president or their designee retains the authority to exempt a project from the one half-percent allocation requirement.
  - Exempted Capital Projects
    - capital projects that are infrastructure improvements, cosmetic improvements, maintenance, or demolitions only. Examples of these projects include but are not limited to: interior cosmetic renovations, mechanical, electrical, plumbing, maintenance and equipment upgrades, or installations;
    - the portion of a capital project funded by private donations is exempt from the Half-Percent for Art allocation unless otherwise determined on an individual basis by the Advancement Office;
    - new capital projects funded by student fees and auxiliary reserves; and
    - when the president determines that it is in the best interest of the University to exempt a capital project.

## Exceptions and Modifications

Particular project situations shall, in the judgment of the designer, warrant deviations from these standards. We welcome such recommendations and shall consider each of them carefully. However, unless the University gives specific approval for alternatives prior to implementation, the Designer must comply with the guidelines in this publication.

There is a formal mechanism to request exceptions or modifications to this document.

Complete the **Design and Construction Standards Exception Request form**, located on the UNT Facilities website under Resources > Forms and Document Library > Projects and Renovations section:

<https://facilities.unt.edu/>

Send complete forms to [UDCS@unt.edu](mailto:UDCS@unt.edu).



## PLANNING

### General

#### Designer's Relationship to the University

Refer to Article 4 of the UNT System Uniform General Conditions.

The Designer should understand that all UNT buildings are under the authority of the University President. UNT Facilities is responsible for the operation and maintenance of all buildings and therefore is considered the “Owner” – even though project planning and design for the University is a cooperative procedure involving many persons within the UNT System, campus, state agencies and other reviewing authorities.

At any point in time there is a single representative assigned to each project. This is the person through whom the Designer is required to work and to whom the Designer should turn for authoritative information on all matters and questions involving the University. Many other individuals and groups within the University will participate in the capital improvement planning process, but the Designer should not act on any information other than that received from, or coordinated through, the designated project representative – herein referred to as the Project Manager.

The Project Manager is the contact for all information during the initial phases of a project – programming, designer selection, design, and bidding. This individual coordinates and monitors all project activities for the University. The Designer shall designate an individual within their firm who is directly responsible for the project, and who can be contacted on any matter pertaining to the project.

#### Building Address

The UNT Facilities Associate Director of Facilities Planning, Design and Construction establishes new building addresses for the Denton campus in coordination with the City of Denton.

#### Initial Planning Conference

As soon as possible after the selection of a Design Professional for a project, an initial planning conference will be scheduled to discuss general requirements of the program and procedures for facilitating the Designer's work. The Design Professional's consultants should attend this conference as necessary.

#### Project Development Schedule

The Designer shall prepare and submit a proposed Project Development Schedule to the Owner's Project Manager for approval. This schedule shall contain:

1. The start dates and duration of each major phase of design.
2. The duration and completion dates of each design review period required to maintain the project schedule.
3. The projected duration and completion dates of other project-related activities, such as funding decisions, surveys, sub-surface investigations, permitting, and zoning approvals.
4. The estimated duration of the construction contract award process and the construction period.

The Project Development Schedule is up-dated and re-submitted with each end-of-phase submittal described below.

### Review of Design

The Designer is required to make submittals and presentations, and to participate in review conferences at various stages of the project planning process.

### **Presentations and Review Conferences**

During the design process, the Designer is expected to make presentations to various groups who must review and approve the proposed project designs. These groups include the user group, various groups of UNT System and campus Facilities, other officials of the University, and the Design Review Board of the University. The Project Manager schedules all conferences and presentations.

### **Schematic Design Conferences**

Normally several conferences precede the approval of Schematic Design documents. Conferences are required to clarify the program of requirements, to review and discuss the Designer's design proposals, to discuss the Designer's evaluation as to whether the program requirements are achievable within the project budget, and to assist in the definition of alternates, which shall become an important component of the Construction Documents.

The Designer may be asked to make a presentation of the project design to the Finance and Facilities Committee of the UNT System Board of Regents for their comments and approval. The following exhibits are typically required for these presentations:

1. A simple scale model showing the siting and vicinity of the project (except for renovation projects)
2. The building floor plans
3. The exterior elevations and possibly a sketch or rendering.

These presentations are scheduled to occur as early as possible in the Design Development Phase of project.

### **End-of-Phase Reviews**

At least one conference is devoted to the end-of-phase reviews of the Design Development submittal and Construction Documents submittal for the purpose of discussing any areas of concern that arise during the review process. The Designer and the Designer's primary consultants are expected to attend these review conferences.

### **Conference Memoranda**

The Designer is expected to record the content of all conferences and, within seven (7) days, provide a memorandum containing a complete summary of the decisions and actions that will affect the project. This memorandum is distributed to all attendees.



### Submittals for Outside Review

The Designer shall submit plans to all appropriate agencies for review, permitting, and approval, except as noted below. The Designer is required to provide the background and technical materials necessary to support these submittals; including a storm water management plan, erosion control plan, and/or traffic control plan. The Designer shall attend public hearing(s) related to these submittals, as required.

For projects >1ac that don't go through the pre-con process, please provide the following via email:

- 1) Contact information for project manager/superintendent (name, phone number, email address)
- 2) Location of project
- 3) Anticipated start date of project (if known).
- 4) Erosion control plan for the site if available.

Send above information to:

[watershed@cityofdenton.com](mailto:watershed@cityofdenton.com)  
[joetta.dailey@cityofdenton.com](mailto:joetta.dailey@cityofdenton.com)  
[zachary.peterson@cityofdenton.com](mailto:zachary.peterson@cityofdenton.com).

### Submittals for University Review

In addition to the various state and local agencies that may exercise plan review authority over the project, various departments within the University also participate in plan reviews at stages specified in the Designer's contract. The University's Project Manager shall coordinate these reviews.

The University review team will submit comments as necessary. Upon receipt of the review comments, the Designer shall revise the Design Documents in accordance with the review comments. The Designer shall prepare a written summary of his or her response to the University's review, and the Designer shall provide a copy of this to the Project Manager within two weeks of the Designer's receipt of the review comments.

The Designer shall not proceed to the next phase before receiving written approval of the previous phase from the University's Project Manager.

### Payments to Designer

The Designer shall submit invoices per the UNT System Procurement department rules. All inquiries should be directed to the UNT System Business Service Center.

### Project Development Phases

Below is an overview of each phase, which may vary by project.

#### Schematic Design Phase

At the beginning of the Schematic Design Phase, the Designer shall confer with the Project Manager and the users to review the program and establish the project requirements. Based on an approved summary of the project requirements, the Designer shall prepare a Schematic Design illustrating the recommended implementation of the program and project requirements.

The Designer is expected to involve the assigned Project Manager – and through that individual, the user group and other appropriate members of the University's Facilities – during the development of the schematic design. The Designer is expected to explore a range of alternatives that best implement the program and project requirements.

The UNT Project Manager shall involve Space Management staff and the UNT Facilities CAD Manager to consult on the generic naming (e.g., Conference Room, Classroom, Lounge, etc.) and numbering of rooms.

### *Schematic Design Submittal*

The Schematic Design Submittal to the University shall be per contract or as discussed prior to submittal. Include the following information as a minimum:

1. Show proposed walkways, vehicular and service access on the site plan. Include existing landscape.
2. Identification of each room or space by functional name on floor plans.
3. An updated Project Design Schedule.

### **Design Development Phase**

Based upon the approved schematic submittal, the Designer shall prepare the Design Development documents.

### *Design Development Submittal*

The Design Development Submittal to the University shall be per contract or as discussed prior to submittal. Include the following information as a minimum:

1. Site drawing(s) showing adjacent buildings, significant existing features including existing landscaping, site utilities, proposed construction limits, proposed site improvements, and other site data furnished on the previous submittal.
2. Floor plans shall identify each room or space by name and number. All room numbers must reflect the permanent room numbering signage system. The University will establish the room numbering system prior to committing to the drawings.
3. Elevation drawings of every exterior side of each structure showing materials, features, openings, floor and rooflines, grade lines, footings, and everything exposed to view above eaves or parapets. Show partial elevations of adjacent campus buildings on elevation drawings.
4. Section(s) through the entire building selected to best show the relationships of architectural and engineering features.
5. A room finish schedule showing the type of material to be used for floors, walls, and ceilings. The proposed interior finishes concept shall be presented to the University for approval. The University must approve all finish materials selections prior to their specification by the Designer. This shall include concepts for the following:
  - a. All floor material types and locations.
  - b. All wall finish materials and locations.
  - c. Identify exterior materials, including wood species, brick and/or stone.
  - d. Identify millwork locations and materials
  - e. Identify ceiling materials and locations.
6. Equipment and furniture layouts for all rooms indicating the adequacy of the arrangement and configuration of such rooms for planning telephone and data requirements.

7. An outline specification indicating materials, types of construction, and equipment to be used. Include a description of each plumbing, HVAC, fire protection and electrical system design concept. Include elevator characteristics, and include the names of proposed manufacturers of HVAC, plumbing, fire protection, special systems, electrical equipment and fixed equipment.
8. The maximum hot water and chilled water demand for the purpose of determining whether the existing heating and cooling systems will be adequate to meet anticipated demand or whether modifications to these systems or a new stand-alone system will be required.
9. A tabulation of building data, including square feet of floor area, cubic content, roof deck "U" factor, heating load in BTUH, air conditioning in tons, plumbing load in drainage fixture units, water demand in peak GPM, electrical loads in KVA, the design live loads and number of occupants.
10. An up-dated Project Design Schedule.

### Construction Documents Phase

Based upon the approved Design Development Submittal and written notice to proceed, the Designer shall prepare the Construction Documents. As stated in the Designer's contract, the building design must be in compliance with all applicable codes, laws, ordinances, and regulations.

1. Owner's reviews of Working Drawings are required at stages per the Designer's contract.
2. At 50% and 100% Final Construction Documents, provide the Project Manager with electronic floor plans in AutoCAD format that include electrical, data, and intended furniture layout.

### *Final Construction Documents Submittal*

The Final Construction Documents shall be prepared as per contract or as discussed prior to submittal on sheets specified.

The first sheet of drawings shall include a tabulation of building data including:

1. Square feet of floor area
2. Cubic content
3. Roof deck "U" factor
4. Maximum heating load in BTUH
5. Air conditioning in tons
6. Plumbing load in drainage fixture units
7. Water demand in peak GPM
8. Electrical loads in KVA
9. The design live loads
10. Number of occupants
11. Applicable codes, laws, ordinances, regulations

Provide two "finish boards" accurately depicting the interior and/or exterior materials, colors and finishes used on the project as well as their location within the project. The University must approve all material selections prior to submittal of a "finish board."

Provide an accurate Project Design Schedule.

### Bidding Phase

Coordinate all bidding through the UNT Project Manager and UNT System Business Service Center.

## DESIGN

### Campus Design

The underlying goal of the architectural design of any new construction is to enhance and unify the campus. New construction should relate to adjacent buildings in character, mass, dimension, scale, building materials and fenestration.

The Designer must consider the impact of new construction on the existing campus infrastructure. This includes careful consideration of the project's utility, pedestrian, parking, vehicular access and open space requirements. The project development must be consistent with the vehicular/pedestrian open space and utility systems proposed in the campus master plan.

The design must also consider the long-term health and retention of mature tree specimens on campus. Do not design any utility lines to be installed under tree canopies. If any trenching absolutely must occur under any tree, then utilize AIR SPADE trenching technology.

For projects on peripheral campuses refer to the Supplemental Design Standards in Appendix A.

### Design within Available Funds

Designers shall base designs upon the budgeted funds available for construction. If at any time the Designer believes that satisfying the stated program requirements at the level of quality desired will exceed the budgeted funds available, they must inform the University's Project Manager without delay.

The Designer shall continually monitor program requirements and cost estimates to assure that the project is designed within the available funds and does not deviate from the quality standards established herein.

### Flexibility by Design

Recommended building heights are limited to three stories, and shall not exceed five stories. Where expansion at a later time is considered, lateral, rather than vertical expansion is recommended.

The Designer is encouraged to locate stairs and elevators on the periphery of the building to allow large blocks of continuous space inside the building. Flexibility of future use favors the creation of large free span areas of monolithic surface, so long as the design can carry the load.

Avoid split-levels floors, depressions or elevated floor sections.

Flexibility in the arrangement and use of a building is a fundamental requirement, and the ability to accommodate growth and change is an important criterion in the selection of materials and the design of the structural, mechanical, and electrical systems.

### Maintainability and Access

Designers must consider long-term durability and maintainability when selecting and specifying equipment, materials, and finishes. Initial cost is not the over-riding consideration. No exterior part of the building should have any surface that requires painting.

Designers shall comply with OSHA regulations for employee access to equipment via industrial stairs, working platform, ladder, etc., as well as NFPA working clearances for all equipment electrical cabinets.

Allow service personnel access to equipment without disruption to campus activities. Provide direct access to each individual service closet and equipment room. Locate mechanical and electrical equipment rooms with access to the exterior and provide convenient service vehicle access.

Size equipment rooms to permit maintenance, repair and easy removal of equipment. Do not combine service closet and equipment room functions.

Outside on-grade access to large mechanical rooms is highly desirable. Sub-grade mechanical equipment rooms in new buildings are not allowed. Basements are not allowed.

Locate equipment so that service personnel can easily gain access. Provide permanent ladders and platforms as required.

### Standard Stock Items

Designers are directed and required to base their designs upon standard stock items whenever possible. Where custom-built items are required, the designer shall clearly state this fact.

### Hazardous Materials

Design the floor plans for the storage and arrangement of hazardous materials, chemicals, flammable liquids and gases to comply with all applicable codes. Plans require review by UNT Risk Management.

When the programming or design of a project calls for the use of caustic, hazardous, or radioactive materials, the UNT Risk Management department must provide guidance on the proper design of spaces to ensure proper fire protection, ventilation, wiring, containment, and related room components conform to the most current campus safety protocols. The department may also provide guidance on the location and adjacency requirements of hazardous material storage spaces.

### Radiation Sources

The floor plans and equipment arrangement of all radiation sources are submitted to the UNT Risk Management Office for their review and approval.

### Special Scheduling and Construction Constraints

Projects on campus require special steps to avoid or minimize interference with on-going campus operations. The UNT Project Manager shall obtain all special scheduling information and communicate it to the Design team.

## Colors for Materials and Finishes

The University encourages the use of UNT thematic colors for interior finishes and UNT branding for graphics. Refer to the UNT identity guide at <https://identityguide.unt.edu/>. The Designer should refrain from using any finish and material colors that might resemble those that are representative of other universities in the region.

## Site Design

The Designer may be asked to participate in the siting of the project. The Designer shall visit the site and evaluate proposed possible locations for the project, coordinate existing utilities, right of ways, easements, and discuss issues related to siting with the Project Manager before beginning design work. The Designer may suggest arrangements differing from those shown in the program requirements if site conditions warrant.

## Ramps and Steps

Ramps and steps shall meet accessibility requirements in all locations. Provide railings and guards at stairwells, steps, bridges, loading docks, and ramps per accessibility requirements.

Provide runways and ramps in all buildings where bulk supplies are handled. Treads and landings are to have positive drainage away from the building. Ramps should have a non-slip surface attached Appendix G, Figure 2. Carborundum or similar abrasives are not permitted (e.g., broom finish).

## Building Entry

All public entrances should be on grade, no monumental stairs, and meet accessibility requirements.

## Parking

Major lots should be paved, striped, delineated with curbs and gutters and proper illumination for safe evening use is required (see Section 26 56 00). Preserve existing trees to the greatest extent possible. Parking areas must be clearly defined and physically separated from roads. Visually separate large parking lots into smaller modules (see Appendix G, Figure 3).

For parking areas within the design scope, the Designer must provide a UNT lot designation and design for parking signs.

The Designer must provide parking for emergency and delivery vehicles, as well as University service vehicles. In the case of residence halls and similar buildings, provide for the significant loading and unloading parking demands associated with resident move-in/move-out events.

## Outdoor Spaces

Careful design of spaces in between buildings will integrate these interstitial spaces into the network of campus open spaces. Within these spaces there is the opportunity to create gathering spaces – “outdoor rooms.” Take care to locate these outdoor rooms where their activity and use will not disrupt or distract nearby classrooms or similar established activities. In developing outdoor spaces, the designer should look to the existing campus for precedents of form and material as well as lighting, signage and landscaping.

## Site Drainage

Grade the site, including paved areas, loading dock, service yards, and landscaped areas, so that gravity runoff occurs at all points. Slope all areas away from the building at a minimum gradient of 1/4 inch per foot.

Grade all terrain surrounding the building, including loading and parking areas, in such a manner as to prevent water flow into the building should storm drains serving the area become stopped up. Provide an underground storm sewer system to accommodate the roof drainage system.

Tie drainage from new construction into existing underground storm drainage systems – day-lighting of building sump pump discharge is not acceptable. Design the storm drainage system for assumed minimum rainfall intensity of two inches per hour for a five-hour storm. In addition, use 2.0 cubic feet per second per acre as the minimum runoff value in the storm drainage design.

The maximum permissible horizontal distance between a catch basin and other inlet shall not exceed 75 feet. This applies to grass areas, paved areas, elevated parking areas, etc.

## Existing Utilities

The Design team is responsible to address in their design how existing utilities within the site limits of the project will be removed, abandoned-in-place, or plugged for future use as part of the demolition plans. Dedicate a sheet in the plan set to address the unique issues for coordinating work around existing utilities.

## Interior Design

### Corridors

- Provide recesses in corridors for drinking fountains and recycling containers.
- Provide durable finish materials in recesses that will withstand repeated scrubbing.
- Provide corner guards at all outside corners in high-traffic areas.

### Space Organization

In a typical multi-floor academic building, areas with the heaviest traffic, e.g., classrooms and open computer access labs, should go on the ground floor while teaching labs would occupy intermediate floors and research labs or other light traffic spaces such as offices would occupy the top floors.

### Office Standards

UNT has functional standards for the size of newly created offices. Even though most users prefer hard-walled offices, modular wall systems provide the benefit of future flexibility to accommodate growth and change. Base modular office systems on a three-foot to four-foot module. Work surfaces should not exceed 48 inches in length. See Table 1 for recommended office sizes.

Table 1: Office Size Standards

Personnel	Office Size Designation	Modular Office Systems	Hard Wall Offices	Square Footage Range
Admin/Clerical Staff	"A"	Yes*	No	60-80
TA/TF/RA/GA	"A"	Yes	No	35-50
Faculty/Staff	"B-1" & "B-2"	Yes*	Yes	120-130
Dept. Chair or Equivalent	"C-1"	Yes*	Yes	140-150
Associate Dean or Equivalent	"C-2"	No	Yes	150-160
Dean or Equivalent	"C-3"	Yes*	Yes	170-180
Vice President or Equivalent	"D"	No	Yes	250-300

- See Appendix G, Figures 24-29 for a typical office layout corresponding to each office size.
- Where hard-wall offices are required, shelving may be either wall-hung system furniture or wooden shelving mounted on shelf standards.
- All offices should be provided with three to four duplex outlets and one voice/data outlet, or as required by code.
- Offices should be grouped together rather than dispersed in isolated groups

### Interior Wall Construction

Construct interior walls with 5/8" sheetrock and metal studs. Specifications:

- 16 – 18 gauge 3-5/8" studs on 16" on center to be used for interior structural load bearing walls, 20 - 24 gauge 3-5/8" studs on 16" on center to be used for interior non-bearing walls
- Screw spacing should a maximum of 8" staggered on joints.
- Screw spacing should a maximum of 12" in the field
- During installation of drywall, must stagger joints from one side to the other.
- Insulate with a minimum of R-13 rating or as specified by the Project Manager.
- Sheetrock to be installed vertically on metal stud framing everywhere feasible.
- All outside corners require a metal corner bead
- Where drywall meets drop ceiling or dissimilar materials "L" bead is required
- Screws (not staples or crimped) to be used to installed "L" beads and corner beads.
- Batting insulation to fill the width, depth and length of the cavity between studs with no gaps.
- When adding a wall and attaching to the drop-down ceiling grid install a j-bead to top of drywall to provide a clean and finished look.

## Classrooms

### Classrooms Systems Design

DSI-Tech will specify the components necessary to meet the current technology standards for technology in the classroom. DSI-Tech will provide a review of technology proposals, will oversee installation, and will commission the system.

- UNT (University of North Texas) Division of Digital Strategy & Innovation Technology (DSI-Tech) is responsible for designing, installing and maintaining audio/video equipment for General Use Classrooms (see Appendix D).



- The UNT Project Manager will provide the Designer with the latest DSI-Tech Classroom requirements and audio/visual equipment design criteria.
- The Designer will be responsible for collaborating with DSI-Tech for all the necessary requirements, e.g., electrical, data, structural, etc.
- All other Classroom types should comply with the same standards. Classroom access at the rear of the space is preferred.

### Classroom Lighting Control

The best lighting for a classroom will complement the needs of in-room participants, in-room presenters, connected participants and meet the needs of the installed equipment. The lighting should create an evenly lit environment that minimizes shadows and enhances room visibility. Centralized lighting control that will impact the presentation in the room (I.e., lighting control for row of lights in front of projector screen and/or projector, turn off audience lights; etc.) Exterior windows should have blinds that provide room darkening.

- Provide dual level inboard/outboard switching to control lighting in all areas, or occupancy sensors, as appropriate to the use of the space.
- Lighting control near instructor station
- Independent control/dimming at front and whole room
- Emergency always-on light should be at the rear door(s)
- The lighting near the screens should have a separate on-off switch.
- No light should fall directly on the projection screens.
- The instructor area should be well-lit with sources in front of and overhead.
- For areas over 200 square feet, provide multiple switches to reduce the lighting.
- Use dimmable LED fixtures.
- Specific whiteboard or glass board lights shall be controlled separately from the rest of the room.
- Other areas may be so equipped if feasible.
- Spaces used as classrooms part-time or full-time must meet the lighting requirements above.
- Any exceptions must be approved by UNT Project Management and DSI-TECH.

### Custodial Closets

- Provide one custodial closet for every 6,000 square feet of useable building floor space (or portion thereof) with a minimum of one custodial closet per floor. This space is for the exclusive use of custodial staff.
- Do not locate plumbing, mechanical, or electrical equipment in this room. Locate these rooms throughout the building to avoid moving equipment long distances.
- Provide for the following:

- Custodial closets shall be located on all floors throughout the building and always open to the main corridors. They should not be located in machine areas, restrooms, utility chases or utility corridors.
- Custodial closets shall be a minimum of 90 square feet and shall be equipped with a minimum of a three-foot wide door that opens outward.
- A floor-mounted porcelain service sink with hose bib, 3'0" x 3'0" with 4" to 8" sides.
- Reinforced hot and cold-water faucets located 30" above the bottom of the service sink.
- Three or more wet mop hooks or clips arranged to permit dripping of wet mops into sink basin.
- Three or more dry mop and dust mop hooks or clips on a wall opposite of the sink basin.
- A minimum of two GFI duplex electrical outlets located near the corridor door and 18" above the ground.
- A floor drain, with the entire floor sloped a minimum 1/4" per foot towards the floor drain.
- Floors shall be sealed concrete.
- No other services shall be located in the custodial closet. No electrical panels, pipe chases, entrance doors adjoining rooms, telephone switchgear, elevator panels, water heaters, or similar equipment.
- Lighting shall be 30 foot-candles flush in the ceiling.
- Provide positive ventilation, e.g., exhaust fan.
- Wall finish should be FRP, epoxy paint or other approved finish to 48" AFF and 24" past the floor sink.

## Mail Service Facilities

Department office suites usually require a series of mailboxes located in the department suite. The Designer will determine exact requirements with end users and stakeholders.

## Mechanical and Electrical Equipment Rooms

- Size mechanical and electrical equipment rooms to accommodate the building's mechanical and electrical systems and allow maintenance personnel safe access and adequate clearance.
- Locate large equipment, such as transformers, boilers, pumps, tanks, and heat exchangers, to permit easy servicing, operation, and removal.
- Provide adequate circulation areas around equipment, including valves and accessory piping.
- Mechanical rooms may be entered directly on grade from the outside or from public corridors. Steps leading to mechanical rooms are not permitted.
- All mechanical and electrical equipment rooms will have sealed concrete floors.
- In buildings with multiple mechanical/electrical equipment rooms, the rooms should be adjacent. This includes multiple story buildings.
- Stack mechanical/electrical rooms in multi-level buildings to reduce the length of piping/conductor runs.

## Public Restrooms Facilities

Public Restrooms should meet all applicable codes and accessibility standards.

- Use high durability easily cleanable materials for counter tops such as solid surface products. Note: Quartz may not be cut or otherwise disturbed once on the job site as it creates an environmental hazard that does not meet UNT's indoor air quality standards. Plastic laminate countertops are not permitted.
- Stall partitions should be floor mount head-rail braced. Material should be of high durability such as solid plastic or non-painted metal that is graffiti resistant.
- No electric hand dryers in public restrooms
- Soap dispensers will be owner furnished; Owner installed unless noted otherwise.

Stall Accessories:

- No toilet seat cover dispensers
- Provide built-in stainless steel combination paper towel/waste units such as Bobrick B-3803, B-3940, B3944 or approved equal.
- Provide stainless steel sanitary napkin disposal units in all stalls regardless of gender designation
- Ensure bathroom design allows space for owner furnished and contractor installed 9" toilet tissue dispensers
- Provide coat hook and grab bars as required

## Recycling Alcoves

Every building containing more than 10,000 square feet of useable floor space shall have a recycling alcove. This space is used exclusively for the storage of recycling equipment and material. Locate this area on the ground level, near the loading dock or service entrance. The minimum acceptable size of this area is 40 net square feet.

The Designer shall design recessed areas within mail circulation paths that will also accommodate recycling containers wherever possible.

## CONSTRUCTION

### 00 Procurement and Contracting Requirements

All contracts for UNT will follow the UNT System Uniform General Conditions for Construction and Design Contracts.

### 01 General Requirements

#### 01 14 00 Work Restrictions

##### Site Limits

The Designer establishes the limits of the construction site in coordination with the University and indicates these limits on the design development drawings. Drawings shall also specify the area used for staging and material storage during construction. If using areas of parking lots for staging, show the location of site fences and staging area. Secure the construction area with a minimum six feet (6') high chain-link type fence with top rail. The Contractor is required to remove the construction fence completely, including all portions of footings below ground level, at completion of the project. Remove fence posts -- do not saw off flush with the soil line.

##### Use of Owner's Drinking and Toilet Facilities

On major capital projects, the Contractor's personnel are not allowed to use the Owner's toilet and drinking water facilities. The Contractor shall provide temporary toilet facilities for all construction personnel. Each individual Contractor will provide drinking water facilities for their personnel.

##### Contractor's Working Hours

The Contractor may establish a work schedule of their own choosing, but the Contractor shall submit their regular daily work schedule to the Owner's Project Manager and to the Designer, and shall notify the Project Manager in advance of any deviations from this schedule. The University reserves the right to limit the Contractor's activities when they conflict with university operations.

Work is normally permitted on the days of sporting events and concerts, but traffic is extremely heavy on those days. Contractors may experience delays getting to and from the job site.

Work is normally permitted on student move-in/move-out days, but traffic is heavier than normal, parking is restricted, and some campus roads are temporarily closed or designated one-way.

##### Noise-Making Activities

In most cases, the University will require the Contractor to comply with the City of Denton Noise Ordinance; however, there are other situations where stricter noise control is required. If the project involves work in or near a building in which teaching or testing activities are being conducted, the Contractor is required to restrict operations which are disturbing to students during the hours of those activities.

### 01 14 13 Access to Site

Provide a temporary means of egress when a building addition or renovation project involves temporarily eliminating or closing an existing required means of egress. Obtain prior agreement from UNT through the Project Manager before closing any existing means of egress.

### 01 14 16 Coordination with Occupants

The Contractor and Subcontractor(s) shall instruct occupants to contact the UNT Project Manager for all questions, concerns, or coordination issues. Only the UNT Facilities Project Management team is allowed to give direction or communicate with occupants.

### 01 14 33 Work in Rights-of-Way

Contractor shall obtain permits from the municipality or agency having jurisdiction over the rights-of-way in which work will be taking place.

### 01 31 19.13 Preconstruction Meetings

The Project Manager shall arrange for a pre-construction conference. The purpose of this meeting is to review the requirements of the project and to provide a framework for the coordination of all construction activities. The Designer may be asked to participate.

### 01 32 29 Periodic Work Observation

The Designer, where required by the design contract, shall provide liaison and necessary observation of the project to ensure compliance with plans and specifications. The University's Project Manager or representative will observe work progress periodically and will provide comments to the Designer.

### 01 33 00 Submittal Procedures

The University's Project Manager will be responsible for coordinating in-house reviews of submittals, material samples, and mock-ups with the necessary individuals at the University.

### 01 35 23 Owner Safety Requirements

All projects shall comply in full with NFPA 241 Standard for Safe guarding Building Construction and Demolition Operation, 29CFR 1926 OSHA Standard for Construction including adherence to 29CFR1910, and Standard Interpretations, as necessary/applicable.

Take appropriate steps at each construction site to protect the public from hazards created by demolition and construction operations.

Separate the demolition or construction site from public access by fences, barricades or other appropriate security measures. Provide accident prevention signs and markers to warn of dangers (e.g., overhead electrical wires) and restrictions (e.g., restricted access areas, hardhat areas). Where necessary, provide protected detour routes for vehicles or pedestrian traffic.

Barricades and signs must meet OSHA, DOT, and University approval, and be substantial enough to deter bypassing, vandalizing or theft. In addition to meeting all applicable codes and regulations, keep signs neat and legible at all times. Hand-made signs are not acceptable.

All barricades, temporary walkways and protection of work and materials shall accommodate access, provide adequate warning and protection to all segments of the University population, including wheelchair users and those using walking aids and the hearing and visually impaired.

All Contractors shall comply with the OSHA Hazard Communication Standard. The written Hazard Communications Program and Material Safety Data Sheets for each hazardous chemical shall be readily available and centrally located on site.

### 01 35 46 IAQ Procedures

Contractor must coordinate with Project Manager and UNT Risk Management department to ensure scrubber capacity is appropriate to the volume of affected space and type of work.

When conducting smoke, heat or dust generating tasks, the Contractor must take steps to create or build barriers to prevent smoke, heat, or dust from getting into adjacent occupied offices, labs, classrooms and hallways, as well as taking care not to activate smoke detectors installed in buildings.

Contractor shall review with UNT Fire Systems any protection of smoke detectors planned during construction and review any required scheduled shut downs of smoke detector equipment by Facilities.

Indoor Air Quality (IAQ) Notices must be posted prior to work being performed. Coordinate all IAQ notices through the UNT Risk Management office.

### 01 35 53 Security Procedures

The University only provides security measures deemed prudent for its own operations. The Contractor shall provide the necessary security to protect their work, materials, tools, and construction equipment from vandalism, theft and fire. The Contractor shall supply watchmen services as deemed necessary.

Contractor shall review with UNT the security measures for the construction site and submit the name of outside security contractor for approval by the Owner. The Contractor is responsible for replacement of their materials, machinery, equipment, tools and supplies which are the subject of theft. Clearly mark all tools and equipment with the Contractor's identification. The Contractor shall clearly mark all tool boxes.

Contractor shall provide the Owner with a list of day and night phone numbers to use in case of emergencies during the course of the project.

### 01 41 13 Codes

Refer to the UNT System Authority Having Jurisdiction for the latest edition of applicable building codes and standards for UNT System and campuses.

All applicable codes must be listed on the cover sheet of construction documents.

The following standards apply to all projects managed by UNT System, UNT and Non-UNT Contractors on the UNT campus:

- UNT Campus Master Plan (Latest Edition)
- UNT Design & Construction Standards (Latest Edition)
- UNT Tree Preservation Policy
- UNT practice for LEED Silver minimum
- UNT Campus Parking & Transportation Master Plan
- UNT & UNT System Policies as applicable
- Applicable Building Codes as amended by variance by UNTS Authority Having Jurisdiction (AHJ)
- Applicable municipal requirements

## 01 41 16 Laws

### Accessibility

The University is committed to making all buildings and areas of the campus physically accessible to all students, faculty and staff. Therefore, Designers are required to accommodate the special requirements of all segments of the University population – including wheelchair users, those who use walking aids and the hearing and visually impaired – in their design. All new construction shall fully comply with accessibility requirements.

### Energy Conservation

Energy conservation is an essential factor in the design and development for all new construction and renovation projects. For all new construction and major renovation projects, an effort will be made to exceed ASHRAE/IES 90.1, latest edition, “Energy Code for Commercial and High-Rise Residential Buildings” by 15% for the design and specification of materials and equipment.

Energy efficiency is a shared responsibility between all design professionals and should be an agenda item at all collaborative design meetings. The efficiency measures must take into consideration the entire life of the building. Ideas should not be limited to equipment efficiencies but can include building orientation, architectural layout, site planning, sequence of operations and building schedules. Life cycle cost analysis is recommended for major design or renovation projects.

Texas Law now requires that all new construction or major renovation undertaken by state agencies and state-supported institutions of higher education comply with the Texas State Energy Conservation Design Standards. The State Energy Conservation Office (SECO) through administrative rule adopted these standards effective September 1, 2011. Refer to the statute and rule:

Statutory Reference: Texas Government Code, 447.004

<https://statutes.capitol.texas.gov/Docs/GV/htm/GV.447.htm>

Key points from 447.004 all designers and contractors shall comply with:

- Rule Cite: Texas Administrative Code Title 34, Part 1, Chapter 19, Subchapter C
- Rule Cite: Texas Administrative Code Title 34, Part 1, Chapter 19, Subchapter E

SECO Certification: before beginning construction of a new state building or a major renovation project, a state agency or an institution of higher education shall submit to the State Energy Conservation Office (SECO) a copy of the certification by the design architect or engineer that verifies project complies with the energy standards, including engineering documentation. This certification form can be found on the SECO website: <http://www.seco.cpa.state.tx.us/>. Routine maintenance and operational change out of

material and equipment, where no engineering or architectural design assignment is necessary, are exempt from the submission of the compliance certification.

### Excavation

Contractors must comply with statutory requirements for excavation work.

- Rule Cite: Texas Administrative Code, Title 16, Part 1, Chapter 18 Underground Pipeline Damage Prevention

### 01 41 26 Permits

The Contractor is responsible for obtaining all permits required for the installation of their work. The Contractor is responsible for fees as outlined in the Specification. The Contractor shall determine the amounts prior to bidding and shall include these amount(s) in the bid. Building permits and inspections by the local municipality are not applicable within UNT's jurisdiction except within municipal right-of-way or easement (such as roadways and utilities).

Contractor must have a Work Permit approved by UNT Risk Management to proceed with any of the following:

- Confined Space Entry
- Hot Work
- Elevated Work

Refer to the Risk Management website for appropriate forms and definitions:

[https://riskmanagement.unt.edu/environmental-risk/occupational\\_safety.html](https://riskmanagement.unt.edu/environmental-risk/occupational_safety.html)

### 01 43 36 Field Samples

#### Selection of Brick or Cast Panel for Exterior Walls

The manufacturers shall present samples to the Designer for his selection from which sample patterns are to be erected or shown on the job site. Coordinate with the Construction Manager as to the location of these panels. UNT will notify the Designer of the final selection. In the case of cast stone panels, small samples may be submitted for selection purposes.

Completed panels must cure for at least three weeks before they are reviewed by the Owner. In addition, three weeks are required to schedule this review. Therefore, the panels must be completed by the Contractor a minimum of six weeks before the brick selection is needed.

### 01 45 23 Testing and Inspecting

The Contractors shall give reasonable notice of construction activities requiring testing and inspection to allow scheduling through the UNT Construction Project Manager.

The University will also arrange for independent testing agencies to perform special testing and inspections of work in progress. Again, the Contractors shall give reasonable notice of such construction activities requiring special testing and inspection to allow scheduling with the testing agency.

In addition to the special inspections, the Construction Manager will schedule all other testing and inspections as per the contract, including but not limited to above ceiling inspections, pre-final



inspections, fire detection and alarm system testing. Do not cover any items without the approval of the Construction Manager, i.e., underground, formwork, walls, ceiling, etc. Any of these inspections which are not completed satisfactorily are repeated at no cost to the owner and without time extension. All inspections and testing for the fire protection systems and life safety are performed by UNT Fire Systems staff and the fire protection contractor.

### 01 55 00 Vehicular Access and Parking

Parking is extremely limited at the University. Parking lots and the streets in the immediate vicinity of the University are permit only parking. The Project Manager will provide at no cost a reasonable number of parking permits for the Contractor to distribute to workers for their personal vehicles. Reference parking permit types below. The Contractor is expected to regain the permits and redistribute them to new subcontractors as the project progresses. Vehicles parked in areas other than the designated areas within the University controlled area may receive citations. Citations will not be excused. Vehicles receiving citations which are not paid may be impounded.

Contractors have two options when parking on campus for construction projects:

- Permits issued by Facilities or campus personnel. Contractors may park in lots 13 and 35 and be driven over to their work site by a colleague. During evenings and weekends, these passes may be used for parking on interior FS or Eagle lots.
- Business/vendor Permit (BV). Annual permits that can be purchased at anytime during the year. Contractor must have a Facilities representative email the UNT Parking and Transportation Office to confirm that this particular vendor is frequently on campus. Valid in FS and Eagle lots and for two hours in Visitor lots.

All contractors are responsible for informing their employees that they cannot park at any locations on the campus other than the designated or allocated spaces. All existing University parking regulations are enforced.

Park large storage trailers inside the job site only. If additional trailer parking is required, contact the Project Manager to coordinate an approved location.

### 01 56 00 Temporary Barriers and Enclosures

Enclose the construction area with a six-foot (6') high (minimum) chain link type fence with top rail. At the completion of the project the Contractor shall remove the construction fence completely including below ground level. Fence posts shall not be sawed off flush with the soil line.

Temporary interior construction walls/barriers shall be fire-rated. When plastic sheeting is used, approved manufacturer is Americovering, FR4-Mill Black Polyethylene protective plastic sheeting. Other construction materials must be submitted and reviewed for approval by UNT Fire Marshal.

### 01 56 39 Temporary Tree and Plant Protection

Give special attention to any trees, shrubs or lawn remaining inside the construction area. To protect such materials, install a landscape protection fence prior to the initial stage of grading, excavation or tree removal. This fence or barricade must be a minimum of 3 feet high and is required to remain in

place for as long as is practical. The landscape protection area shall extend to at least the drip line of any trees or shrubs that are to remain.

No storage, access or activity of any kind is permitted in the landscape protection areas. This specifically includes the felling of trees into the landscape protection areas. No limbs, tops, stumps, fill, material storage or equipment is permitted in the landscape protection areas at any time.

Take care to protect trees and shrubs from damage by cranes, falling objects, etc. The Contractor shall not move or prune trees and shrubs. When pruning or moving is necessary, notify the Designer and the Owner shall in turn perform the work at no cost to the Contractor.

Protect plants and trees outside the construction limits from:

- Compaction of root areas by equipment, materials, or fill dirt.
- Trunk damage by moving equipment, material storage, mauling or bolting.
- Poisoning by pouring solvents, gas, paint, etc. on or around roots.
- Damage of branches by improper equipment activity.
- Cutting of roots within the drip line of the tree.

It is specifically prohibited to fell or bulldoze trees into a wooded area that is adjacent to the site being cleared for construction. Site clearing should be done so as to prevent damage to wooded areas adjacent to the project.

Do not use trees as props or anchors for materials, guy wires, cables or utility wires.

A tree surgeon or nurseryman shall repair or replace damaged trees, shrubs or lawns in a manner acceptable to the University with the cost of the repairs or replacements paid by the Contractor. Maintain landscape with proper fertilization and irrigation during construction.

Contractor will provide a specific "chemical or caustic" material mixing/staging area. This area is to be self-contained and will not allow spread to any soil.

### 01 57 13 Temporary Erosion and Sediment Control

The Designer's Erosion and Sediment Control Plan for the project shall follow UNT's storm water pollution prevention plan (SWPPP), available from Owner upon request. The plan shall clearly delineate between which measures are temporary and which are permanent. The Contractor must comply with the UNT Stormwater Management and Protection Plan.

Contractor to submit the following information to the City of Denton via email to [watershed@cityofdenton.com](mailto:watershed@cityofdenton.com), [joetta.dailey@cityofdenton.com](mailto:joetta.dailey@cityofdenton.com), and [Zachary.peterson@cityofdenton.com](mailto:Zachary.peterson@cityofdenton.com):

1. The name, phone number, and email address for both the UNT Project Manager and the Contractor's Project Manager.
2. A description of the location of the project.
3. Anticipated start date of construction activity.
4. A copy of the erosion control plan for the site.

The Contractor must obtain appropriate storm water permits and provide appropriate measures, such as block, gravel filters or silt fences, during construction as required to protect catch basins, storm drains and streams from the entry of all silt and construction debris.

Contain the residue from the cleaning of ready-mix trucks, wheelbarrows, concrete buddies, etc. and remove from the campus with other refuse.

No dumping of debris into drains or catch basins is permitted. Contractor is responsible for cleaning or replacing drain lines if a violation occurs.

The Contractor is required to remove all temporary erosion control measures including silt fencing, inlet protection measures and sediment traps after the site is stabilized and prior to final inspection.

### 01 58 00 Project Identification

The Contractor provides a sign identifying a construction project and the principal parties participating in the project. Only one identification sign is allowed per project. No additional signs identifying participants is allowed.

UNT must approve the design of the project identification sign. The sign shall give the name of the University, the title of the project, and, in smaller lettering, the names of the Designer and Contractor(s).

Provide warning and safety signs as required. Keep all other informational signage to a minimum.

All signs shall be kept clean and free of graffiti and maintained by the Contractor.

### 01 71 23 Field Engineering

As part of project site preparation, the Contractor will install in the ground geodetic benchmark caps set in concrete to be used as dimensional control, as opposed to iron rods, concrete x-cuts or other benchmark objects. Contractor must use a cap with a minimum 2" diameter and a 1.75" stem. Material may be aluminum or brass. The cap must be stamped with "University of North Texas" on the outer ring, "Secondary Point" on the inner ring, a point mark in the center, and a benchmark number below the point. Coordinate the benchmark number with UNT Facilities Geographic Information Systems (GIS) to obtain available benchmark numbers for the project.

Once set, a licensed surveyor must occupy these points and provide the metadata to the Contractor for use in the project. The coordinate system must comply with the UNT Coordinate System, available upon request from UNT Facilities GIS. Both surface and grid values of horizontal and vertical positions must be provided, including the scale factor for conversion between the two values.

### 01 74 00 Cleaning and Waste Management

Keep the construction site, and adjacent campus areas, free of trash, litter or debris at all times. Empty waste containers at the frequency required to keep the contents overflowing. The Contractor shall remove litter, rubbish and debris from the job site on a daily basis.

Use of University trash receptacles for construction waste is not allowed. The outdoor burning of trash debris on campus is not allowed.

Non-UNT waste containers must be registered with UNT Facilities. The UNT Project Manager will provide the UNT project number, company name, company contact information, and container number(s) or identifier(s) to the UNT Facilities Utilities Coordinator.

The Contractor is fully responsible for the containment of mud and debris on the site as well as removal of these items from roads and walkways.

The Contractor shall trim/mow grass, irrigate grass and other vegetation on the construction site as often as required to maintain a neat appearance.

Do not allow debris to accumulate in corridors or stairways. As construction is completed, protect the work to prevent soiling or spotting, particularly with regard to flooring systems. The carpet shall be cleaned and kept free of spots or traffic patterns. Resilient floors shall be cleaned, sealed and properly finished to provide a uniform appearance without streaks or smears.

### 01 77 00 Closeout Procedures

Designer and Contractor shall comply with Articles 9 and 15 of the UNT System Uniform General Conditions for Construction and Design Contracts regarding close-out requirements and procedures.

### 01 77 19 Closeout Requirements

Designer and Contractor shall comply with Articles 9 and 15 of the UNT System Uniform General Conditions for Construction and Design Contracts regarding close-out requirements and procedures.

### 01 78 23 Operation and Maintenance Data

Contractor is required to provide all product brochures, instructional manuals, operating and maintenance manuals, warranties, and training documentation as part of project close-out.

### 01 78 29 Final Site Survey

The Contractor shall employ a registered professional land surveyor licensed to work in the state of Texas in order to perform a land survey of the final site conditions.

Comply with Appendix K Guidelines for Land Survey Work.

### 01 78 39 Project Record Documents

Comply with Appendix H Specifications for Construction Project Electronic Deliverables.

### 01 78 46 Extra Stock Materials

UNT has limited storage space so attic stock shall be limited to certain items only. All new buildings are required to provide a storage room specifically for permanent storage of attic stock materials. Coordinate all attic stock requirements with the UNT Project Manager, and please reference Appendix J for attic stock requirements.

For new buildings, construct a secured storage area within the building as part of the building program. A full complement of attic stock materials should be provided by the Contractor at close-out.

For building renovations, due to a lack of available storage, attic stock items are to be identified early on in the design phase to determine critical needs. Generally, these will be items to support equipment rooms and will not include architectural materials unless specialty non-university standard finishes are specified. The attached check list should be filled out by Facilities identifying these items.

In no case will remnant construction materials (such as small pieces or opened packages) be retained as attic stock.

Contractor shall provide UNT Facilities with a written list including amounts as part of the close-out document package.

All attic stock items should be clearly labeled with the date, construction project and stock information.

*Table 2: Attic Stock Checklist*

<b>"X" indicates to be included in contract</b>	<b>Specification Section</b>	<b>Material</b>	<b>Provided Attic Stock</b>
	087100	Door Hardware	Special Tools Maintenance Tools
	093000	Tiling	Tile and Trim Units - 3% of installed Grout - 3% of installed
	095113	Acoustical Panel Ceilings	Ceiling Tile, Grid, and Clips: 2% of installed
	095133	Acoustical Metal Pan Ceilings	Ceiling Tile, Grid, and Clips: 2% of installed
	096513	Resilient Base and Accessories	Wall Base: 10 ft. for every 500 ft. of Each Type, Color, Pattern and Size Used
	096519	Resilient Tile Flooring	Floor Tile: 1 box for every 50 boxes of Each Type, Color, and Pattern Used
	096813	Tile Carpeting	Carpet Tile: 5% of Each Type Used, Not Less Than 10 sq. yd.
	096816	Sheet Carpeting	Carpet Rolls: 5% of installed

	097713	Panel Fabric Wall and Ceiling Systems	5% of Gross Wall and Ceiling Area of Each Color Pattern and Type Used
	099113	Exterior Painting	Paint: 5% of Applied, Not Less than (1) Gallon
	099123	Interior Painting	Paint: 5% of Applied, Not Less than (1) Gallon
	099646	Intumescent Painting	Paint: 5% of Applied, Not Less than (1) Gallon
	102226	Operable Partitions	Panel Finish Material: Two sides of Two Panels
	122413	Roller Window Shades	Roller Shades: 5% of Installed, but No Fewer Than 2 Units, for Each Size, Color, and Shadeband
	211313	Wet-Pipe Sprinkler Systems	Spare Heads and Wrenches in Cabinets
	224700	Drinking Fountains & Water Coolers	Filter Cartridges: 10% of Installed, not <1 Each Type
	232123	Hydronic Pumps	Seals: (1) for Each Pump
	233300	Air Duct Accessories	Fusible Links: 10% of Installed
	233416	Centrifugal HVAC Fans	Belts: 1 Set for Each Belt-Driven Unit
	233423	HVAC Power Ventilators	Belts: 1 Set for Each Belt-Driven Unit Motor Puller for Fans >5 HP
	233600	Air Terminal Units	Pan-Powered-Unit Filters: (1) Spare Filter for Each Filter Installed
	234100	Particulate Air Filtration	Filters: (2) Sets for Each Filter Bank
	237313	Modular Indoor Central-Station Air-Handling Units	Filters: (2) Sets for Each AHU Belts: (1) Set for Each AHU Fan
	238126		

		Split-System Air-Conditioners	Filters: (1) Set / Unit Fan Belts: (1) Set / Unit
	238219	Fan Coil Units	Filters: (2) Spare for Each Installed Belts: (2) Spare for Each Installed
	261300	Medium-Voltage Switchgear	Touch-Up Paint Can: Munsell Green 9999-058
	271500	Communications Horizontal Cabling	Patch-Panel Units, Connecting Blocks Device Plates Multiuser Telecom Outlets: (1) Each Type
	283111	Digital, Addressable Fire-Alarm System	Lamps, Smoke Detectors, Fire Detectors, Detector Bases, Keys and Tools, Notification Appliances, Fuses
	321413.19	Permeable Interlocking Concrete Pavement	(1) Palette of Each Color and Type Used
	328400	Planting Irrigation	(5) Parts Each of Irrigation Components

01 78 53 Sustainable Design Closeout Documentation

Contractors are required to provide MSDS sheets for all materials used on a job as part of the submittal deliverable.

Contractors shall submit a signed and notarized letter confirming all materials used in constructing the project are free of asbestos.

Contractor shall provide all documentation for any systems and equipment that are designed and built to either LEED certification, Well Building or other sustainable building standards.

01 79 00 Demonstration and Training

Unless otherwise agreed upon, all demonstrations and training shall occur during normal business hours, Monday through Friday, when UNT is open. The UNT Project Manager will coordinate scheduling between pertinent UNT staff and the Contractor.

At a minimum, the Contractor shall provide demonstration and training for the following building systems, plus any additional as deemed necessary for the project:

1. Fire Alarm and Sprinkler
2. Mechanical
3. Building Automation and Controls
4. Electrical
5. Plumbing
6. Security

7. Lighting and Controls
8. Audio/Visual

## 01 81 13 Sustainable Design Requirements

### Materials Conservation

The University is dedicated to the principle of conserving materials and energy. The Designer should scrutinize proposed construction for means of reducing the initial cost of non-renewable resources, energy used and long-range reduction of operating costs by the new assets. In addition to basic conservation requirements, the Designer should consider advanced design technologies including: renewable energy sources, recycled materials content and non-conventional materials without compromising the practical maintenance and operations requirements of the facility. The Designer should take into account the climate of the facility and make sure the design reflects that consideration (e.g., windows may be recessed for shading). Contractors are required to give alternate pricing for salvaging scrap material to the maximum extent practical, especially scrap metals and lumber. In the product specifications, encourage vendors to offer products having recycled content.

All materials used for construction must not contain asbestos.

## 02 Existing Conditions

### 02 01 00 Maintenance of Existing Conditions

#### Protection of Campus Buildings, Streets and Sidewalks

The Contractor is responsible for protection of existing buildings, roofs, trees, shrubbery, and lawn areas from damage by vehicles, equipment, overhead cranes, falling objects, etc.

The Contractor is responsible for protecting the campus streets and walks connecting to the project from deposits of mud, sand, stone, litter or debris in any form. Clean off all mud collected on vehicle wheels before leaving the construction area. Should any mud or debris collect on the streets from the construction project, remove immediately.

Where vehicles and equipment must cross lawns, landscaping, sidewalks, buried utilities, etc., the Contractor shall provide minimum 3/4" thick plywood, track mats, or other methods as approved by UNT Project Manager to ensure protection and avoid any damage.

#### Protection of Underground Utility Lines

Each contractor or subcontractor who performs excavation work must provide the UNT Project Manager with need to dig notice 73 hours in advance of work being performed. The contractor must mark the area or route of the dig location with white spray paint and/or white flags.

The Contractor is responsible for entering Texas811 tickets and complying with call-before-you-dig procedures.

The Contractor is responsible for the consequences of any utility interruption caused by his or her excavation, and is responsible for the cost of repairing any damage done to the utilities themselves.



### Protection of Existing Trees

The following provisions apply to existing trees adjacent to the line of work which are to remain on site through construction and after the project is finished.

1. Tree protection will be constructed using metal posts and chain link fence. Fence shall be a minimum of 3' outside of the drip line of the tree. Fence will be maintained and not taken down for any reason without approval from UNT Grounds Manager or UNT System Landscape Architect. Install and maintain a minimum of 3" composted material comprised of shredded hardwood mulch. City of Denton, Jemasco and Living Earth are examples of materials available for use.
2. Water trees during construction to maintain moisture levels enjoyed by the tree prior to construction.
3. Any roots broken and disturbed during construction operations shall be immediately cleanly cut back to solid wood and sprayed with root sealant. Do not leave uncut, frayed roots without immediate treatment and UNT is to inspect any trench before filling occurs.
4. Do not mechanically trench under trees. Trench using Air Spade Technology offered by Root Flare Services, Dallas, TX, or bore underneath.
5. Do not pile any soil, equipment or materials under drip lines of trees - maintain original soil level for any tree remaining on site during construction.
6. Contractor shall prune low hanging limbs to provide ground clearance and avoid being broken off by heavy equipment. Tree work to be done by an established, experienced tree care company to proper arbor logical standards. All cuts to be slightly outside the collar of the limb, 1/8-1/4 inch, cuts over 3/4" to be painted with a tree pruning paint, cut limbs to be removed from site. Pruning for ground clearance shall be completed prior to demolition/construction.
7. When the proximity of the project to an existing tree does not require work to be done within the tree's drip line or CRZ-Critical Root Zone, the Contractor shall take all necessary precautions to protect this area from equipment damage. The area within the CRZ shall not be used for storage of any material, trash or rubbish, dumping nor travel or parking of any equipment. Any trash or other materials found within the drip line shall be removed on the same day as it is found. If in the opinion of the Owner, the Contractor has not taken the necessary precautions to protect the area within the drip line, a chain link fence shall be constructed around the tree under the drip line at the direction of the Owner. Any damage caused by such materials, its placement or removal shall be repaired, or if repairable and a major hazard to the tree's health, Owner may order that the tree be removed and replaced with a comparable tree all at Contractor's expense.
8. Any damage caused to an existing tree's canopy, limbs, trunk(s) or root system shall be repaired at Contractor's expense and such repairs included in the one-year guarantee of the project.

### 02 22 00 Existing Conditions Assessment

The University shall furnish any existing record documentation for the project including record drawings for remodeling projects. The University cannot warrant that this information is correct. The Designer shall supplement this information with their own field investigation and due diligence. The Designer is responsible for reporting to the owner any inaccuracy in the information provided.

### 02 21 00 Surveys

Comply with the, Appendix K UNT Guidelines for Land Survey and Civil Work.

### 02 41 00 Demolition

Contractor is responsible for ensuring all site utilities abandoned-in-place or capped for future use are properly sealed, and recorded on the construction document plans where the lines run and where they terminate.

Ensure that for renovation projects in existing buildings demolition scope includes removal of all abandoned wiring in ceiling cavities including control wiring, IT communications wiring, any electrical within the building as part of the project unless an exception is approved by owner

## 03 Concrete

### 03 30 00 Cast-in-Place Concrete

This Section specifies cast-in place concrete, including formwork, reinforcement, concrete materials, mixture design, placement procedures, and finishes.

#### **Part 1 General**

##### 1.1 SUBMITTALS

- A. Product Data: For each type of product indicated.
- B. Design Mixtures: For each concrete mixture.
- C. Shop Drawings: For steel reinforcement and formwork as needed or indicated.
- D. Material test reports as required per specifications.

##### 1.2 REFERENCES

- A. ACI 301 – Specifications for Structural Concrete for Buildings.
- B. ACI 302 – Guide for Concrete Floor and Slab Construction.
- C. ACI 304 – Recommended Practice for Measuring, Mixing, Transporting and Placing Concrete.
- D. ACI 318 – Building Code Requirements for Reinforced Concrete.
- E. ACI 212 – Admixtures for Concrete.
- F. CRSI – Manual of Standard Practice for Fabricating, Placing, and Supporting reinforcement.

##### 1.3 QUALITY ASSURANCE

- A. Manufacturer Qualifications: A firm experienced in manufacturing ready-mixed concrete products and that complies with ASTM C 94/C 94M requirements for production facilities and equipment.
- B. ACI Publications: Comply with the following unless modified by requirements in the Contract Documents:
  - 1. ACI 301, "Specification for Structural Concrete,"
  - 2. ACI 117, "Specifications for Tolerances for Concrete Construction and Materials."
- C. Pre-Installation Conference: Conduct conference at Project site if required by engineer.

#### **Part 2 Products**

##### 2.1 FORM-FACING MATERIALS

- A. Smooth-Formed Finished Concrete: Form-facing panels that will provide continuous, true, and smooth concrete surfaces. Furnish in largest sizes practical to minimize number of joints.
- B. Rough-Formed Finished Concrete: Plywood, lumber, metal, or another approved material. Provide lumber dressed on at least two edges and one side for tight fit.

##### 2.2 STEEL REINFORCEMENT

- A. Reinforcing Bars: ASTM A 615/A 615M, Grade 60, deformed. #5 Rebar 12" on center is required for any drivable concrete surface (Width Greater than 5')
- B. Bar Supports: Bolsters, chairs, spacers, and other devices for spacing, supporting, and fastening reinforcing bars in place. Manufacture bar supports from steel wire, plastic, or precast concrete according to CRSI's "Manual of Standard Practice."
- C. Wire Mesh is not acceptable

### 2.3 CONCRETE MATERIALS

- A. Cementitious Material: Use the following cementitious materials, of the same type, brand, and source, throughout Project:
  - 1. Portland Cement: ASTM C 150, Type I/II.
    - a. Fly Ash: ASTM C 618, Class C, F.
- B. Normal-Weight Aggregates: ASTM C 33, graded, 1-1/2-inch nominal maximum coarse-aggregate size.
  - 1. Fine Aggregate: Free of materials with deleterious reactivity to alkali in cement.
- C. Water: ASTM C 94/C 94M and potable.
- D. Air-Entraining Admixture: ASTM C 260 as defined for exterior applications.
- E. Chemical Admixtures: Provide admixtures certified by manufacturer to be compatible with other admixtures and that will not contribute water-soluble chloride ions exceeding those permitted in hardened concrete. Do not use calcium chloride or admixtures containing calcium chloride.
  - 1. Water-Reducing Admixture: ASTM C 494/C 494M, Type A when specified or required.
  - 2. Retarding Admixture: ASTM C 494/C 494M, Type B when specified or required.
  - 3. Water-Reducing and Retarding Admixture: ASTM C 494/C 494M, Type D when specified or required.
  - 4. High-Range, Water-Reducing Admixture: ASTM C 494/C 494M, Type F when specified or required.
  - 5. High-Range, Water-Reducing and Retarding Admixture: ASTM C 494/C 494M, Type G when specified or required.
  - 6. Plasticizing and Retarding Admixture: ASTM C 1017/C 1017M, Type II when specified or required.

### 2.4 VAPOR RETARDERS- When specified or required

- A. Plastic Vapor Retarder: ASTM E 1745, Class A. Include manufacturer's recommended adhesive or pressure-sensitive tape.

### 2.5 CURING MATERIALS- When specified or required

- A. Absorptive Cover: AASHTO M 182, Class 2, burlap cloth made from jute or kenaf, weighing approximately 9 oz./sq. yd. when dry when specified or required.
- B. Moisture-Retaining Cover: ASTM C 171, polyethylene film or white burlap-polyethylene sheet.
- C. Water: Potable.
- D. Clear, Waterborne, Membrane-Forming Curing Compound: ASTM C 309, Type 1, Class B, dissipating.
- E. Clear, Waterborne, Membrane-Forming Curing and Sealing Compound: ASTM C 1315, Type 1, Class A.

### 2.6 CONCRETE MIXTURES- When specified or required

- A. Prepare design mixtures for each type and strength of concrete, proportioned on the basis of laboratory trial mixture or field test data, or both, according to ACI 301.
- B. Proportion normal-weight concrete mixture as follows:
  - 1. Minimum Compressive Strength at 28th day: Reference Structural Notes.
  - 2. Maximum Water-Cementitious Materials Ratio: Reference Structural Notes.
  - 3. Slump Limit: Reference Structural Notes.
  - 4. Air Content: 5 percent, plus or minus 1.5 percent at point of delivery for 1-1/2-inch nominal maximum aggregate size.
  - 5. Air Content: Do not allow air content of troweled finished floors to exceed 3 percent.

## 2.7 FABRICATING REINFORCEMENT

- A. Fabricate steel reinforcement according to CRSI's "Manual of Standard Practice."

## 2.8 CONCRETE MIXING

- A. Ready-Mixed Concrete: Measure, batch, mix, and deliver concrete according to ASTM C 94/C 94M and furnish batch ticket information.
  - 1. When air temperature is between 85 and 90 deg F, reduce mixing and delivery time from 1-1/2 hours to 75 minutes; when air temperature is above 90 deg F, reduce mixing and delivery time to 60 minutes.

## Part 3 Execution

### 3.1 FORMWORK

- A. Design, erect, shore, brace, and maintain formwork according to ACI 301 to support vertical, lateral, static, and dynamic loads, and construction loads that might be applied, until structure can support such loads.
- B. Construct formwork so concrete members and structures are of size, shape, alignment, elevation, and position indicated, within tolerance limits of ACI 117.
- C. Chamfer exterior corners and edges of permanently exposed concrete when specified.

### 3.2 EMBEDDED ITEMS

- A. Place and secure anchorage devices and other embedded items required for adjoining work that is attached to or supported by cast-in-place concrete. Use setting drawings, templates, diagrams, instructions, and directions furnished with items to be embedded.

### 3.3 STEEL REINFORCEMENT

- A. General: Comply with CRSI's "Manual of Standard Practice" for placing reinforcement.

### 3.4 JOINTS

- A. General: Construct joints true to line with faces perpendicular to surface plane of concrete.
- B. Construction Joints: Install so strength and appearance of concrete are not impaired, at locations indicated or as approved by Architect or UNT Project Manager.

### 3.5 CONCRETE PLACEMENT

- A. Before placing concrete, verify that installation of formwork, reinforcement, and embedded items is complete and that required inspections have been performed.
- B. Deposit concrete continuously in one layer or in horizontal layers of such thickness that no new concrete will be placed on concrete that has hardened enough to cause seams or planes of weakness. If a section cannot be placed continuously, provide construction joints as indicated. Deposit concrete to avoid segregation.
  - 1. Consolidate placed concrete with mechanical vibrating equipment according to ACI 301.
- C. Cold-Weather Placement: Comply with ACI 306.1.
- D. Hot-Weather Placement: Comply with ACI 301.

### 3.6 FINISHING FORMED SURFACES

- A. Rough-Formed Finish: As-cast concrete texture imparted by form-facing material with tie holes and defects repaired and patched. Remove fins and other projections that exceed specified limits on formed-surface irregularities.
  - 1. Apply to concrete surfaces not exposed to public view.
- B. Smooth-Formed Finish: As-cast concrete texture imparted by form-facing material, arranged in an orderly and symmetrical manner with a minimum of seams. Repair and patch tie holes and defects. Remove fins and other projections that exceed specified limits on formed-surface irregularities.
  - 1. Apply to concrete surfaces exposed to public view, to receive a rubbed finish, and to be covered with a coating or covering material applied directly to concrete.

- C. Rubbed Finish: Apply the following to smooth-formed finished as-cast concrete where indicated:
  - 1. Smooth-Rubbed Finish: Not later than one day after form removal, moisten concrete surfaces and rub with carborundum brick or another abrasive until producing a uniform color and texture. Do not apply cement grout other than that created by the rubbing process.
  - 2. Grout-Cleaned Finish: Wet concrete surfaces and apply grout of a consistency of thick paint to coat surfaces and fill small holes. Mix one part Portland cement to one and one-half parts fine sand with a 1:1 mixture of bonding admixture and water. Add white Portland cement in amounts determined by trial patches so color of dry grout will match adjacent surfaces. Scrub grout into voids and remove excess grout. When grout whitens, rub surface with clean burlap and keep surface damp by fog spray for at least 36 hours.
  - 3. Cork-Floated Finish: Wet concrete surfaces and apply a stiff grout. Mix one part Portland cement and one-part fine sand with a 1:1 mixture of bonding agent and water. Add white Portland cement in amounts determined by trial patches so color of dry grout will match adjacent surfaces. Compress grout into voids by grinding surface. In a swirling motion, finish surface with a cork float.
- D. Related Unformed Surfaces: At tops of walls, horizontal offsets, and similar unformed surfaces adjacent to formed surfaces, strike off smooth and finish with a texture matching adjacent formed surfaces. Continue final surface treatment of formed surfaces uniformly across adjacent unformed surfaces, unless otherwise indicated.

### 3.7 FINISHING FLOORS AND SLABS

- A. General: Comply with ACI 302.1R recommendations for screeding, re-straightening, and finishing operations for concrete surfaces. Do not wet concrete surfaces.
- B. Scratch Finish: While still plastic, texture concrete surface that has been screeded and bull-floated or darbied. Use stiff brushes, brooms, or rakes to produce a profile amplitude of 1/4 inch in 1 direction.
  - 1. Apply scratch finish to surfaces indicated and to receive concrete floor toppings and to receive mortar setting beds for bonded cementitious floor finishes.
- C. Float Finish: Consolidate surface with power-driven floats or by hand floating if area is small or inaccessible to power driven floats. Re-straighten, cut down high spots, and fill low spots. Repeat float passes and re-straightening until surface is left with a uniform, smooth, granular texture.
  - 1. Apply float finish to surfaces indicated, to receive trowel finish, and to be covered with fluid-applied or sheet waterproofing, built-up or membrane roofing, or sand-bed terrazzo.
- D. Trowel Finish: After applying float finish, apply first troweling and consolidate concrete by hand or power-driven trowel. Continue troweling passes and re-straighten until surface is free of trowel marks and uniform in texture and appearance. Grind smooth any surface defects that would telegraph through applied coatings or floor coverings.
  - 1. Apply a trowel finish to surfaces indicated, exposed to view or to be covered with resilient flooring, carpet, ceramic or quarry tile set over a cleavage membrane, paint, or another thin-film-finish coating system.
  - 2. Finish and measure surface so gap at any point between concrete surface and an unlevelled, freestanding, 10-foot- long straightedge resting on 2 high spots and placed anywhere on the surface does not exceed 1/8 inch.

- E. Trowel and Fine-Broom Finish: Apply a first trowel finish to surfaces indicated, where ceramic or quarry tile is to be installed by either thickset or thin-set method. While concrete is still plastic, slightly scarify surface with a fine broom.
  - 1. Comply with flatness and levelness tolerances for trowel finished floor surfaces.
- F. Broom Finish: Apply a broom finish to exterior concrete platforms, steps, and ramps, and elsewhere as indicated.

### 3.8 CONCRETE PROTECTING AND CURING

- A. It is solely the responsibility of the Contractor to protect any poured concrete from damage due to graffiti, premature use or protection from weather until fully cured and considered ready for use. Replacement costs of material and labor of any damaged concrete surfaces is the responsibility of the Contractor.
- B. General: Protect freshly placed concrete from premature drying and excessive cold or hot temperatures. Comply with ACI 306.1 for cold-weather protection and ACI 301 for hot-weather protection during curing.
- C. Evaporation Retarder: Apply evaporation retarder to unformed concrete surfaces if hot, dry, or windy conditions cause moisture loss approaching 0.2 lb./sq. ft. x h before and during finishing operations. Apply according to manufacturer's written instructions after placing, screeding, and bull floating or darbying concrete, but before float finishing.
- D. Cure concrete according to ACI 308.1, by one or a combination of the following methods:
  - 1. Moisture Curing: Keep surfaces continuously moist for not less than seven days.
  - 2. Moisture-Retaining-Cover Curing: Cover concrete surfaces with moisture-retaining cover for curing concrete, placed in widest practicable width, with sides and ends lapped at least 12 inches, and sealed by waterproof tape or adhesive. Cure for not less than seven days. Immediately repair any holes or tears during curing period using cover material and waterproof tape.
  - 3. Curing Compound: Apply uniformly in continuous operation by power spray or roller according to manufacturer's written instructions. Recoat areas subjected to heavy rainfall within three hours after initial application. Maintain continuity of coating and repair damage during curing period.
    - a. After curing period has elapsed, remove curing compound without damaging concrete surfaces by method recommended by curing compound manufacturer unless manufacturer certifies curing compound will not interfere with bonding of floor covering used on Project.
  - 4. Curing and Sealing Compound: Apply uniformly to floors and slabs indicated in a continuous operation by power spray or roller according to manufacturer's written instructions. Recoat areas subjected to heavy rainfall within three hours after initial application. Repeat process 24 hours later and apply a second coat. Maintain continuity of coating and repair damage during curing period.

### 3.9 CONCRETE SURFACE REPAIRS

- A. Defective Concrete: Repair and patch defective areas when approved by Architect. Remove and replace concrete that cannot be repaired and patched to Architect's approval.

### 3.10 FIELD QUALITY CONTROL- When specified or required

- A. Testing and Inspecting: Owner will engage a qualified independent testing and inspecting agency to perform field tests and inspections and prepare test reports.
- B. Testing Services: Tests shall be performed according to ACI 301.
- C. Structural concrete pours shall have a third-party testing and inspection.

### 03 15 16 Concrete Construction Joints

For expansion and control joints in sidewalks and other flatwork areas:

All expansion joints shall have a width of 1/2", doweled every 12" along the width of the sidewalk, with a redwood filler with snap cap. After concrete cure snap cap to be removed and sealed with poured joint sealant.

Expansion joints at 20'-0" spacing along the length of the sidewalk with saw cut control joints equidistant between expansion joints no greater than 10'0" apart

Follow the standard details for control and expansion joints in Appendix G, Figure 53.

## 04 Masonry

### 04 21 13 Brick

Brick is the predominant construction material on campus and is an appropriate exterior wall material because it is a low maintenance material.

The university has a selection of standard brick selections including the "Hurley blend." Brick in unusual colors is not appropriate.

Stone sills, copings and story-bands are typically used to articulate the mass of a brick envelope. (Refer to the UNT Campus Master Plan and Design Guidelines)

For structures removed from the heart of the main campus, the Designer may consider other exterior materials. However, there must be compelling reasons for using other materials and other means must be used to integrate the structures into the fabric of the campus.

#### 1. Unit Masonry

##### A. Construction Tolerances

- a. Variation from plumb: for vertical lines and surfaces of columns, walls and arises do not exceed 1/4" in 10', or 3/8" in a story height not to exceed 20', nor 1/2" in 40' or more. For external corners, expansion joints, control joints and other conspicuous lines, do not exceed 1/4" in any story or 20' maximum, nor 1/2" in 40' or more.
- b. Variation from level: for lines of exposed lintels, sills, parapets, horizontal grooves and other conspicuous lines, do not exceed 1/4" in any bay or 20' maximum, nor 3/4" in 40' or more.
- c. Variation of linear building line: for position shown in plan and related portion of columns, walls and partitions, do not exceed 1/2" in any bay or 20' maximum, nor 3/4" in 40' or more.
- d. Variation in cross-sectional dimensions: for columns and thickness of walls, from dimensions shown, do not exceed -1/4" nor +1/2".

**B.** UNT Project Manager will determine whether a Mock-up of unit masonry is required. Size of Mock-Up will be specified by Project Manager.

**C.** Face brick installed at the jobsite shall not exceed the range of color, texture, finish, size, chipping, cracking, and imperfection or tolerance effects exhibited by the final accepted mockup.

##### D. Job Conditions

- a. Store and handle masonry units off the ground, under cover, and in a dry location. If units become wet, do not place until units are in an air-dried condition.



- b. Prevent grout or mortar from staining face of masonry to be left exposed or painted. Remove immediately grout or mortar in contact with such masonry. Protect base of walls from rain-splashed mud and mortar splatter by means of coverings spread on ground and over wall surface.
- c. Protect sills, ledges and projections from droppings of mortar.
- E.** For all exterior exposed units, provide standard manufacturer's units of dense aggregate (ASTM C33). Dense aggregate units are to include an integral water *repellent* agent in the mix.
- F.** Provide stainless steel anchors and ties at cast stone installations. **Do not** use corrugated metal ties.
- G.** Do not lower freezing point of mortar by use of admixtures or anti-freeze agents. Do not use calcium chloride in mortar or grout.
- H.** Strike joints facing cavity, flush.
- I.** Provide anchoring devices of type shown and specified in construction documents. For conditions not shown or specified, provide standard type for facing and back-up involved.
- J. Lintels**
  - a. Install loose lintels of steel and other materials where shown.
  - b. Provide masonry lintels where shown and wherever openings of more than 1'-0" are shown without structural steel or other supporting lintels. Provide precast or formed-in-place masonry lintels.
  - c. For hollow masonry unit walls, use specially formed "U" -shaped lintel unit-with reinforcing bars placed as shown and filled with Type S mortar or concrete grout.
- K. Control & Expansion Joints**
  - a. Provide vertical expansion, control and isolation joints in masonry. Build-in related masonry accessory items as masonry work progresses.
  - b. If location of control joints is not shown, place vertical joints spaced not to exceed 30'-0" o. c. Review location of joints with Architect before execution.
- L.** Remove and replace masonry units which are loose, chipped, broken, stained or otherwise damaged, or if units do not match adjoining units as intended.  
Provide new units to match adjoining units and install in fresh mortar or grout, pointed to eliminate evidence of replacement.

## **2. Stonework**

- A.** Fabricate and install stonework to withstand normal loads from wind, gravity, movement of building structure, and thermally induced movement, as well as to resist deterioration under conditions of normal use including exposure to weather, without failure.
- B.** Provide stonework which is designed, fabricated and installed based on the following safety factors applied to minimum physical properties of stone indicated.
  - 1. Safety Factor for Limestone and Sandstone: 8
    - a. Provide hand-set stone anchoring system which results in attachments developing the capability to sustain the following forces generated by the supported element (individual member or assembly) acting separately, based on the yield strength of the material:
      - b. A total force of 4 times the dead weight of the element supported, applied vertically downward through the element's center of gravity, combined with loads caused by thermal movements.
      - c. A total force of 2 times the dead weight of the element applied horizontally outward through the center of gravity of the element, combined with loads caused by thermal movements.
- C.** Quality Assurance

1. Obtain each color, grade, finish, type and variety of stone from a single quarry with resources to provide materials of consistent quality in appearance and physical properties, including the capacity to cut and finish material without delaying the progress of the work.
2. Obtain mortar ingredients of uniform quality and from one manufacturer for each cementitious and admixture component and from one source or producer for each aggregate.
3. Obtain each type of stone accessory, sealants and other materials from one manufacturer for each product.
4. Prepare mock-ups for the following types of stonework when required by UNT Project Manager. Purpose of mock-ups; is further verification of selections made for color and finish under sample submittals and establishing standard of quality for aesthetic effects expected in completed work. Build mock-ups to comply with following requirements:
  - a. Locate mock-ups on site where indicated or, if not indicated, as directed by Architect.
  - b. Build mock-ups for the following types of stonework:
    - i. Typical exterior stone-veneer-faced masonry wall, approximately 6' long by 4' high.
  - c. Retain mock-ups during construction as standard for judging completed stonework. When directed, demolish mock-ups and remove from site.

**D. General Materials**

1. Comply with referenced standards and other requirements indicated applicable to each type of material required.
2. Provide matched blocks from a single quarry for each type, variety, color and quality of stone required. Extract blocks from a single bed of quarry stratum, especially reserved for Project, unless stones from randomly selected blocks are acceptable to Architect for aesthetic effect.

**E. Limestone**

1. Mock-up of limestone is required, minimum 6 feet wide by 4 feet high.
  - a. No random lengths smaller than 12".
  - b. The limestone with yellow/orange coloring needs to be more randomly placed.
  - c. The textured/roughest side of the limestone needs to be placed to the exterior.

**F. Mortar and Grout Mixes**

1. Do not add admixtures including coloring pigments, air-entraining agents, accelerators, retarders, water repellents agents, anti-freeze compounds, or calcium chloride, unless otherwise indicated.

**G. Stone Fabrication**

1. Finish exposed faces and edges of stones to comply with requirements indicated for finish under each type and application of stone required to match approved samples and field-constructed mock-ups.
  - a. Cut stones from one block or contiguous, matched blocks in which natural markings occur.
  - b. Arrange panels in blend pattern.
2. Carefully inspect finished stones at fabrication plant for compliance with requirements relative to qualities of appearance, material and fabrication; replace defective stones with ones that do comply.
3. Grade and mark stones for overall uniform appearance when assembled in place. Natural variations in appearance are acceptable if installed stones match range of colors and other appearance characteristics represented in approved samples and field-constructed mock-ups.

**H. Adjusting and Cleaning**

1. Remove and replace stonework of the following description:
  - a. Broken, chipped, stained or otherwise damaged stones. Repair will be allowed only to the extent the results are acceptable to the Architect.
  - b. Defective joints.
  - c. Stones and joints not matching approved samples and field-constructed mock-ups.

2. Replace in manner which results in stonework matching approved samples and field-constructed mock-ups, complying with other requirements and showing no evidence of replacement.

## 05 Metals

### 05 05 23 Metal Welds

All welds to be cleaned of slag and primed prior to painting to prevent rusting.

### 05 52 00 Metal Railings

Railings should be brushed stainless steel or gloss black color powder coated/baked enamel depending on architectural design of the building or context. Refer to Appendix G, Figure 36 for post mounting detail.

To prevent skateboard use at railings or walls, use skateboard blocks or nobs at any places identified as potential opportunities for damage from skateboards.

## 06 Wood, Plastics, and Composites

### 06 22 00 Millwork

1. Cabinetry and Shelving
  - A. Build cabinets out of cabinet-grade plywood, preferably 7-ply veneer.
    1. No particleboard or fiberboard.
    2. If we are using a melamine interior of cabinet, it will be permissible to use particle board melamine.
  - B. No interior shelving in cabinets to be longer than 32 inches without installing sufficient nosing to support shelf from sagging, or a center divider that will cut the shelf in half to prevent shelves from sagging in the middle.
  - C. All face frames and styles to be made from hardwood, not plywood.
  - D. Cabinet shelving can be either stationary or adjustable. KV #233 or peg adjustable shelving is sufficient.
  - E. Use Blum concealed hinges, #B71T555 and 120 degree opening. Other hinges are permissible with prior approval from Project Manager to specify quality and finish of all hardware.
2. Wall Shelving
  - A. Box shelving unless otherwise specified.
  - B. Shelf standards should be #KV 80 or #KV 187, and no further apart than 24 inches.
  - C. Anchor all standards to the studs, or use toggle bolts.
3. Countertops
  - A. All countertops should have 4-inch backsplash unless otherwise approved by the Project Manager.
  - B. All countertops shall be sufficiently supported with angle braces, supports to the floor, cabinets, and no more than 36 inches apart.

- C. Use solid surface countertops. Note: Quartz may not be cut or otherwise disturbed once on the job site as it creates an environmental hazard that does not meet UNT's indoor air quality standards. See Project Manager for colors and material selection.
  1. Permissible to build countertops out of particle board and/or a good industrial fiber board. Most manufacturers only warranty the laminate product if it is laminated on particle board or a good industrial fiber board. Use recommended base for countertops as recommended by the laminate manufacturer.

## 07 Thermal and Moisture Protection

1. General
  - A. All walls will be insulated with a minimum of R-13 rating or as specified by the Project Manager.
  - B. Flat roof designs are not allowed.

### Roofing

#### General

Building evaluation and consideration should be given to provide infrastructure for future solar panels.

#### Standard Specifications

Four-ply modified bitumen roofing system to include a base sheet, two intermediate fiberglass felt plies and a granular surfaced polymer reinforced modified bitumen cap sheet applied in mopping of hot asphalt over rigid insulation boards.

Standard four-ply specification is to be used in new construction where LEED certification points are not relevant to the project.

The insulation system should be a two-layered system over a steel deck, consisting of a base layer of rigid insulation board mechanically fastened to the deck in compliance with FM 1-90 wind uplift resistance, followed by a top layer of rigid insulation board set in a mopping of hot asphalt.

#### Slope

Roofs must have a minimum slope of one quarter (1/4) inch-per-foot on new structures.

On existing structures, less than one quarter (1/4) inch-per-foot is acceptable provided the roofing manufacturer offers a 15-year warranty (depending on roofing system chosen). UNT Facilities will make all final decisions in these instances.

#### Design Parameters

Select roof systems which are suitable for the facility. To evaluate possible systems, the consultant will consider the following design parameters:

1. Life of the roof system. Preferred systems and associated useful lives include:
  - a. Single Ply 60 mil
  - b. Modified Bitumen (SBS) – 20 years
  - c. Composition shingles – 25 years
  - d. Metal

- e. Preformed architectural
- f. Structural standing seam
- g. Architectural – custom fab
2. If other systems, such as PVC, TPO, CSPE/Hypalon, mechanically-attached EPDM, APP type modified bitumen are, in the opinion of the consultant, the most appropriate system, it will be evaluated by the project team.
3. Initial (first) cost of the roof system and additional building costs required for recommended roof system.
4. Maintenance costs and requirements.
5. Energy costs associated with recommended roof system.
6. Building height/roof slope/wind resistance requirements.
7. Present and future use of building, including specific uses in the building that could affect the roof system.
8. Local environmental issues/contaminants and pollutants.
9. Life expectancy of building.
10. Structural properties of roof superstructure.
11. Type of roof deck.
12. Slope/drainage.
13. Vapor retarder requirements.
14. Roof traffic/access and penetrations.
15. Code/Insurance requirements and restrictions.
16. Aesthetics.
17. HVAC internal pressures.
18. Application issues, such as staging, access, building use and occupancy, etc.
19. New roofs shall have safety lines installed for future maintenance and repairs. Safety lines shall be installed in cases where there is an upper “flat” roof that provides access to a sloped roof.
20. Protect existing roof surface during construction.
21. Provide permanent walk surface to new roof top equipment on new roofing systems and / or existing where new equipment is being installed.

After establishing design parameters, evaluate roofing systems based upon:

1. Minimum established UNT standards
2. A choice of roof systems with properties that, considering all factors, are best suited to the project
3. Requirements for a total system warranty

The consultant will follow these roofing guidelines when designing the roofing system:

1. Do not install single-ply ballasted roofs or coal tar roofs.
2. Do not use lightweight concrete as a means to create slope on new buildings. On re-roofs, it may be used to repair existing decks and create slope.
3. Provide 1/4 inch-per-foot slope for new buildings, accomplished by sloping the structure.
4. If an existing roof has less than 1/4 inch-per-foot slope, evaluate if achieving 1/4 inch-per-foot is feasible.
5. Due to health hazards and indoor air quality issues, coal tar pitch shall not be used. The only exception is to patch an existing coal tar pitch roof, and then it may only be used during a night shift job.

6. Use crickets, saddles, and edge strips to direct water flow away from parapets and penetrations. Back slope is to be confirmed during detailing.
7. Overflows are required by code. Overflows shall not be piped into the primary roof drain system.
8. Provide roof walkways to and around rooftop equipment and other areas as directed by the owner.
9. At the design development phase, a review should be undertaken by the consultant to include vapor retarder requirements deck type, expansion joint locations and details, salvage ability of existing roof insulation, drainage, roof access, roof contaminants, fire rating, and wind uplift factors, and all other applicable parameters.
10. Existing roof decks will be checked by a registered structural engineer if roof loads are in question.
11. On re-roof projects, where a consultant is utilized, an evaluation will be done by the consultant and the owner. Core samples and other testing results will be recorded and evaluated.
12. Roof access will be evaluated, and roof access hatches, ladders and other components will be installed as required by the owner.
13. Avoid complex flashing details. Minimize use of pitch pans or sealant pockets. Maintain minimum 8" flashing height, 12" is preferred.
14. Minimize roof penetrations. If structural penetrations are unavoidable, use round or square structural steel shapes to facilitate flashing. Equipment supports for rooftop mounted equipment shall be a minimum 14" height. Use prefabricated equipment supports where possible. Equipment support frames or stands shall provide following working clearances:

Width of Equipment (inches)	Height of Legs (inches)
Up to 25	14
25 – 37	18
37 – 49	24
49 – 61	30
Over 61	48

15. Provide safe and lockable roof access with UNT master core. Provide permanent ladder(s) to all roof levels. Permanently affixed ladders should be a minimum of 8 inches from wall. Roofs with numerous mechanical devices, such as exhaust fans on laboratory buildings, must have one stairwell or ships ladder extend to the roof.

## 08 Openings

### 08 10 00 Doors and Frames

1. General
  - A. Minimum door size 3'0" width and 70" height.
  - B. Frameless glass doors are not permitted. Use hollow metal doors with glass panels.
  - C. Other acceptable door system options: knock-down frames with solid core wood doors, anodized aluminum storefronts.
  - D. Exterior double doors must have a lockable, removable mullion.

- E. All metal storefront frames are 4" wide.
- F. Metal door frames are for a 4-7/8" set up for 3-5/8" metal stud with 5/8" sheetrock on both sides. All door openings require wood reinforcement.

### 08 41 00 Entrances and Storefronts

#### 1. General

- A. Provide an air lock or vestibule at each entrance to the building for energy conservation purposes and thermal comfort.
- B. Preferred entry floor mats and frames are recessed aluminum frame with carpet type insert. Carpet and backing insert will be Class 1 fire rating with a minimal pile weight of 32 ounces per square yard. Color will be from manufacturer's available standards. Coordinate with UNT Project Manager. Cocoa fiber products are not acceptable. Consideration should be given to branding opportunities within the carpet at entries. Also, consideration should be given to carpet selection that meets LEED certification requirements.

Acceptable manufacturer's products:

- a. Tandus Centiva Abrasive Action II
  - b. Tarkett Action II
  - c. Patcraft: Foot In The Door II
  - d. Mohawk: Tuff Stuff II
  - e. Bentley: Rough Idea
  - f. Forbo Coral Brush Activ
- C. Glaze exterior storefronts with insulated glass in 4-1/2" thick frames that conform to fire codes.

### 08 42 29 Automatic Entrances

Where ever possible, automatic door openers shall be installed on main entry doors to a building and in at least one individual restroom per floor.

Door openers should be tied into the electronic locking access control system, so openers shut down when the building is locked. The openers shall be hard-wired into the building's electrical system, no battery-operated openers allowed without prior approval.

### 08 50 00 Windows

#### 1. Glazing

- A. Use double-glazed Low-E insulated windows in conditioned spaces. The orientation and solar gain potential of windows is always an important consideration; however, the use of mirror glass is discouraged.
- B. When possible, provide windows that can be washed on both sides from inside the building. When that is not possible, provide safety belt anchors placed on the outside of all windows. Provide guardrails on windows with sills less than two feet from the floor.

#### 2. Exterior Windows

- A. Windows are not desirable in auditoriums, but they are desirable in public areas and offices. In general, do not extend windows below 30 inches above the floor or more than seven feet above the floor in offices. The general orientation of the building should consider the east and west solar exposure in the arrangement of windows and glass to minimize direct sunlight.

## 08 71 00 Door Hardware

1. General
  - A. All new buildings require an electronic locking system.
    1. Standard Card Reader Schlage MTMS15
  - B. All hardware shall be lockable from inside the room.
  
2. Door Closers
  - A. All door closers will be supplied by L.C.N. only, and the two series to be used are the 4040 and 1461. The 4040 series is for hollow metal, solid wood doors, and exterior wide style storefront doors. The 1461 series is for interior storefront narrow style doors.
  - B. Finish will match frame, unless otherwise specified.
  - C. Installation will meet all factory specifications and provide positive latching of locking hardware and the smooth operation of the door.
  
3. Exit Devices
  - A. All exit devices will be Von Duprin 99 or 33 depending on style of door.
  - B. Trim style 996L storeroom function unless otherwise specified.
  - C. Finish will be 26D, unless otherwise specified.
  - D. Installation should meet factory specifications, using proper fastening devices, thru bolts and screws to install device. Shall be installed to provide positive latching and proper function of trim.
  
4. Cylindrical Locksets
  - A. Best 93K heavy duty grade one, lever lockset.
  - B. Function specified by Owner.
  - C. Finish will be 26D, unless otherwise specified.
  - D. Rose and handle will be 26D, unless otherwise specified.
  - E. Installation should meet factory specification and provide positive latching and function of hardware.
  
5. Cores
  - A. All cores shall be UNT-restricted Best Preferred keyway to match University system, unless otherwise specified.
  - B. Keying cores shall be performed by Dormakaba – Best Access Systems. Distributor is Fairway Supply.
  - C. Provide seven (7) pin construction cores during construction.
  - D. Owner will install all permanent cores.
  - E. Rose Style to be type D (3" convex-no ring), unless otherwise noted.
  - F. Contractor should request keying instructions from UNT Access Control a minimum of eight (8) weeks in advance of installation to provide to factory to pin cores for UNT.
  - G. Contracted jobs with less than 20 cores will be handled in-house by UNT Facilities. Contractor should order and deliver uncut keys and un-combined cores to UNT Facilities for orders of 20 or fewer cores (can be sent factory direct).



### 08 81 00 Bird Safety Glass

In order to prevent bird collisions on exterior glazing effectively, provide glass that birds can detect as an obstacle. Acceptable solutions include laminated glass containing a film with a pattern or a coating or other glass tested system that is approved by owner.

1. Bird Safe Glass will be considered on a case-by-case basis for window renovations on existing buildings with large expanses of exterior window glass
2. Glass system to be tested by the American Bird Conservatory
3. Patterned insert should disappear from human sight at 6 feet.

## 09 Finishes

1. Selection and Procurement
  - A. The University requires a review period for all interior finish selections, and the UNT Project Manager will coordinate the review and approval of interior finishes. Upon receipt of approvals or revisions, the Designer shall incorporate this information into the Construction Documents. As a general rule, custom designed colors and interior finish materials are discouraged due to the difficulty in replacement during maintenance and repairs.

### 09 50 00 Ceilings

1. General
  - A. Ceiling fans are not permitted without university approval.
  - B. Outlets above the ceiling are not allowed – All electrical connections above hard or lay-in ceilings must be hard wired with a disconnect switch.
  - C. Do not use concealed spine or tongue and groove ceiling systems.
  - D. Drywall ceilings should be limited to consistently wet areas (such as cage and cart wash areas, kitchens, bio-safety Level 3 or larger facilities) and soffits in special public areas.
  - E. Maintain access to the plenum space.
  - F. Follow a 2' x 2' module for lay-in ceilings.
  - G. Rockfon Artic Square Lay-in ceiling tile is an acceptable option for high-humidity areas.

### Ceiling Tile

1. No tegular ceiling tile.
2. No particle board ceiling products
3. Lay-in ceiling tile must be non-directional.
4. Must meet ANSI S12.60 Classroom Guidelines: Items 1713, 1714, 1810, 1811.
5. 30-year warranty against sag, mold and mildew.
6. Meet at least an acoustic value of 0.55 NRC.
7. Low end option: Armstrong Fine Fissured #1728
  - A. 24"x24"x5/8" White
  - B. Use with 15/16" Prelude XL suspension system
8. High end option: Armstrong Calla #2820
  - A. 24"x24"x1" Square lay-in with high acoustic value
  - B. Use with 15/16" Prelude XL suspension system

## 09 60 00 Flooring

1. General
  - A. When selecting or recommending any flooring materials, consider safety, maintenance and future repairs or replacement. Painted or rough brick floors are not permitted.
2. Vinyl Composition Tile
  - A. Use commercial grade with 'through pattern' vinyl chip construction, minimum 1/8" thickness.
    1. For heavy loads, use 3/32" thickness.
  - B. Must provide initial waxing upon installation.
3. Sheet Vinyl Flooring
  - A. Use commercial grade, acid resistant with integral base sheet vinyl flooring.
  - B. Solid weld rods.
4. Luxury Vinyl Tile
  - A. Minimum of 20 mil wear layer.
5. Metal, Resilient, and Wood Edge Floor Transitions and Edge Protection
  - A. Must meet accessibility guidelines
  - B. Coordinate with Project Manager for final selection.
6. Porcelain and Ceramic Tile
  - A. Must meet current ANSI A137.1 Standard Specifications
  - B. Use ceramic or porcelain tile on shower floors.
  - C. Restroom floors shall be ceramic tile or terrazzo.
  - D. No custom-colored ceramic tile is permitted.
  - E. All ceramic tile floors shall have a ceramic tile base with an acid resistant grout. The grout on the floor should be a medium range color. No white grout.
7. Carpet
  - A. All carpet is part of the construction contract and specified by the Designer.
  - B. Consider only contract, commercial grade carpet. Minimum 10-year wear warranty required.
  - C. The University has standard carpet specifications and a list of the major manufacturers' carpet lines that meet the specifications. The Designer is not required to use the Owner's list of manufacturers; however, the carpet must meet the specifications and ADA requirements.
  - D. The Designer is requested to minimize the number of carpet types and colors. Solution dyed/yarn dyed preferred – no piece dyed goods.
  - E. Modular carpet is preferred. Modular carpet tile will have a minimum 20 oz. per square yard, same yarn specifications as twelve-foot (12') goods. Direct glue carpet.
  - F. Broadloom may be used with prior approval. Roll goods broadloom shall have a minimum of 18-20 tuff bind with branded yarn, nylon, and minimum 28 oz. per square yard. Cut pile broadloom carpet is not permitted. Installation shall be direct glue down.
8. Wall Base
  - A. Unless otherwise approved, wall base shall be rubber 4" high cove type base – no straight base.
  - B. No pre-formed molded pieces. Light colors are not preferred.

### 09 72 00 Wall Coverings

Wallcovering is permitted only in showcase areas with prior UNT approval.

All wood paneling and acoustical wallcovering shall be Class “A” fire-rated for vertical surfaces. The flame spread ratings of walls and ceilings shall comply with NFPA 101 -Life Safety Code.

Do not use wallcoverings in high traffic areas or locations where people may regularly come in contact with the surface (especially classrooms).

No interior brick or masonry walls where people may regularly come in contact with the surface.

### 09 91 13 Exterior Painting

All exterior building colors require approval from the University.

The palette of color on the exterior of buildings throughout the campus is derived from the use of "UNT Blend" brick and light-colored stone, or trim. When selecting specific colors that will identify location of image, be mindful of guidelines referenced in the “Colors for Materials and Finishes” section of the Design chapter.

Paint or factory finish exterior finishes, fixtures and containers (including lamp posts, bicycle racks, bollards, posts, barriers, drinking fountains, street signs, trash receptacles) must approved by UNT Project Manager.

All exterior hand rails, stair railings and any other exterior railings on campus should be gloss black finish dependent on location and architectural context.

Exterior equipment, such as air conditioner compressors, mechanical equipment and the like, may be required by the University to be painted.

### 09 91 23 Interior Painting

UNT maintains a current list of approved standard paint colors and finishes. The UNT Project Manager shall provide the applicable current list, as requested.

When selecting specific colors that will identify location of image, be mindful of guidelines referenced in the “Colors for Materials and Finishes” section of the Design chapter.

Paint should be Sherwin Williams or an approved manufacturer of equal quality. When specifying interior paints, refer to the requirements below for the sheen (or equivalent):

- Offices: “Harmony” eggshell
- Trim: “ProClassic” semigloss
- Corridors and Classrooms: “Harmony” semigloss

## 10 Specialties

### 10 11 00 Visual Display boards

Dry erase or whiteboard wall covering is NOT allowed.

For classrooms and other locations where writing surfaces are needed “glassboards” are preferred. Manufacturer: Clarus or similar.

- ¼” glass
- Clarus float or similar
- Clarus TruMount clips or similar
- ~~Matte~~ Matte Silk finish or similar
- Diamond White finish or similar
- Tempered Glass
- Edgework – Flat polish
- Boards shall be 5 feet in height and maximize width on the instruction wall to maximize writing surface area.
- Boards shall include marker tray that runs the entire length of the board.

Porcelain or ceramic visual display boards may be acceptable in certain applications. For these type of marker boards:

- No melamine boards
- Rimmed Porcelain or Ceramic material is acceptable
- Uses Standard sizes 2’x3’ to 4’-8’

### 10 14 00 Signage

#### Room Numbering

Interior spaces, including mechanical equipment rooms and custodial closets, receive a unique room number, with the sequence of these numbers such that it shall aid a visitor's orientation within the building. This room numbering system is 100’s for the first floor, 200’s for the second floor, etc. Suites of rooms will all have the same number with a letter suffix, for example 206A to 206Z.

UNT Facilities Director of Facilities Planning, Design & Construction or delegate will establish room numbers. The Designer is required to coordinate during the Design Development phase prior to committing numbers to paper. Once the room numbering system is established during the Design Development phase review, it may be modified thereafter. The room numbering system on the construction documents will match final room signage.

#### Exterior Signage

The Designer is expected to comply with UNT Signage standards. Refer to Appendix G Figures 15, 16, & 19 while preparing the required signage drawings and specification. This work is to be considered as part

of the Designer's basic scope of work unless stated otherwise in the Owner-Designer contract agreement

### Interior Signage

The Designer is expected to comply with UNT Interior Signage standards. (Appendix G, Figures 17 – 22) Typically new buildings and total building renovations conform to Gray/White Romark Substrate sign, and existing building partial renovations conform to Cinder/Green/White Romark Ultra-Matte detailed sign while preparing the required signage drawings and specification. This work is to be considered as part of the Designer's basic scope of work unless stated otherwise in the Owner-Designer contract agreement. The signage package should include all materials, labor and installation of all components including graphics, bulletin boards and building directories. Signage submittal should include a schedule and floor plans for review by UNT.

### Residence Hall Evacuation Signage

For residence halls, Designer must provide evacuation maps and signage for each residential room that will be mounted on the inside of the entry/exit door.

These maps must be custom-designed for each room using these standard map elements:

- A title, "Evacuation Plan"
- The name of the building and floor
- The statement "IN CASE OF FIRE, GO TO NEAREST EXIT. DO NOT USE ELEVATORS. FOR EMERGENCIES CALL 911."
- A map legend
- The entire architectural floor plan layout
- The room number of the room being evacuated
- A primary evacuation route from the room – the shortest path to an exit
- A secondary evacuation route from the room – the second shortest path to an exit
- A "You Are Here" symbol for the room being evacuated
- A symbol representing each exit from the building

For each map, the floor plan must be oriented so that the person evacuating the room can read the evacuation routes and understand if they move left or right out of the room.

These signs shall be printed vinyl with a laminate that is anti-graffiti and fire resistant. SEAL Print Shield Anti-Graffiti 1 mil gloss overlamine or equal product is acceptable.

### Building Signage

For new buildings, the Designer is expected to make provision for a UNT standard building sign. See Appendix G, Figures 15, 16, and 21. Coordinate the procurement and installation of the building sign with the UNT Facilities Sign Shop.

Signs other than building signs are typically masonry backing with anodized raised letters, masonry raised or recessed letters. The Designer will discuss these signs with the Owner, if appropriate.

### Building Plaque

For new buildings, provide a cast bronze dedication plaque. The Designer shall provide an appropriate setting for installation of the memorial plaque. The University will furnish the exact wording and specifications for the plaque provided by the contractor.

### Exterior Site Signage

Use three-inch (3) steel square tubing with a powder coated black finish in ten-foot lengths to install exterior informational signage, such as signs for parking, bus stops, or traffic. Ensure the post is installed twenty-four (24) inches deep. Coordinate the procurement and installation of the building sign with the UNT Facilities Sign Shop.

### 10 41 16 Emergency Key Cabinets

Use KnoxVault 4400 DUAL LOCK Model, recessed mount, color black.

Install five feet from walking surface to top of Knox box, and within five feet of the building access point. See Appendix G, Figure 41.

### 10 43 13 Defibrillator Cabinets

Use Cardiac Science AED Surface Mount Wall Cabinet, part # 50-00392-10.

See Appendix G Figure

### 10 73 43 Transportation Stop Shelters

The University, in consultation the University Parking and Transportation Department, shall determine where to locate bus stop shelters when ridership volumes justify use and adequate space is available.

The design of bus shelters shall be coordinated between UNT Facilities and UNT Parking and Transportation Department. Provide appropriate illumination and transparency to ensure user security and safety.

Provide a suitable clear space around the shelter to allow for visual accessibility and maintenance.

Integrate related site furnishings, such as waste receptacles, lighting, newspaper machines, and landscaping features, into the space surrounding the shelter. Provide a fixed sitting surface inside the shelter.

## 11 Equipment

Concrete equipment pads must have 3/4" chamfered edges on all edges horizontal and vertical.

### Rooftop Equipment

The University requires that Designers minimize the visual impact of any items located on roofs. The University prefers not to have equipment placed on the roof. However, where rooftop equipment is necessary, the design shall minimize penetrations of the roofing system.

Provide maintenance access walkways to all rooftop equipment.

Equipment mounted on rooftops should be located a minimum of 15' from the edge of the building. In rooftop locations where a minimum of 15' is not feasible, contractor shall install OSHA-Compliant tie-off anchors or a safety rail system depending on the current UNT-Approved building code.

### Fixed Equipment

Designer shall coordinate infrastructure, space and code requirements for any Owner provided fixed equipment (such as lab equipment, sterilizers, dishwashers, ice machines, etc.) that will require hard wiring or plumbing connections.

Dishwashers and in-sink waste disposals are not allowed in typical office service breakrooms. Specialty service areas may require them in which case a Design and Construction Standards Exception Form should be submitted.

### Moveable Equipment

The University purchases and installs all moveable equipment, such as microwaves, refrigerators and centrifuges.

### Equipment hangers and anchors

All equipment hung from above shall have an engineered fastening system design.

Exterior piping, and cables, associated with roof top equipment installation, must be properly supported on rubber support blocks and strapped with metal or UV resistant cable ties.

## 12 Furnishings

### 12 20 00 Window Treatments

The Designer shall specify blinds or other window coverings. The general contractor shall purchase and install them as part of the general contract.

The preferred window treatment specification for residence halls is as follows:

- Preferred Vendor – Texton, or equal
- For bedrooms - Blinds – 1” Bali classic – 8 gauge mini-blinds in Snow Cap White
- For common areas/lounges – manual roller shades with 4” fascia; Fascia in White, shade in White/Bone

### 12 30 00 Casework

#### Laboratories

New laboratories shall have fixed personal accessory storage outside of the lab space or in the entry space closed off from the lab.

## 12 50 00 Furniture

### Selection and Procurement

For the specification, selection, and procurement of furniture for all projects, make every effort to coordinate furniture issues during all phases of the project, especially during the Design Development and Construction Document phases.

The Designer shall provide final floor plans to the University for preparation of furniture layouts. See Appendix G, Figure 27 - 32 for typical furniture configurations.

### Lighting

All furniture attached “Work Lights” shall have T5 or LED lamps.

### Layout Coordination

Prior to the completion of the Construction Documents, review and coordinate all furniture layouts with the building systems including thermostats, electrical outlets or junction boxes, lighting, telephone and data outlet locations.

### Installation

Furniture installer is required to remove all furniture packaging materials after installation is complete.

### Modesty Panels on Modular Furniture

Where modular furniture “case goods” rest against hard walls, partial-height modesty panels must be specified for power and telecommunication access.

## 14 Conveying Equipment

### 14 20 00 Elevators

Thyssenkrupp is the sole source provider of elevator installation and maintenance services. No other subcontractor is allowed.

New buildings should have a minimum of two passenger elevators, with one adequate to serve deliveries to the upper floors. Design all passenger elevators to comply with accessibility codes. Except in unusual situations, elevators are not designed for exclusive use as freight elevators. If the building size and nature is sufficient to justify a passenger elevator near the front of the building and a freight elevator at the service entrance to the building, the designer is encouraged to do so.

Design elevators and elevator machine room equipment to provide smooth and quiet operation. Isolate sounds and vibrations from the building structure.

Provided the elevator hoist ways and elevator machine rooms are not sprinkled, shunt-trip shut-off devices are neither required nor permitted. See Policy on Elevator Shunt-Trip Devices in Appendix G, Figure 33.

Design elevators to return to the ground (exit) floor upon activation of fire alarms.



Provide an electrical receptacle in the corridor on each floor adjacent to the elevator landing for housekeeping purposes.

Installation vendor/contractor will be responsible for all maintenance and service during the warranty period. Response to non-emergency service calls will be within four hours of the call. Response to emergency service calls will be within one-half hour of the call. Vendor will be financially responsible for these calls except those caused by power outages, acts of God, vandalism, and false reports.

Equip all hydraulic elevators with PVC containment piping encasing the cylinder ram and casing. Seal containment at the bottom. Provide a means of testing the bottom seal and a means of evacuating any material that may enter the containment. Prevent any materials from entering the top of the containment.

Provide a sump hole and pump in all elevator pits. Provide an electrical GFCI outlet by the sump hole. Sump pumps shall be indirectly pumped to sanitary sewer through an oil separator. The Owner will make final determination based on ground water conditions. Size of control and pump system to be determined based on ground water conditions.

Do not install hydraulic piping underground.

#### Elevator Pit Sub-drainage:

For all buildings: install waterproofing on sides and bottom of elevator pits. Waterstop all concrete joints.

For buildings without an under-slab drainage system regardless whether footing drains are used: Install a groundwater collection sump pit in room close to elevator pit and with the bottom of the sump pit at least 2 feet below the bottom of the elevator sump pit.

For buildings with an under-slab drainage system: Install the sub-drainage at an elevation below the elevator sump pit elevation.

#### Elevator Controller

In addition to normal elevator specifications, the following must be included:

The elevator power controller shall utilize a microprocessor-based logic system and shall comply with ANSI/ASME 17.1 safety code for elevators. The system shall provide comprehensive means to access the computer memory for elevator diagnostic purposes without the need for any external devices, and shall have permanent indicators to indicate important elevator statuses as an integral part of the controller. All diagnostics shall be non-proprietary. Systems that require hook-up of external devices for troubleshooting and adjusting are not acceptable.

#### Elevator Equipment Rooms

Provide convenient access to pits and equipment rooms. Do not use elevator equipment rooms for access to roof or other parts of the building. Access to elevator equipment rooms is not permitted through housekeeping or other such space. Each elevator pit shall have a work ladder and a light installed with the switch easily accessible from the door.

The elevator pit shall be acid etched and finished with one coat thinner 50/50 and then one un-thinned coat of gray porch and deck synthetic enamel.

Elevator equipment rooms shall have sufficient ventilation or cooling to limit the maximum temperature in the space to 90-degree Fahrenheit. If exterior supply air is provided, filter the intake. Ventilation fans should be sidewall mounted if possible. If necessary to install roof mounted fan, install a permanent ladder for access.

The elevator mechanical equipment room shall have LED fixtures mounted above, in front of, and behind all control circuit panels. Provide adequate lighting for the hoist machine.

If elevator mechanical equipment room for a traction elevator is located on the bottom floor, provide LED lighting at the top of the hoist way with a work platform, a light switch and adequate access.

Provide a safely accessible ladder and platform for any mechanical equipment room above roof level.

The penthouse, where necessary, shall have a minimum seven-foot (7') ceiling and shall have sufficient ventilation or cooling to limit the maximum temperature in the space to 90-degree Fahrenheit. If exterior supply air is provided, filter the intake.

## 21 Fire Suppression

All penetrations through firewalls shall be sealed per AHJ standards.

Approved fire caulking type:

- 3M Fire Barrier Sealant CP25WB+
- Hilti FS One Max Firestop Intumescent
- or equivalent. (To be reviewed and approved by AHJ).

Cable tray penetrations or other larger penetrations through fire walls and or smoke walls shall be sealed.

Approved products:

- 3M Fire Barrier Pillow
- Hilti Firestop Block CSF-BL
- or equivalent (To be reviewed and approved by AHJ).

### 21 11 16 Fire Hydrants

Coordinate the location of fire hydrants with the UNT Project Manager and the City of Denton.

### 21 13 00 Fire Sprinkler Systems

The Designer shall comply with all specifications issued by the University of North Texas System Fire Marshall. Contact the University of North Texas System Facilities office to obtain the most current specifications for the fire alarm system.

Refer to Appendix C Fire Protection System Specifications.

All buildings will have fire suppression systems per applicable codes: NFPA 13, NFPA 13D, NFPA 13R, NFPA 14, NFPA 20, NFPA 24.

Design all new buildings with automatic fire sprinkler systems throughout the building. Type of system to be determined per application.

Materials and equipment will be approved, listed, and labeled for fire sprinkler installation.

Design sprinkler systems in accordance with NFPA for the application intended. Install fire sprinkler systems per NFPA.

Include hydraulic calculations in sprinkler shop drawings.

Locate all test valves in mechanical rooms in central locations with easy access.

Install a pressure gauge on the main supply of each sprinkler system, upstream from the main test valve.

Provide drainage for all test locations that is sufficient to carry the full flow of water that can be expected during testing of the systems. This is particularly important at the location for testing the main drain of a system.

Size fire fighter's manifold connection according to requirements of the local fire district.

All sprinkler systems will have an addressable fire alarm panel installed to monitor all water flow alarms, supervisory alarms, and trouble signals of the system.

Where a sprinkler system is to be installed in a non-heated area, it is preferred a dry-pipe system be installed rather than a chemical system.

Provide a double-check type backflow preventer for all sprinkler systems installed at the point of building entry.

Locate backflow device inside the mechanical room rather than exterior pits.

Sprinkler systems with fire pumps require a test loop and flow meter.

Hydrant flow testing is required as part of sprinkler system design.

## 22 Plumbing

Any contractor performing plumbing work on UNT property will be in possession of, and provide proof of current State of Texas Plumbing License. Comply with the latest edition of the International Plumbing Code.

Provide updated valve schedule with all renovation and new construction projects. Prominently identify fire protection valves at each valve location.

### Piping General

Use of mechanical joints for domestic water piping is preferred over soldered connections.

Bolt standard for flange connections: ASTM A193 grade B7: Alloy steel, AISI 4140/4142.

Use of Uponor PEX A piping is approved for domestic cold and hot water piping up to 3" in size.

Install all piping, conduits, etc. in the ground adjacent to buildings parallel to, or perpendicular to, the building structure. Independently support all equipment, conduits, piping, etc. from building structure. Hangers and supports for equipment, piping, and conduits should be double nutted top and bottom.

All piping systems will be labeled, color coded with the type of service per ASHRAE, (for refrigerant piping, indicate the type) and the direction of flow. Place lettering at intervals of approximately 20 feet on straight runs of piping including risers and drops, adjacent to each valve and fitting, and at each side of penetrations of structure or enclosure. Lettering will be visible from the floor. For pipes 3/4-inch and smaller, use permanent phenolic tags.

Tag all valves with a stamped brass or stainless-steel tag describing type of service and area controlled by the valve. Provide valve list for all valves located in the mechanical rooms.

Provide shut-off valves at all pipe branches and where required to facilitate partial system isolation.

When water is turned off for more than 5 days in a building affecting restrooms, replace flush valve components to existing water closets and urinals at the end of renovations. Clear debris from sink aerators.

All equipment, fixtures, or other appliances attached to any piping system will have a shut off valve located at the connection to the piping system.

All valves will be located with sufficient room for maintenance or replacement.

Install manual type air vents in water systems at high points in the system.

Mechanical joint piping systems (Victaulic, etc.) are acceptable.

Do not use Armaflex type insulation on dual temperature piping.

All underground piping will have a minimum earth cover of 36 inches to the top of the pipe.

All underground piping systems will have a #12 AWG copper wire attached to the pipe for a tracing wire. Label and terminate wire in an accessible location. No splices in the wire are allowed.

All insulated exterior, exposed piping will have an aluminum jacket installed to protect the insulation. Jacket will be weather-resistant, waterproof, smooth surfaced aluminum with a minimum thickness of 0.016 inches.

All insulated interior piping that is exposed in occupied areas, and is within 6 feet of the finished floor, will have a PVC jacket installed, color-coded per ASHRAE.

All insulated interior piping that is exposed in mechanical rooms will have a color-coded PVC jacket (per ASHRAE) installed.

Domestic water line insulation will be insulated with fiberglass insulation. Mechanical rooms with piping six feet and lower will have a protective jacket.

All piping systems, unless specified below, will be tested at a minimum of one and one-half times the expected working pressure, or a minimum of 100 psi and a maximum of the design pressure of the pipe and fittings. Test all systems for a minimum of four hours with no more than 5 lb. of pressure. If more than 5 lb. pressure loss, detailed written explanation and or repairs required.

When test pressure exceeds 125psi, test pressure will not exceed a value which produces a hoop stress in the piping greater than 50% of the specified minimum yield strength of the pipe.

- Natural gas: test at twice the working pressure or a minimum of three psi.
- Sanitary sewer: test at 10 foot of head pressure for no less than four hours.

Thrust blocks shall be designed to meet the needs of the project and application.

### Piping Penetrations

All penetrations of foundation walls will be leak proofed.

All penetrations, except steam tunnels, will be individual pipes or conduits. Groups of pipes or conduits in a common penetration is not allowed.

Minimum thickness of steel pipe penetrating foundation walls will be equal to Schedule 40; PVC pipe to be equal to Schedule 80, and installed with a steel sleeve.

Escutcheons to be used when piping penetrates through wall.

Recommended seal for wall penetrations is "Link-Seal" or approved equal.

Copper Viega ProPress, Nibco, or an approved equivalent pressed fittings for domestic pipe up to 4" approved for use on campus.

### Access Panels

Provide adequately sized access panels, 24"x 24" where possible. Ensure alignment of access panel with valves/components to pipe chases and valves above ceilings or otherwise concealed. Under rooms which have reasonable possibilities of water in them, such as rest rooms with floor drains, provide

access panels in plaster or gypsum board ceilings. Access panels should not require a special tool to unlock.

Provide access to manifolds with integral factory or field-installed valves.

Provide enough access to all full-open valves and shutoff valves.

## 22 05 25 Valves

### Backflow Preventers

Reference Table 22-01 next page for specific requirements.

Protect fixture valve outlets with hose attachments, hose bibs, and lawn hydrants with an approved back-siphonage backflow preventer or vacuum breaker on the discharge side of the valve. Each building must have a reduced pressure zone device backflow preventer with a sediment strainer/trap on the water main. The design will be such that the debris can be flushed from the trap without interrupting water to the building.

Watts brand to be used for backflow devices. Other manufacturers must be approved by UNT Plumbing Department. Wilkins is not an acceptable manufacturer.

All domestic water systems will have backflow prevention devices at the point of building entry. No metering devices, taps, or other fittings will be located upstream of the backflow preventer. However, if a common supply serves both the domestic water system and the fire protection system, it is preferred the two systems be split immediately upon entering the building. Install the backflow preventer for each system at this point. Where water is critical for research, animal care, etc. install two backflow preventers sized at 60% to avoid water outages for testing.

Locate and configure all backflow preventers to allow ready accessibility for maintenance and testing. Provide a minimum clearance of 24 inches of free area in front of backflow preventer for accessibility.

No backflow preventers will be located more than 4 feet above floor level.

Pit installations of backflow preventers will not be allowed.

Drainage from backflow preventers must be possible by gravity only, either to a floor drain or to surface of the ground.

New installation of backflow devices must be tested after the installation by a Texas licensed backflow tester that is registered in the City of Denton, the completed and approved backflow test form must be left at the device for the UNT final inspection

**Table 22-01**

**Definitions:**

**Health Hazard** is defined by water used for human consumption

**Non-Health Hazard** is defined by water that is used for other than human consumption.

**AG** – Air Gap

**DC** – Double Check Valve Assembly

**PVB** – Pressure Vacuum Breaker Assembly

**SVB** – Spill Resistant Vacuum Breaker Assembly

**RP / RVP / RPB** – Reduced Pressure Principle Valve Backflow Assembly

<b>Equipment Assembly Type</b>	<b>Acceptable Backflow Assemblies</b>	<b>Required Installation Location</b>	<b>Prohibited Backflow Assemblies</b>
1. Non-health hazard assembly	DC, PVB, SVB, or RP/RVP	Installed at point of connection hazard	PVB or SVB not approved where backpressure situation exist
2. Health hazard assembly	AG, PVB, SVB, or RP/RVP	Installed at point of connection to hazard	PVB or SVB not approved where backpressure situations exist
3. Carbonated drink machines	RP, RVP, RPB, or AG	Assembly and all downstream piping shall be non-corrosive when in contact with CO <sub>2</sub> gas.	
4. Commercial-Style Coffee Machine	AG, RP, RVP, RPB		
5. Commercial Ice Maker	AG, RP, RVP, RPB		

**Isolation Valves and Unions**

All main lines and all hot/cold water lines – especially those serving group toilet rooms – shall have shut off valves for isolation purposes and valves shall be accessible. Furnish accessible water supply one-quarter turn isolation valves where each piece of equipment is connected. Install unions to facilitate removal of traps, valves, strainers, etc.

**Domestic Hot Water**

Domestic hot water heater should be electric. UNT uses small 1-10 gallon heaters at point of use (e.g., restrooms, break rooms, custodial closets). Circulating domestic hot water heaters are discouraged, but may be required in special areas such as science labs.

Use of instant water heaters is discouraged and must be approved by UNT Facilities.

Domestic hot water should not exceed 110 degrees Fahrenheit (exceptions are kitchen or lab areas).

## Drains

Provide floor drains in all equipment rooms, custodial closets, rest rooms and locker rooms with floors sloped to drains. Floor drains shall empty into the sanitary sewer. Infrequently used floor drains shall have traps resealed by trap primer or trap guard from clear water fixtures. Drains of exterior stairwells shall be a drain well with grate type cover.

Public restrooms with more than one station will have a floor drain located under a stall partition. Provide plumbed drain lines for hand dryers.

All horizontal drains shall be provided with cleanouts located not more than 100 feet apart.

## Safety Showers and Eyewash Stations

Provide emergency eyewash stations and/or safety showers where chemicals harmful to the body and eyes are handled and stored. Supply safety showers and eyewash stations with tepid water at no more than 30 psi. Provide an audible alarm when the safety shower is activated.

No floor drains allowed in safety showers.

## Water Pressure

Designer to be aware that Denton water pressure is maintained at lower pressures (35 – 50 psi) than other cities in the Dallas/Ft. Worth metroplex and that a booster will be required on any multiple story building design.

Anticipated domestic water pressure on top floor of high-rise buildings shall be stated. Provide pressure reducing valves in high pressure areas. Due to wide seasonal fluctuations in the City of Denton's water pressure and to allow the building main water tap to be downsized thus reducing tap fees, all of UNT's new construction is to have duplex house pumps, and, if required, a fire sprinkler pump. Pre-design water pressure readings should not be relied upon as the sole source of information regarding normal operating pressure. Do not connect cooling tower water supply to domestic water supply; should be connected to irrigation supply, or connected to its own meter.

## 22 40 00 Plumbing Fixtures

### General

Kohler, Crane, and American Standard are acceptable manufacturers for porcelain toilets, urinals and sink basins.

New toilets at 1.6 gallons per flush, and new urinals at .5 gallons per flush. All fixtures should be commercial grade, and white in color.

All fixture hardware (faucets, flush valves, etc.) will be chrome.

All faucets, urinal & water closet flush valves will be automatic. Battery operation is preferred. Campus standard is Sloan auto flush valves and auto sink valves. Hands-free flush valves will have a manual override function.



T&S or Chicago faucets are preferred.

T&S or Chicago shower valves are preferred, and must be anti-scald mixing valves.

Provide Saniflow dual flow plus M12a hand dryers with plumbed in drain line.

Provide StepNpull (stepnpull.com) foot operated door openers on pull side of door.

Provide Dyson Airblade HU02 V Series and HEPA filtration, Dyson Airblade Tap combo faucet with heat, or approved equal. Provide a solid surface down to the cove base when these fixtures are installed on the wall. Note: Quartz may not be cut or otherwise disturbed once on the job site as it creates an environmental hazard that does not meet UNT's indoor air quality standards.

### Fixture Mounting

Install all wall-mounted toilets and sinks using chair carriers for extra stability, strength and security.

### Distilled Water

T&S or Chicago faucets are preferred. Piping system should be all PVC or PurePipe. Mixing of the two piping types and systems is not recommended.

### Water Coolers

All water coolers will be refrigerated type. Halsey Taylor or approved equal are preferred.

### Building Sewers

Provide cleanouts no more than 100 feet apart for building sewers, measured from the upstream entrance of the cleanout.

### Changes of Direction

Install cleanouts at each change of direction greater than 45 degrees (0.79 rad) in the building sewer, building drain and horizontal waste or soil lines. Where more than one change of direction occurs in a run of piping, only one cleanout shall be required for each 40 feet of developed length of the drainage piping.

### Base of Stack

A cleanout shall be provided at the base of each waste or soil stack.

### Building Drain and Building Sewer Junction

There shall be a cleanout near the junction of the building drain and the building sewer. The cleanout shall be either inside or outside the building wall and shall be brought up to the finished ground level or basement floor level. An approved two-way cleanout is allowed to be used at this location to serve as a required cleanout for both the building drain and building sewer. The cleanout at the junction of the building drain and building sewer shall not be required if the cleanout on a 3-inch or larger diameter soil stack is located within a developed length of 10 feet of the building drain and building sewer connection.

### Manholes

For building sewers 6 inches and larger, provide manholes and locate them no more than 200 feet from the junction of the building drain and building sewer, at each change in direction, and at intervals of not more than 400 feet apart.

Manholes serving a building drain shall have secured gas-tight covers. Manholes and manhole covers shall be of an approved type.

## 23 Heating, Ventilating, and Air Conditioning (HVAC)

### 23 08 00 Commissioning of HVAC

UNT will provide air balancing outside of the general contract. UNT Air Balancing contractor must be provided with plans and specifications at the plan review phases. Comments from Air Balancing contractor should be addressed in the same manner as owner's comments.

### General Design

A building air conditioning, heating and ventilation system should provide a safe and adequate environment suitable for the functional programs supported by the building as well as providing a comfortable environment for the occupants. Special purpose facilities will require special definition of appropriate interior design conditions.

In the design of HVAC and electrical systems, consider different building utilization during various seasons or times of the day – plan for conservation of energy during summer and winter vacations and for other periods of minimum occupancy. For example, research laboratories and spaces for animals (and other spaces which might require operation 24 hours per day) should be served by systems separate from offices (which might operate only 10 hours a day) and classrooms (which might shut down during summer and vacation periods).

Outside winter design temperature is zero degrees Fahrenheit for 100% outside air units.

Provide preheat coils for air handlers with entering air mixed temperature below 35-degree Fahrenheit.

Locate preheat coils downstream of heat reclaim coils. Size preheat coils with the heat reclaim not operating.

The HVAC Designer should consider waste heat recovery, the utilization of outside air for cooling and the use of enthalpy controllers whenever possible. The Designer should use the pulse width modulation (PWM) type of adjustable frequency fan drives for variable volume systems.

Design electrical lighting systems for maximum efficiency consistent with required minimum lighting levels. Use natural lighting to the maximum extent practical.

Use energy efficient motors for all motors 1 HP and above.

Do not site fan coil units on the roof.

Piping coming out of unit should be supported within 12" of unit at first available joint.

### Ventilation

Auditoriums and Lecture Halls: Design of air handling systems for auditoriums should consider use of CO2 monitors and occupancy monitors to control the amount of outside air required.

Re-circulation: The building air conditioning system may re-circulate air from the office, classrooms, and similar areas; however, there must be no reintroduction into the building supply system of air delivered to mechanical rooms, toilet rooms, laboratories, or other areas where supply air may become contaminated.

Escutcheons to be used when duct and or hydronic piping penetrates through wall.

Make-up Air: Provide outdoor make-up air to all occupied spaces, including computer rooms according to ASHRAE Standard 62-1989R "Ventilation for Acceptable Indoor Air Quality".

Location of Air Intakes: The location of air intakes should be remote from sources of pollutants and the building air intake and exhaust outlets shall be remotely located from each other to prevent contamination. Take special care to ensure that exhausts from hoods, emergency generators etc. is not pulled into the building through make-up or fresh air intakes. Install hardware cloth on outside of louver to eliminate leaves, debris, etc. from lodging behind louvers, and painted the same color as the louvers.

100% Outside Air: Provisions should be made for use of 100% unconditioned outdoor air whenever ambient conditions satisfy design and humidity requirements.

## Equipment Location and Access

### Outdoor Equipment Location

Mount condensers and allied equipment at ground level on concrete slabs appropriately screened with attractive fencing or plantings.

### Roofs

Refer to the Rooftop Equipment in Division 11.

Equipment mounted on rooftops should be located a minimum of 15 feet from the edge of the building. In rooftop locations where a minimum of 15' is not feasible, contractor shall install tie-off anchors or a safety rail system.

### Mechanical Rooms

Place mechanical equipment inside mechanical rooms. Do not mount mechanical equipment above the ceiling or in similar locations where access is difficult.

Size mechanical rooms to provide adequate space for normal maintenance and change out of components, including pulling tubes for converters and hot water generators, and coils in air handling units. Provide adequate means of access for replacement of the largest piece of equipment without removing walls.

Include doors or panels for maintenance access to plumbing, heating and air conditioning components.

Provide sufficient LED lighting and duplex outlets to enable maintenance to plug in lights, operate small tools, drills, etc. Do not obstruct lighting with ductwork and piping – column and wall mounted lighting is acceptable, as necessary to maintain lighting coverage.

Adequately ventilate the room by a fan.

Provide appropriately sized floor drains. Provide a minimum of one (1) Domestic City Water (DCW) hose bib for cleaning coils and flooring.

### Equipment Access

Access to major equipment and working platform surfaces for employees shall be convenient and safe. For large pieces of equipment, an industrial stairway may be required in accordance with 29 CFR 1910.24(b).

Terminal boxes shall be located so that space and access is provided for service and filter change.

If fan powered variable air volume (VAV) boxes are to be used in ceiling, mount them above entrance doors and access panels at ceiling height.

Installing fan coil units above ceilings is not preferred. Provide access for service of unit and filter change. If ceiling mounting is the only alternative, provide recess mounted units.

Provide a secondary drain pan for all concealed units with condensation pans. Design the secondary drain pan piping to drain to the available janitor sink, floor drain, or as directed by the Project Manager. Extend the secondary pan past primary clean-outs. Use un-insulated Schedule 40 PVC piping for secondary drain lines when above ceilings in finished space. Provide enough slope to secondary drain lines for gravity flow, and properly support the pipe. Place a water sensor in the secondary drain pan to shut the A/C unit off in case the secondary drain backs up. Connect the water sensor to the EMCS.

Primary drain-pan line should have union at the p-trap for "clean out" accessibility.

Mount all control equipment (relays, starters, etc.) where they are accessible without having to use a ladder.

### Condensing Units for Walk-in Boxes

Water-cooled condensers are required where cooling water is available. Air-cooled condensers must be placed outside building.

### Refrigerant

In compliance with EPA requirements, it is unlawful to release Group I or Group II refrigerants containing CFC's (chlorofluorocarbons) and HCFC's (Hydro-chlorofluorocarbons) into the atmosphere.

Modify existing equipment to either contain or reclaim refrigerants or to replace very old and inefficient equipment. All new equipment must be compatible with more acceptable refrigerants, such as R-123, R-134a or R-410a.

Refrigerant lines to be supported by a professional manufactured grade material on rooftops.

## Air Handling Systems

### General

1. Variable Air Volume (VAV) systems are preferred. Fan Powered VAV shall not be used. Controls and re-heat piping must be accessible without insulation removal. Preferred VAV manufacturer is Titus, or approved equal.
2. Economizer cycles are preferred but should be evaluated on a cost/benefit basis. If an economizer cycle is used, a return air fan is required to prevent over pressurization of the conditioned space.
3. All systems using 100% outside air should be evaluated for use of heat recovery systems.
4. Pitot tube test port stations will be provided in all locations as required to determine fan system or zone air volumes.
5. Air handling units will consist of factory fabricated components.
6. The preferred manufacturers for AHU's are Trane, Temtrol, ClimateCraft or an approved equivalent.
7. A drawing will be mounted near the air handling unit showing as-built locations of all fire dampers, balancing dampers, VAV boxes, coils, and other equipment in the ductwork served by that unit. The drawing will be protected by glass or other suitable material.
8. Large systems are preferred over small multiple systems.
9. 8. HVAC Pumps
  - a. All HVAC pumps shall be frame mounted mechanical seal.
  - b. All HVAC Pumps with VFD's shall have TB Woods Duraflex couplers or approved equal.
10. 9. VFD's
  - a. ABB and Square D are acceptable manufacturers.
11. Piping coming out of unit should be supported within 12" of unit at first available joint
12. Rooftop units to be attached to curbs.
13. Rooftop unit installs shall include frost proof hose bib on rooftop, within 50' of new install.

## Air Handling Units

1. Air handling unit sections will be factory fabricated. Desired air handling unit features include:
  - a. Full-sized access sections between all coil and filter sections. Access sections will have an electric light;
  - b. Hinged access doors will be provided on all units to provide access to filters, coils, fans, dampers, etc. Door handles will be used on these doors. Bolted panels are not acceptable except on very small units.
  - c. Side loading or upstream loading filter banks.
  - d. Filter sections shall have access doors on both sides of AHU.
  - e. Direct drive fans – such as fan wall units – should be considered where feasible to reduce maintenance cost and eliminate a point of failure due to belt breakage.
2. Exterior units will be designed specifically for outdoor installation. All piping will be within the unit enclosure.
3. On new construction, and existing buildings where possible, locate all air handling units inside the building or in a penthouse. Rooftop and above ceiling locations are not preferred. VAV boxes should be located in corridors or other common areas whenever possible.
4. All units will provide thorough mixing of outside and return air. Designer will evaluate the need for engineered mixing boxes, blenders, or other methods to prevent stratification of the air.

5. Sufficient space will be maintained between heating and cooling coils so air stratification is eliminated.
6. Filters will comply with ASHRAE Systems and Equipment Handbook, Chapter 25, Table 2.

### Supply & Return Fans

1. Fans will be selected to provide highest efficiency and lowest noise characteristics practical while meeting specific system requirements. Recommended level is 85db, five (5) feet from the unit.
2. Fan type and characteristics will be selected to assure stable non-pulsing performance in required operating ranges. Air foil fan wheels are preferred.
3. Variable speed drives will be considered for fans having 3 HP or larger motors.

### Exhaust Fans

1. Fan motors up to 15 HP, fans with belt drives will be provided with adjustable pulley sheaves. Midpoint of adjustment will be at design condition.
2. Fans with motors larger than 15 HP, fixed non-adjustable drives in which motor pulleys of different diameter can be used, will be provided.
3. The motor selected will have adequate fan/impeller inertia capacity and torque capability to bring the fan to full operating speed in less than 20 seconds. Appropriate starting devices and overload relays to tolerate this time period will be selected.
4. Fans will comply with AMCA Standard 210 and ASHRAE Standard 51.

### Coils

Coils will be certified by ARI STD. 410.

### Filters

1. Filters will comply with ASHRAE.
2. Final filter efficiency is a minimum of 60% or per ASHRAE, whichever is more stringent.

### Dampers

1. Outdoor air intake dampers will conform to AMCA Standard 500. The air leakage rating across the damper when closed will not exceed 6 cfm/sq.ft., at 4" water column static pressure differential.
2. Volume dampers will be opposed blade.
3. All balancing dampers will lock in position.
4. Position of all dampers will be marked on the shaft of the damper by use of a groove or saw kerf.
5. Fire dampers will be in accordance with NFPA 90A and with a UL approved fusible link.

### Ductwork

1. All main and branch ductwork will be constructed of galvanized sheet metal per SMACNA. Construction will include the use of sealant.
2. Mechanical, metal jacketing bands to be used on elbows per SMACNA details.
3. Fabrication and installation of the turning vanes will conform to latest SMACNA Standards.
4. Maximum leakage for all duct systems is 3%. All ducts will be tested per SMACNA.

- a. All branch duct takeoffs will use the 45-degree design and will have a balancing damper installed in each branch as close to the main duct as practical. No splitter dampers or air extractors will be used.
5. Only external insulation will be used.
6. Flexible ductwork will have a maximum length of 6' and will be properly supported.
  - a. Provide a typical support detail on the drawings. Flexible ductwork will only be used for connecting the branch duct to the diffuser. In no case will flexible ductwork be used upstream of VAV boxes.
  - b. Hangers and supports for equipment, piping, and conduits should be double nutted top and bottom.
7. Use of duct liner may be used for sound attenuation in return air systems within 10' of air handling unit. Use of fiberglass duct liner is prohibited; use of sound attenuator is preferred.
8. Where used for sound dampening, double wall duct with exposed insulation edge shall be sealed to prevent becoming air borne. All open ducts shall be temporarily sealed during construction until final connections are made. Construction filtration must be properly maintained throughout project.
9. Duct access panels and doors will be provided on the entering air side of all dampers and turning vanes. Panels and doors will be large enough to allow for maintenance of HVAC device. Size will be coordinated with UNT Facilities Maintenance.

### Diffusers

1. Diffusers with integral dampers will not be used. Balance damper shall be located at all branch ducts for balancing purposes.
2. Perforated supply diffusers will not be used.
  - a. In a suspended ceiling installation, it is preferred diffusers use a 24" x 24" mounting plate. A small diffuser mounted in a large ceiling tile is not acceptable.
3. Diffusers for VAV systems will be specified with consideration given to air dumping at low velocities.
4. All turning vanes will be airfoil type.

### Fume Hoods and Laboratory Systems

#### General

1. All systems, whether new or replacement, should be designed using VAV (Variable Air Volume) hoods.
2. If the complete exhaust-supply system cannot be installed at time of fume hood installation, VAV controllers for the new equipment will be installed at a minimum. This may require a constant velocity type fume hood be installed. If so, select a fume hood that can be converted to a VAV type fume hood.
  - a. All fume hood systems will be designed according to ANSI Z9.5. Design face velocity will be 100 FPM at full sash. Use a proximity sensor to reduce face velocity to 70-80 FPM when no one is in the immediate vicinity of the front of the fume hood.
  - b. For all fume hood installations or alterations, the balance of make-up air to exhaust air for the affected zone or building will be evaluated. Fume hoods that will cause or aggravate an imbalance between the makeup air and exhaust air will not be installed unless the imbalance is corrected. The preliminary design for a project may proceed on



the basis of existing drawings and/or balance data. The final design must be based on actual test data.

- c. Supply air diffusers will not be located in front of a fume hood. Design per ASHRAE guidelines. (i) Fume hood shall be located out of traffic ways, preferably in corners with one foot from the perpendicular wall.
- d. Fume hoods in laboratories are to remain in place. It is against UNT practice to move fume hoods from one location to another due to the unique HVAC requirement and equipment specific to a given location.

### Exhaust System

1. All exhaust fans should be direct drive with motors isolated from the exhaust air stream.
2. Exhaust Systems will be designed in accordance with the latest edition of the Industrial Ventilation Manual by the American Conference of Government Industrial Hygienist.
3. Manifold central exhaust systems are preferred over individual exhaust systems where feasible.
4. Perchloric and radioactive systems will be completely separate from other exhaust systems.

### Fume Hoods

1. All fume hoods should be equipped with a face velocity monitor and markings on the front of the hood indicating maximum sash opening height and sash height for maximum air flow.
2. All fume hoods must be certified by Risk Management Services (RMS) prior to use.
3. All fume hoods should have half-sash locks with alarms. Alarms may have a user override but, if the override is used, will alarm again after four minutes.
4. All fume hoods will have flow indicators with low flow alarms.
  - a. Vertical sashes are preferred. The use of horizontal sashes is discouraged.

### Ductwork

1. All fume hood and laboratory exhaust system ductwork will be constructed with
  - a. 304 stainless steel and will be of welded construction unless other materials are required by the uses of a particular system.
2. Exhaust ductwork through occupied areas will be under negative pressure and exhaust fans will be located on the roof.
3. All exhaust branch lines shall have blast gate type dampers at the connection to exhaust main duct to provide branch isolation while the main exhaust system is in operation.

### Controls

1. Control fume hood exhaust, room exhaust, and room supply airflows with a VAV scheme to maintain a constant fume hood face velocity of 100 FPM and to provide climate comfort control for the room occupants.
2. Control equipment will be by Phoenix Controls. Phoenix Controls are UNT Denton Campus standard for lab exhaust controls. Airflow control devices will be pressure independent venturi type valves.
3. Any control system used will have a response time of 1 second or less.
4. Use sash position type of control design, not air pressure differential.

## Animal Quarters

1. Design parameters for animal quarters will include 100% outside air, 100% exhaust, heat recovery on exhaust air, and a 50% safety factor on total heat load.
2. Verify required space temperatures with ultimate user of the space.
3. Install hot water preheat coils with freeze proof protection (e.g., constant water flow in freezing temperatures).

## Water Cooling Systems

The Designer must consider the following when designing the building hot/chilled water systems:

1. The cooling coils and heat exchangers must be designed for variable flow, constant temperature differential.
2. The building pumps must be selected for the building system head and flow requirements. Variable volume pump is required; Bell & Gossett pumps are the standard. Pumps larger than 7 ½ Hp will have mechanical split seals.
3. The control valves and control systems on equipment served by the chilled water system must be capable of accurate low load control and close off across the building pump shutoff head. The shutoff head requirements can be lowered if a variable volume pump is used.
4. Once through cooling of equipment is not allowed.

## Interior Chilled Water Systems

### *Piping*

1. PVC will not be used for chilled water systems above ground.
2. Welded steel systems will use black steel piping and fittings, ASTM A53, Schedule 40. Minimum pipe size will be 3/4".
3. Copper systems will use a minimum of Type L copper.
4. Any threaded black steel pipe shall be schedule 80.
5. Mechanical grooved piping systems are acceptable. Use stainless steel nuts and bolts to secure grooved piping systems.
6. Direct burial piping to be HDPE, not metal.

### *Valves*

1. Control valves, for pipe sizes smaller than 3" will be ball valves. For pipe sizes equal to or larger than 3", control valves will be butterfly valves. All control valves on chilled water systems shall be two-way.
2. Isolation valves, for pipe sizes 2" and smaller, will be ball valves. For pipe sizes larger than 2", isolation valves will be butterfly valves.
3. Balancing valves 2-1/2" and smaller will be plug valves. For pipe sizes larger than 2-1/2", butterfly valves will be used.
4. Butterfly valves will be resilient seated with bronze or stainless-steel discs and will be bubble-tight. All butterfly valves will be lug-type and gear operated.
5. Valves to be labeled on ceiling grid or any access panel for location verification.

### *Insulation*

1. All insulation will be fiberglass, flexible unicellular foam, or cellular glass.

### Chilled Water Distribution Loop

1. All systems will be two pipe systems.
2. Material for chilled water loops will be HDPE piping (or approved equal) with appropriate fittings to make a ductile iron connection to the building pipe system.
3. All fittings will be installed with UL listed and approved retainers.
4. Isolation valves will be installed inside the building at each building service entrance. Isolation valves are also required at the branch connection to the main. The isolation valve will be a gate valve, installed with a valve box, located as close as practical to the main line.
5. All loop systems will be provided with a means of air relief at all high points. The preferred method for air relief is a manually operated ball valve located underground in a meter box or similar enclosure.

### Chillers

1. Preferred manufacturers are Carrier, Trane, and York (or equivalent approved by Facilities).
2. Refrigerant types R123 or R134a, or approved equivalent.
3. No free cooling package on chillers. Free cooling plate heat exchangers are allowed.
4. Condenser and evaporator barrels to be equipped with marine heads at piped ends with hinged heads.
5. LON compatible chiller control interface to Schneider Electric EMS system.
6. Variable speed chillers are preferred.
7. Chiller installation shall be designed to minimize noise and vibration.
8. Chiller installation to allow for ease of maintenance to include tube brushing and oil changing.
9. Refrigerant Monitor will be required. Model to be approved.
10. Mechanical room ventilation shall be designed to meet the current ASHRAE code.

### Cooling Towers

1. UNT standard for cooling towers is an induced draft, counter flow, field erected cooling tower within a reinforced concrete structure and related accessories. Avoid placing cooling towers or condenser on the roof when possible. Preferred location is on the ground near the mechanical room. If the condenser pump is in the mechanical room, water must gravity flow from the cooling tower to it.
2. If space is not available for a permanent structure, stainless steel cooling towers are acceptable, but may require screening or fencing. Construction should be stainless steel without galvanized or FRP components. Evapco, BAC, Marley are acceptable manufacturers.
3. Cooling tower fan final drive shall be right-angle gear, or direct drive fan motor. Belt drive is not acceptable.
4. Cooling tower shall be installed with maintenance access to basin, spray heads and gear boxes.

### Building Heating System

1. The heating system shall be stand-alone per building using hot water boilers.
2. 1.5 million BTU and above shall be AERCO Benchmark boilers.
3. Boilers shall be natural gas fired.
4. Designer shall consider gas pressure on UNT campus. Pressures vary significantly across campus.
5. LON compatible boiler control interface to Schneider Electric EMS system. Control system shall allow staging of boilers to meet heat load, and to operate with individual unit local control.
6. Accessibility for routine maintenance.

7. Boilers shall be installed on a minimum 4” housekeeping pad.
8. Hot water supply and return isolation shall be butterfly valves.
9. Each boiler shall be vented independently.
10. Common heating water supply and return temp sensors are required and shall be connected to Schneider Electric EMS system.
11. Mechanical room ventilation shall be designed to meet the current ASHRAE code.

### Central Utility Distribution System

The UNT Central Utility Plant maintains and operates a hot/cold water distribution system serving part of the University campus.

GPM	LENGTH (FT)	PIPE SIZE (IN)
0 – 150	0 – 400	4
150 – 250	0 – 200	4
	200 – 1000	6
250 – 600	0 – 250	6
	250 – 1000	8
600 – 1000	0 – 400	8
	400 – 1000	10
1000 – 1500	0 – 500	10
	500 – 1000	12
1500 – 2000	0 – 800	12
	800 – 1200	14
2000 – 4000	0 – 500	14
	500 – 1000	16

Consider the following items when preparing the bridge performance table:

1. Average return temperature from all building loads at design conditions (Designer must calculate this value). This average return temperature will be the set point for TCVA. A return temperature of 59 degrees Fahrenheit is preferred and 55 degrees Fahrenheit is the minimum acceptable return temperature.
2. Supply temperature for all building loads at design conditions (Designer must calculate this value). The supply temperature must not be less than 40 degrees Fahrenheit, with a maximum supply temperature of 49 degrees Fahrenheit. Provide a separate interface if specific equipment needs a lower supply temperature.
3. Total flow for all building loads at design conditions (Designer must calculate this value).
4. Chilled water flow in distribution system branch connections to building at design conditions (Designer must calculate this value).
5. All new chilled water systems will be Primary/Secondary building pump systems with 2-way control valves. The secondary systems will have variable speed pumps and 2-way control valves.
6. Condensing water systems will be equipped with automatically controlled water treatment and blowdown systems designed to control scale buildup, corrosion, and concentration of dissolved solids. Blowdown will be piped to Spirotherm (or approved equal) drain line.

## 25 Integrated Automation

### Energy Management and Control System (EMCS)

A Schneider Electric based control system monitors and controls electrical, heating, ventilating and air conditioning (HVAC) systems at UNT, with control strategies built into it for electrical, hot water, and chilled water load shedding required to balance available supply with priority level demand.

Connect all new HVAC equipment located at the building level to the University's Schneider Electric Energy Management and Control System (EMCS). In order to standardize this System, a guide has been created (see Appendix E).

All variable frequency drives (VFD) shall have LON card installed on each drive.

### EMCS Design Requirements

All terminal units shall be electronic direct digital control (DDC) by Schneider Electric (e.g., box damper controls, reheat coil valves, and electronic room sensors).

All air handling units shall have electronic control devices (e.g., chilled water valves, hot water and steam valves, return air, outside air and relief/exhaust air dampers) and have DDC controllers wired back to a common terminal strip using sensors and wiring specified by UNT.

Do not use EMCS power and LAN wires as tie wires to support adjoining equipment. Contact the Project Manager before removing any electronic thermostats; or, cutting or removing any control wiring.

Remove all un-used branch pneumatic air lines back to the main line and cap them.

All reheat and preheat converters shall contain electronic control valves controlled by DDC controllers wired back to a common terminal strip using sensors and wiring specified by UNT.

### Utilities Metering Equipment Guidelines

The University of North Texas Facilities Support & Services manages and operate 13.2kV electrical distribution system, and District Energy System at UNT Denton Main Campus.

UNT facility management requires that any facility that connects to any of the services mentioned above be provided with whole facility instrumentation and metering devices meeting this guideline sufficient to determine the consumption of the various utilities connected to the facility. Facilities that do not connect to UNT utilities may be required to meet the guidelines based on the project scope and program.

### Integration into Power Monitoring System

The **Power Monitoring Expert** is a networked metering, monitoring and verification system comprised of hardware, software, and PME server by Schneider. This guideline includes the facility hardware and software but the project budget must fund all component of the installation including hardware, software, commissioning and installation requested by UNT FM and paid for by the project.

## General

This document covers the metering guidelines for typical UNT facility utility metering. The utilities to be metered are Chilled Water, Natural Gas, Domestic Water and Electric.

## Electricity Metering

- A. All submeters shall be installed in or at the electrical Main Switchgear or Switchboard and shall be provided with matching Current Transformers “CT’s” and any required Primary Transformers. **(Labels the CT’s ratios on the Construction Drawings or at the nearest location of the meter).**
  - a. Where required by the project, additional sub-metering may be necessary on building branch circuits. All such meter shall meet this guideline.
- B. **For Critical Load** such as Data Centers and Research Labs: Meter shall be **PowerLogic ION 7550** high performance meters or a prior approved equivalent by UNT Energy Engineer.
- C. **For Non-Critical Load** such as Dormitory, Education and General Buildings, Athletics complex, etc.: Meter shall be **PowerLogic PM8000** or prior approved equivalent by UNT Energy Engineer.
- D. **For Individual Sub-Metering** such as Stand-alone kiosk, Parking Lights, or Temporary Contractor ties: Meter shall be **PowerLogic Energy Meter, PowerLogic EV55 socket style meter**, or prior approved equivalent by UNT Energy Engineer. Provide support to the socket meter.
- E. **Output communication of all the meters shall be BACnet or Modbus over IP via the Ethernet Card.**
  - a. To match the building standard, electric submeters can connect to the nearest Ethernet switch via **CAT5/6E** cable requested by UNT PM.

## Chilled Water, Hot Water and Process Water Metering

- A. Chilled Water meters shall be Onicon F-3500 Insertion Electromagnetic with System 10 BTU meter display or prior approved equivalent by UNT Energy Engineer for all thermal energy in sizes 1¼” and up.
- B. CHW meters shall be integrated to the UNT campus network PME via MODBUS TCP/IP **(Meters must communicate DIRECTLY to the PME).**
- C. Metering system components such as flow meters, temperature or pressure sensors may be used as a control point for a building automation system **(BAS)**.
- D. Contractor shall validate the performance and accuracy of the meter and provide report to UNT Energy Engineer confirming each meter validation testing.
- E. The following readings are typically integrated into the UNT Power Monitoring Expert:
  - **Cumulative Energy in (Ton Hr)**
  - **Instantaneous water flow (GPM)**
  - **Total Flow (Gallons)**
  - **Delta T (°F)**

- **Chilled Water Supply and Return Temperature (°F)**

### Natural Gas Metering

- A. Natural Gas utility provider furnishes the meter at building level. Exceptions are made where NG utilities are shared between several facilities.
- B. **For shared NG utility:** Sub-meter shall be **positive displacement rotary flow meter by Honeywell** or prior approved equivalent by UNT Energy Engineer.
- C. Natural Gas sub meter shall have **electronic pressure recorder** featuring Modbus Protocol.
- D. Natural Gas submeters shall be integrated to the UNT campus network PME via MODBUS TCP/IP.

### Domestic Water Metering

- A. Domestic water utility provider furnishes the meter at the building level. Exceptions are made where domestic water utility are tied to existing building main.
- B. **For Shared Domestic Water utility:** Sub-meter shall be E-Series Ultrasonic Badger Meter or prior approved equivalent by UNT Energy Engineer.
- C. Contractor shall validate the performance and accuracy of the meter and provide report to UNT Energy Engineer confirming each meter validation testing.

## 26 Electrical

### 26 05 15 – Wire and Cabling

Campus wire from #12 through #8 must be solid.

### 26 27 05 – General Purpose Power and Lighting Circuits

$\frac{3}{4}$ " conduit to have no more than three circuits maximum per conduit run to allow for future growth.

### New Interior Construction Work Areas

A new interior construction work area would be a space where either all new ground up interior construction was taking place, or a full demolition of an existing interior space is being accomplished, essentially with all new interior walls. Where this type of work is occurring, the use of EMT conduit, MC Cable are understood to be as follows:

1. EMT conduit would be utilized for all connections to any electrical panel, along with all horizontal above ceiling (or possibly below floor) runs out to the various electrical device locations. All drops to devices (receptacles, switches, J-boxes, etc.) within new wall locations would be accomplished with EMT conduit run vertically only (no horizontal conduit runs within any new wall locations).
2. The understood minimum EMT conduit size for the above noted item 1 is  $\frac{3}{4}$ " C. The final EMT conduit size (and associated branch circuit conductor sizing requirements) would be based on NEC requirements (other than the noted  $\frac{3}{4}$ "C minimum size requirement) depending on the actual branch circuit loading.

3. MC cable would not be utilized for any branch circuit requirements related to any device locations within any new wall locations...all branch circuits for these new wall mounted device locations in new walls would only be in EMT conduit as indicated in items 1 and 2 above.
4. The use of interior electrical PVC conduit is prohibited per the AHJ.

### Renovation Work Areas

A renovation interior work area would be a space where existing walls are remaining, but new devices (receptacles, switches, J-boxes, etc.) are being installed within the existing walls. Where this type of work is occurring, the use of EMT conduit, MC Cable, and flexible metal conduit are understood to be as follows:

1. EMT conduit would be utilized for all connections to any electrical panel, along with all horizontal above ceiling (or possibly below floor) runs out to the various electrical device locations. The drops to devices (receptacles, switches, J-boxes, etc.) within existing wall locations would be accomplished with either MC Cable, or flexible metal conduit run vertically only (no horizontal runs within any wall locations).
2. The understood minimum flexible metal conduit size for the above noted item 1 is  $\frac{3}{4}$ " C. The final MC cable or flexible metal conduit size (and associated branch circuit conductor sizing requirements) would be based on NEC requirements (other than the noted  $\frac{3}{4}$ " C minimum flexible metal conduit size requirement) depending on the actual branch circuit loading.

### Lighting Fixture Locations (both New Construction and Renovation Work Areas)

#### Recessed Lighting Fixture Locations

Locate light switches so that the top of the box is 48" above the finished floor.

All light switches shall be labeled with the panel and circuit number.

No daisy-chaining or through wiring of lighting fixtures will be allowed.

Flat panel and recessed canned lighting fixtures installed in hard ceilings shall have accessible remote ballasts.

EMT conduit would be utilized for all connections to any electrical panel, along with all horizontal above ceiling (or possibly below floor) runs out to the various area lighting fixture locations. The understood minimum EMT conduit size for this lighting branch circuit application out to a given area from an electrical panel is  $\frac{3}{4}$ " C. The final EMT conduit size (and associated branch circuit conductor sizing requirements) would be based on NEC requirements (other than the noted  $\frac{3}{4}$ " C minimum size requirement) depending on the actual branch circuit loading.

For new construction work areas utilize EMT conduit ( $\frac{3}{4}$ " C minimum) for the vertical raceway requirements related to light fixture switch locations; for renovation work areas utilize flexible metal conduit ( $\frac{3}{4}$ " C minimum) for the vertical raceway requirements related to light fixture switch locations.

For the lighting branch circuit connections at the individual recessed lighting fixture locations (branch circuit concealed above gyp, lay-in, etc. ceilings). MC Cable could be utilized to accommodate the branch circuit connections between the recessed lighting fixtures in a given area.



The understood minimum MC Cable size for connections between recessed lighting fixtures in a given lighting control area would be 3/8" C. The final MC cable size (and associated branch circuit conductor sizing requirements) would be based on NEC requirements (other than the noted 3/8" C minimum MC Cable size requirement) depending on the actual branch circuit loading.

### Emergency Lighting

Emergency lighting relays installed in one location designated by UNT.

### Surface or Exposed to Structure Lighting Fixture Locations

EMT conduit would be utilized for all connections to any electrical panel, along with all horizontal runs out to the various area lighting fixture locations. The understood minimum EMT conduit size for this lighting branch circuit application out to a given area from an electrical panel is 3/4" C.

For new construction work areas utilize EMT conduit (3/4" C minimum) for the vertical raceway requirements related to light fixture switch locations; for renovation work areas utilize flexible metal conduit (3/4" C minimum) for the vertical raceway requirements related to light fixture switch locations.

For the lighting branch circuit connections at the individual surface or exposed to structure lighting fixture locations...EMT conduit would be utilized to a point within 6' of any lighting fixture location. MC cable could be utilized to accommodate the final 6' branch circuit connections between the surfaces or exposed to structure lighting fixtures in a given area.

The understood minimum desired EMT size for connections between the surface or exposed lighting fixtures in a given lighting control area would be 3/8". The final EMT conduit, MC cable, size (and associated branch circuit conductor sizing requirements) would be based on NEC requirements (other than the noted 3/4" C minimum EMT or flexible metal conduit size requirement) depending on the actual branch circuit loading.

### Busways

The University discourages the use of busways in electrical system design from a maintenance standpoint. The use of busway on the line (service) side of the service disconnect is prohibited. Aluminum busway is prohibited.

### Computer Room Power

Electrical service for areas used for computers or microprocessors should have:

- Dedicated circuits for computer use only.
- Isolated ground receptacle and wiring to be used in conjunction with dedicated circuits.
- Line isolation and filter transformer provided for small main frame computers.
- For large main frame or real time computers, an uninterruptable power supply should provide the power to critical components even if emergency power is available.

### Electrical Outlet Strips at Laboratories

Use only Wiremold G4000 series.

### Wireless Atomic Wall Clocks

Use Primex as the manufacturer for all wireless atomic wall clocks. Wall clock face design should conform to UNT branding standards.

### Electrical Service Time Switch for exterior lighting

Provide electrical exterior lighting control service timer at power source that will automatically adjust for changing sunrise and sunset times. Unit shall include battery back up to maintain programming during power outages.

Campus standard electrical service timer:

- Intermatic ET8015C, Astronomic 7-day programmable, daylight saving enabled
  - NEMA Rating 1 metal housing
  - Snap in mounting
  - Battery Backup, (2) AAA 1.5V
  - Operating Temperature range -40°to 155°F
  - 30 Amps
  - Selector switch to determine input voltage between 120-277 VAC, 50/60 Hz
  - Or approved equal

### Receptacles

Install electrical duplex outlets as dictated by NEC and install electrical duplex convenient outlets on all walls along an unbroken floor line every 10'. Locate receptacles 18" to center of box above finished floor, unless noted otherwise on plans.

All receptacles and light switches shall be labeled as follows (Reference Fig. 26-01):

- Black lettering – standard circuits
- Red lettering – Emergency Circuits
- 18pt font
- Printed on 12mm White Label tape
- Label place at vertically at top of face plate, centered horizontally
- Label to indicate the panel and circuit number that feed receptacle

No outlets shall be installed above ceiling. Exceptions should be submitted to UNT Project Manager for university review and approval.

All electrical connections above hard or lay-in ceilings must be hard wired with a disconnect switch.

Outlet boxes are not allowed to be installed back-to-back within wall space.

For use with housekeeping floor maintenance equipment, provide a 20-amp, 120-volt electrical receptacle every 30 feet in corridors, on each stairway landing and close to each exterior door. To the maximum extent possible, circuit these receptacles so that more than one piece of high amperage floor maintenance equipment may be operated simultaneously in each corridor.

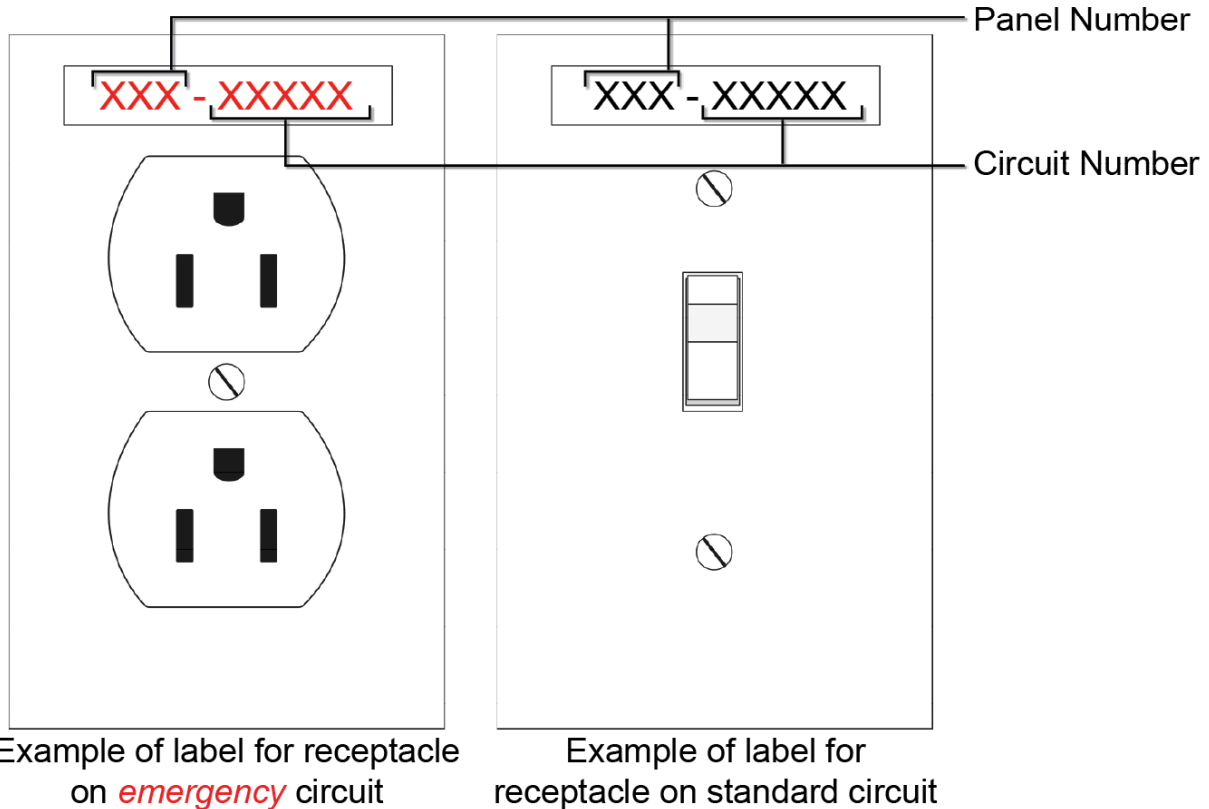

Fig. 26-01

### Electrical Boxes

Metal boxes are to be used for all interior work; no plastic boxes allowed for interior use.

Electrical pull box required every 200' on equal to or less than 600-volt system.

When installing electric outlet boxes in walls and studs, use an electrical box with 2-point adjustable bar hanger bracket to prevent box from floating in wall. Use RACO Steel Adjustable Bar Hanger with one-half inch (1/2") Knockout, Model #920, or approved equal. See Appendix G, Figure 35 for example.

NEMA 3R boxes are to be used for all exterior applications.

### Electrical Breaker Panel and Circuit Identification

In existing building, remodel project design engineer shall continue electrical panel names/number sequences based on existing building panel designations.

All panel schedules shall be updated at the end of any remodel project, or when circuits are added to panels. Updates must be typewritten and placed in front of previously posted panel schedules. Handwritten panel schedules are not acceptable. Panel schedules shall reflect as-built drawings

and electronic copy provided to the owner. Previous panel schedules may not be removed. See Fig. 26-02 for formatting example.

Panels shall include:

- Electrical Contractor name and contact information
- Date of installation
- General Contractor information

All 480/277/208-volt circuits shall be identified at each junction box it passes through on the inside of junction box cover.

All outlet covers shall be labeled with the panel and circuit breaker number it is fed from. See Fig. 26-01

All outlets served by a generator shall be clearly identified with a red outlet or red cover (nylon acceptable).

All panels and outlets on an emergency generator will have a prefix "E", and those on a standby generator will have a prefix "S" on designations.

All general-purpose power circuits will be a minimum of 20 amps.

Switch plates, blank and outlet covers in mechanical rooms, kitchens, restrooms, high traffic hallways, and common areas shall be stainless steel. Heavy duty nylon or unbreakable covers are acceptable in other applications. Plastic is unacceptable.

Dedicated breakers will be sized according to equipment manufacturer's specifications per device.

Where panels are replaced, minimum electrical panel size should always allow for future expansion. Provide next size up panel unless provided services are restricted.

Company Name				
Address				
Phone / Other Contact Info.				
FED FROM				LOCATION
PNL B2			ADMN352	
PANELBOARD				
CIRCUIT		THREE PHASE PH ABC PH		CIRCUIT
	1A		2A	
	3B		4B	
RM 320E	5C		6C	
	7A		8A	OUTLET RM 316B E WALL
RM 316A RM 320E	9B		10B	
	11C		12C	PLUGS W WALL RM 312
COPIER RM 360	13A		14A	PLUGS W WALL 312
RECEPTICAL RM 360C	15B		16B	
	17C		18C	
	41C		42C	
manufacturer website	DATE 5/16/2024			

Fig. 26-02 – Acceptable panel schedule example

26 09 23 Lighting Control

Provide dual level inboard/outboard switching to control lighting in all areas or occupancy sensors as appropriate to the use of the space.

Sensor Switch brand is currently installed and in use on campus, specific models are:

- |                        |   |
|------------------------|---|
| Wall Switch Series     | WSD, WSD-SA, WSD-PDT, WSD-PDT-SA, WSD-2P (2 pole) |
| Corner Wall Series     | WV-16 and WV-BR (bracket)                         |
| Fixture Mounted Series | CMRB-9  |
| Power Packs            | MP-20 and MSP-20                                  |
| Ceiling Sensor Series  | CM-9, CM-10, CMR-9 and CMR-PDT                    |

For areas over 200 square feet, provide multiple switching to reduce the lighting. Use dimmable LED fixtures. Classrooms, lecture halls and conference rooms will have one bulb in each fixture of the back row switched separately from the rest of the room to allow subdued lighting during media presentation. See Appendix G, Figure 34. Specific chalkboard lights will also be switched separately from the rest of the room. Other areas may be so equipped if feasible.

Provide wall-mounted toggle switches for all lighting except exit and night lights. Use dual switching for classrooms, large offices, auditoriums, library stacks and other suitable areas.

Specify programmable control of all building lighting tied in with the campus computer control and monitoring system (CMS) unless shown to be economically undesirable. A manual override shall be provided in the main mechanical room. Provide control capable of remotely reducing lighting levels by 1/2 to 2/3 in all building areas.

## 26 10 00 Medium-Voltage Electrical Distribution

### **Campus Primary Electric Distribution System**

The electrical distribution system serving the campus is operated and maintained by the University. The main campus is served from two substations with two feeds each, forming a loop around campus. Eagle Point campus has one substation and one feed from DME and does not have a loop. Discovery Park campus has one substation and two feeds and a loop in inside the main building. Power is purchased from the City of Denton at the substations. The primary voltage of the campus electric distribution system is 13,200 / 7,620 volts. It is installed primarily in an underground conduit and manhole system.

All new facilities, facility additions and facility modifications requiring new or modified primary electric system service should be served via the underground duct bank and manhole system. All electric facilities associated with the project, such as duct banks, manholes, cable, transformers and associated materials, are included in the project scope.

The electrical designer shall obtain from the University the point of service to the project. Provided the contractor taps into the University's distribution system, the cost of electricity for construction and bringing the building on-line shall be borne by the University. The capacity of the transformer and service conductors from the transformer should provide for the full-connected load plus 25% additional load capacity for future growth.

The design of the electric system for the project should begin at the service delivery point designated by Electric Distribution. The preferred cable size for transformer primary connections is No. 2 copper 15 kV medium voltage cable (EPR insulated). All system connections, medium voltage cable terminations and the medium voltage transformer connections shall be made part of the project by the contractor.

### **Distribution System**

UNT to provide Duct Bank Detail, see Appendix G Figures 39 - 42

Duct Bank shall not run under permanent fixtures and shall be capped with 3 inches of concrete. The concrete used for the cap shall be thoroughly mixed with red dye prior to installation.

All duct banks will have a minimum of 36" of earth cover.

Duct will be Schedule 40 PVC, unless otherwise approved. In runs over 100', designer will evaluate the need for galvanized rigid steel elbows to prevent damage during cable installation. All such elbows shall be large diameter turns.

All ducts will be installed in such a manner to prevent accumulation of water.

Upon completion of duct installation and prior to pulling any cable in duct, a mandrel ½" smaller than the nominal size of duct will be pulled through the duct.

All unused duct will have a nylon or polypropylene pull string installed for future use. The pull string will be Greenlee or equal with a minimum of 240 lbs. tensile strength, and will be rot and mildew resistant. Wire will not be used.

Duct bank penetrations of foundation wall will comply with the following:

1. The conduit will make individual penetrations of the foundation wall.
2. The conduit will penetrate the foundation wall in the following manner:
  - a. For new construction, the foundation wall will have a steel sleeve installed that is 2" larger in diameter than the conduit to be installed. For existing construction, the hole will be core drilled. In multiple duct situations, sufficient space will remain between the penetrations to maintain the structural integrity of the foundation wall.
  - b. A rubber seal, equal to Link-Seal, will be installed in the space between the conduit and the sleeve or drilled hole, near the interior surface of the foundation wall. The same space will have waterproofing installed on the exterior side of the rubber seal.

### Direct Burial Systems

Direct burial systems are not allowed.

### Medium Voltage General

This voltage is considered to be between 601 volts and 69,000 volts.

Splices shall not be used unless approved by owner.

Feeder conductors should have adequate length to allow for future re-work.

Schedule 80 PVC shall be installed at exterior transformer, switch gear and generators.

Arc flash protection is required on all medium voltage cables exposed in manholes or trenches in substations. Arc proofing will be accomplished through the application of tape and binding.

Arc proofing tape will be Irvington #7700 as manufactured by Minnesota Mining & Manufacturing Co., or approved equal, applied in a half lap spiral wind with a tape width suitable for the conductor size as recommended by the manufacturer.

The arc proofing tape will be firmly held in place by a reverse spiral wound fiberglass tape equivalent to Scotch Brand #27.

Medium Voltage Cable

- A. Acceptable Manufacturers:
  - 1. Okonite
  - 2. Prysmian
  - 3. General Cable
- B. Power cable shall be equal to Okonite Okoguard 15 KV, single conductor copper, ethylene propylene rubber insulated, 133% insulation level with copper tape shielding and overall PVC jacket. Cable shall be UL listed as Type MV-105.
- C. Main loop conductors shall be 500kcmil.
- D. Radial feeders serving distribution transformer shall be #2 minimum.
- E. Provide #2 AWG XHHW stranded copper ground conductor minimum in each conduit with phase conductors. This applies to main loop and radial feeders serving distribution transformers.
- F. Submit cable pulling tension and sidewall pressure calculations for each run prior to ordering cable.

Primary Cable Testing

- A. For the dielectric withstand test, utilize very low frequency (VLF) dielectric withstand voltage.
- B. Insulation resistance of each cable shall be measured with a 500-volt megohm meter. Cable will be rejected if resistance is less than 25 megohms.

All testing shall be witnessed by the Owner’s representative.

26 12 00 Transformers

See Specification in Appendix I.

All transformer installations shall comply with the latest edition of the National Electrical Code, Article 450, be of a “less flammable” design using FR3 insulating fluid, and shall be "K" rated.

Transformers, dry or oil-filled, shall be manufactured by Cooper, Square D, or General Electric.

The KVA size of the pad mount transformer(s) on any project should be based on the diversified KVA demand expected on the transformer(s). Over sizing greater than 25% of transformers is discouraged. For metering refer to Uniformat section 25 – Utilities Metering Equipment Guideline Secondary voltages from pad-mount transformers are 208/120 volts Grounded Y and 480/277 volts Grounded Y. High-leg transformers shall not be permitted.

Primary transformers are three phase, radial feed, dead-front pad mount design. Locate pad-mounted transformers at an acceptable site outside the building, at a sufficient distance from any building opening (door, window or loading dock). Do not locate transformers within or on buildings or within closed spaces. Transformers must be accessible to maintenance personnel and truck-mounted cranes. Maintain at least 10 feet clear distance in front of the transformer for access to the primary and secondary compartments. The 10-foot distance is necessary for hot-stick operation of the terminations and cables. Keep the areas above, around and behind of the transformer free of any obstacles that may interfere with transformer removal or installation.



Use significant care to ensure that the transformer pads are adequate for the transformers placed on them. Typical difficulties include: a) inadequate openings for the primary and secondary conduits; b) inadequate primary and secondary compartment sizes (width, depth, height); c) improper location of primary or secondary conduits (conduits do not fit the available openings in the transformers). Seal window of pad to prevent insect and animal intrusion.

### Basic transformer installation

1. All transformer installation shall be properly compacted during installation, and top of pad shall be 8" above final grade.
2. All transformers shall be surrounded by stabilized, crushed, or decomposed granite, 3 ft. clear around oil cooling fins, and 10 ft. in front of doors.
3. Pad-mounted, outdoor transformers with dead-front load break type elbows. Transformer protection will be "bayonet" or current limiting fuses as indicated by fault current. Radial units will be used. Transformers will have taps.
4. Pad mounted outdoor fused air type 600 or 200 ampere switches will feed each radial transformer. The switches will be of the type which allow for loop feed.
5. 10 ft. clear space must be maintained in front of all doors.
6. Transformers and switches will be separate units. All equipment for new or replacement installations will be rated for 15kv operation.
7. All primary cable will be copper with cross-linked ethylene propylene rubber insulation rated 133% and Okonite Okoguard.
8. All primary cable should have adequate length to allow for future re-work.
9. Fusing of transformers will coordinate with the owner's first upstream device. In all transformer installations, especially a retrofit or replacement installation, the secondary system fault current will be analyzed.
10. Metering shall mount on or close to the secondary compartment. The primary meter function is to measure power use and demand. Potential transformers (PT) are for measurement of a secondary voltage. Current transformers (CT) are for measurement of secondary current. PTs and CTs should mount inside the transformer secondary compartment.
11. Ratios for the potential transformers will be determined by the consultant.
12. LVT (Low Voltage Frequency test) is required in lieu of a Hipot test when new cables are pulled to a utility transformer.

### 26 13 00 Switchgear

1. All pad-mounted switch gear will be type PME or Vista, as manufactured by S&C.
2. All pad-mounted switch gear installation shall be properly compacted during installation, and top of pad shall be 8" above final grade.
3. 10 ft. clear space must be maintained in front of all doors, and 3 ft. clear space in front of switch handle compartments.
4. All switch gear and switch gear components must be rated for 25 KA (symm) available fault current and be tested to 25 KA (symm) by an independent testing agency.
5. Pad-mounted or outdoor enclosure mounted switches will have hinged doors suitable for padlocking. Air switches will have the option of key interlocks as required for operating protection.
6. Cable terminations will be for a dead front device. PME fuse holders and fuses will be designed for visual inspection and maintenance accessibility. Switches will be suitable for 600 and 200

ampere feed. Configuration generally will be two loop switches and with one or two fused taps as indicated. Fuse holders will be suitable for a wide range of fuses including current limiting. Vista overcurrent protection shall be programmable from a laptop computer.

7. Due to high fault currents on the medium voltage system, each switch application will require a study of the available fault current at the given location.

### Cable Testing

1. Medium voltage cable shall be tested before energizing. Use the 2009 ANSI/NETA Standard for Acceptance Testing Specifications for Electrical Power Equipment and Systems (ANSI/NETA ATS-2009).
2. The testing procedures are given in Section 7 of ANSI/NETA ATS 2009.
3. For the Dielectric withstand test, the preferred method is very low frequency (VLF) dielectric withstand voltage. Do not use direct current (DC) dielectric withstand voltage greater than 20,000 volts for previously energized cable. Also, limit the time of application of this voltage.
4. All testing will be witnessed by the Owner's representative.
5. LVT (Low Voltage Frequency test) is required in lieu of a Hipot test when new cables are pulled to a utility switchgear.

### Medium Voltage Switches

1. Medium voltage switches shall be mounted on pre-cast pads; thickness to be determined by engineer.
2. All pad-mounted switchgear installation shall be properly compacted during installation, and top of pad shall be 8" above final grade.
3. All pad-mounted switchgear shall be surrounded by stabilized, crushed, or decomposed granite, 3 ft. on sides where switch handles are located, and 10 ft. on sides with doors.

### Fault indicators

1. The electrical system will be equipped with fault indicators so visual inspection can be made to quickly determine what portions of the system had a fault current flowing through them when the system was opened by a circuit breaker or other type of fault current clearing device.
2. The cable fault indicator will show a "fault" indication on all units up through the last indicator just ahead of the fault point on the cable.
3. Fault indicators will be the automatic reset type designed for single phase application.

### Execution

1. All cable installations where the calculated pulling tension exceeds 67% of the manufacturer's recommended maximum tension will be installed using tension measuring equipment. The Owner's representative must be present to observe these installations. These cable runs will be clearly marked on the plans.
2. All cable pulled through wet or damp conduit will be sealed on the end to prevent any moisture from entering the insulation.

## 26 20 00 Low-Voltage Electrical Distribution

### Secondary Circuits General Requirements

1. Conductors shall be copper, no aluminum, and have adequate length to allow for future re-work.

2. Color code secondary service, feeder, and branch circuit conductors with factory applied color as follows:
  - a. 208/120 Volts Black A, Red B, Blue C, White is Neutral, Green is Ground
  - b. 480/277 Volts Brown A, Orange B, Yellow C, White Neutral, Gray/Green Ground

### 26 21 00 Low Voltage Service Entrance

1. At the points where conduit penetrates concrete that is in contact with soil, that conduit will be Schedule 80 PVC conduit bedded in sand.

### 26 23 00 Low Voltage Switchgear

2. Building main switchgear shall be UL 1558 class.
3. Internal busses shall be tin-plated copper.

### 26 24 00 Switchboards and Panelboards

1. Panelboards shall have separate buss connections for neutral and ground. These busses shall be tin-plated copper.
2. Acceptable manufacturers for all switchgear, panelboards, and circuit breakers are Square D and General Electric.

### Low Voltage Feeders

1. All conductors shall be copper.
2. All feeders will have a separate copper grounding conductor installed. In no case will the conduit or raceway be used as the grounding conductor.
3. All conduit sizes and conductor numbers and sizes will be shown on the drawings.
4. All panel-boards will have separate grounding and neutral busses. All grounding and neutral wiring will be terminated on the proper buss.
5. No snap-in breakers will be allowed. Bolt-in type breakers will be used. Square D and GE are acceptable manufacturers.

### Branch Circuits

1. All conductors shall be copper clad wiring. Aluminum wiring is not permitted.
2. All wiring systems will be installed using conduit. Flexible wiring systems can be used to as a means of connection, not to exceed 6 feet in length. No daisy-chaining or through wiring of fixtures is allowed.
3. A separate grounding conductor will be installed. Use of the conduit or raceway is not an acceptable grounding method.
4. All general-purpose power circuits will be a minimum of 20 amps.
5. No piggyback breakers will be allowed.
6. General purpose power circuits in office areas will not have shared neutrals.
7. Conduit will be supported from the building structure. Attachment to other pipes, conduits, ductwork, etc. will not be allowed.
8. Non-metallic conduit or boxes will not be used except in wet locations. In cases where it is used, conduit 2" and smaller will be a minimum of Schedule 80.

9. Conductors carrying more than 150v to ground will not be installed in conduits with conductors carrying less than 150v to ground.
10. Junction box bushings to be used for all low voltage wiring.
11. Anti-short bushings to be used on all MC conduit.
12. Insulated Multi Tap Connectors (Polaris) for electrical connections on motor load and heat load equipment are not allowed. Mechanical Split Bolt connectors are permitted.

### Conduit

1. Where link seals are required, conduit shall be metal rigid or IMC. Once installed rigid to be wrapped on exterior side of building
2. Schedule 40 PVC conduit will be used for all underground electrical. SCH 80 shall be used for all above ground electrical.
3. All conduit installations shall meet current NEC code.
4. Schedule 80 PVC conduit will be utilized anywhere conduit emerges from concrete or where conduit may receive physical abuse. "Rigid and wrapped" conduit is also acceptable when emerging from concrete or where physical abuse is anticipated. Conduit to transition from PVC to rigid where it turns up into concrete or where exposed to damaged. Rigid Schedule 80 to be wrapped where it penetrates through concrete.
5. EMT should not be used outdoors, in wet locations, in floor crawl spaces, or below 5' AFF without prior approval.
6. The minimum conduit size will be  $\frac{3}{4}$ "
7. All conduit connectors shall be steel compression type
8. No horizontal conduit run allowed inside walls
9. All conduits shall be installed parallel and perpendicular to the building.
10. For Feeders, conduit is to be sized at least one size above the NEC requirement of wire being installed or anticipated to be installed, with minimum size to be 1".
11. PVC conduit will be used for underground electric circuits less than 600 volts that are:
12. Under paved areas and areas scheduled to be paved.
13. Next to permanent buildings, under formal planting beds and in extremely high traffic areas that would be difficult to excavate due to regular heavy use.
14. PVC conduit will be Schedule 40 minimum weight and to be designed for electric application with all connection's solvent welded.
15. All metallic fittings will be compression type and shall be water tight.
16. EMT shall be fastened in place at intervals not to exceed (6'). In addition, each EMT run between termination points shall be securely fastened within (12") of each outlet box, junction box, device box, cabinet, conduit body or, other tubing termination.
17. Hangers and supports for equipment, piping, and conduits should be double nitted top and bottom.

### Devices and Motors

1. All receptacles and switches will have a minimum rating of 20 amps and will be commercial grade.
2. Preferred color for receptacles and switches is ivory. Receptacles which comply with ASHRAE 90.1 (2010) shall be green. Other colors may be used to match existing devices or for special uses.
3. In areas requiring to have ground fault interrupting capability, it is preferred GFI receptacles be used rather than GFI breakers.

4. Designer will evaluate the need for steel, nylon or other special types of covers, depending on the usage of the area.
5. The preferred mounting heights, above finished floor, are 48" for switches, and 18" for receptacles.

26 32 00 Packaged Generator Assemblies

Wherever possible, locate emergency generators in weather-protected space contiguous with the building which the generator serves. Duct generator exhaust to discharge remote from any air intake for the building. Emergency generators can be either diesel or natural gas. Natural gas generators will have a gas supply metered separately from the building gas supply. Facilities must approve any generator selection.

26 41 13 Lightning Protection for Structures

All buildings over 75 feet in height shall have a lightning protection system. For all buildings less than 75 feet in height, the Designer shall provide a recommendation regarding the inclusion of a lightning protection system for consideration.

Any equipment added to a structure higher than existing lightning protection and/or added to a building without existing lightning protection shall be installed with lightning protection that is properly grounded. Exceptions will be accepted for projects where a lightning protection professional has been consulted and determined that it is not needed.

26 51 00 Interior Lighting

LED lighting is preferred, and avoid the use of incandescent lighting.

Avoid the use of chandeliers.

The standard specification for interior flat panel LED lighting is as follows:

- RAB, EZPAN FA
  - Field Adjustable wattage
  - Field Adjustable color temperature
  - Dimming
  - Sizes: 1x4, 2x2, or 2x4
  - Finish: White

Luminaire disconnect must be able to pass through knock out hole in make up box.

Lighting should not exceed an average of 1.5 watts per gross square foot. Lighting should not exceed power allowances as determined by the latest IECC code [Section C405.4.2] adopted by the university.

Recommended lighting colors are as follows, with all exceptions to be approved by Campus Architect:

Application	Color
Office	4000K
Classrooms	5000K

Residence Halls	3500K
-----------------	-------

Lighting controls shall be Lutron that work with Graphic Eye Controls.

Use one voltage exclusively throughout a building. Where 480/277V is available use 277 volts for lighting.

### Lighting Fixture Types

1. Ballast configuration should allow for dual level switching, with the exception of fixtures with only 2 bulbs.
2. For general offices and classrooms where dimming is not required, and all other indoor building applications not mentioned in this section, use "general use" lay-in LED fixtures, as mentioned above.
3. Use dimmable LEDs in dimming applications.
4. Remodel and expansion project: match light fixtures found in adjacent areas to the project.
5. Emergency Egress lighting fixtures and Exit signs to be tied into Emergency lighting circuit on building emergency generator. If generator is not present, EXIT lights to be on battery backup.
6. Exit signage shall use LED technology.
7. Lighting fixtures shall not share ballasts.
8. Canned lighting fixtures installed in hard ceilings shall have accessible remote ballasts.
9. All recessed can lights shall be dimmable LED.

### Lighting Level Guidelines

Unless safety and security requirements dictate greater illumination or specific visual tasks require either more or less illumination, lighting designs shall conform to the following guidelines:

Interior Space Type	Lighting Level
Open offices, general use	50 foot-candles
Individual offices	60 foot-candles (maximum) with controls to produce a range of lesser illuminations
Laboratories, drafting rooms, libraries, and similar close-task areas	75 to 100 foot-candles
Classrooms	50 foot-candles
Corridors and stairs	10 foot-candles
Shop areas	30 foot-candles, with task lighting as required
Lobbies and lounges	20 to 30 foot-candles
Emergency lighting	2 foot-candles
Specialized areas	In accordance with recommendations of the Illuminating Engineering Society Lighting Handbook
Conference tables	30 foot-candles with background lighting 12 foot-candles

### Lighting of Large Interior and High-Bay Areas

Type of lighting will be reviewed and approved by Facilities per application. For multiple usage facilities, provide 3 stage switching.

Design for illumination levels as follows:

Interior Space Type	Lighting Level
Warehouse	30-foot candles
General recreation	50-foot candles
Competition areas	75-foot candles
Televised athletic events	100-foot candles

### Lighting of Mechanical Equipment Rooms

Light mechanical equipment rooms with LED fixture lamps at 30 foot-candles. Electrical and control panels shall have task lighting designed at 50 foot-candles. Lighting in mechanical spaces will not be controlled by occupancy sensors or timers.

Locate switches for mechanical room lighting fixtures inside the room and beside the door – large mechanical rooms with more than one door shall have 3-way switches to provide control at each entrance. Place mechanical room lights on emergency circuits from the emergency generator.

### Maintenance Considerations

The lighting design must address accessibility for re-lamping, cleaning and other maintenance procedures. The following guidelines are provided:

1. Do not locate fixtures directly over hazardous chemicals, mechanical equipment and laboratory benches. Install fixtures on the perimeter of such equipment and properly directed.
2. The Designer should make special provisions for solving the maintenance problem associated with lamps located in high ceiling areas.
3. Mount stairwell fixtures so that maintenance personnel can reach them safely from an 8' or shorter ladder.
4. Consider the use of maintenance accessible indirect lighting or LED in stairwells that meets current fire and life safety codes.

### 26 56 00 Exterior Lighting

Lighting constitutes the first line of defense in the overall security and safety plan of the campus. Lighting provides the needed visibility for vehicles, and more importantly, pedestrians to safely travel around the campus.

Lighting typically falls into the following categories: (a) streets, (b) parking lots, (c) walkways, (d) athletic (e) common areas around buildings, (f) Architectural lighting. It is the goal of the University to preserve the ambiance of the campus while ensuring well-lit areas of travel about the campus. This requires the continuity of fixture types and luminaries. The majority of campus is currently lit with high mast lighting. New light poles should be “pedestrian friendly” to achieve a more human scale and characteristic campus lighting. New lighting temperature shall be 5000 Kelvin.

The standard specification for exterior campus pedestrian lighting is as follows:

Hubbell WMA-GL-STL-UNT-CAMSTD-Pulse-CUS14-47LED-5K-BL (or equivalent) color: gloss black, straight round aluminum arm LED 5000K, 48w/LED lamps 120/277v, luminous rings.

One out of every five light poles are required to have a 120-volt GFI outlet.

See Appendix G, Figure 40.

Architectural Lighting (Ground Lighting) shall be 4000 Kelvin in color temperature LED Lighting Fixtures. All Architectural outdoor fixtures shall be operated by a photocell or in the case of multiple circuit lighting fixtures shall be on a contactor that is operated by an Astro Digital Intermatic Control Clock, model # ET8015C, unless controlled by the exterior building lighting system.

Examples of this type of lighting are:

- Wall washer accent lighting
- Landscape lighting
- Campus entrance monument lighting

Note: special theme colored or color-changing lighting systems are an exception to the 4000 Kelvin color temperature.

Bollard lights where 12’ poles are not suitable will have 55w/Magnetic Induction or equal LED lamps. Space bollard lights 12-15 feet apart on-center to achieve 1-5 foot-candle light coverage for pedestrian settings. See Appendix G, Figures 50 and 51.

Parking lot lighting should be LED whenever possible.

Outdoor lighting systems shall be designed to provide the illumination levels in the chart at the end of this section using the following University standard poles and luminaries. New lighting should be Magnetic Induction or LED. Lights in pedestrian walkways, bicycle paths and bicycle rack areas should be 12’ poles with 85w/Magnetic Induction. Lights at roadways and parking lots should be 30’ or 35’ poles with 200-watt Magnetic Induction or equal LED lamps for voltages 277 and below. 480-volt lighting use Cree 267w LED or equivalent. New and/or replacement fixtures shall conform to existing fixtures in and around the general area under consideration and shall be of equal or better quality. An example of an acceptable fixture is Hess America Valencia Series or approved equal. The use of lighting bollards is discouraged. Fixtures should be of the extruded type and represent a minimum maintenance item for the long term. As a minimum, lighting levels should conform to the following:

Location	Min. Foot-candle Level	Average Foot-candle Level
Pedestrian Walkways	1.0	--
Exterior Egress	1.0	--
Bicycle Paths	1.0	--
Bike Racks	1.0	--
Roadways	.25	1.0 to1.5
Parking Lots	.50	Evaluate project specific
Building Entrances	5.0	1.5 times floodlighting design levels if the building has floodlights



All outdoor fixtures shall be photocell relay operated. Multiple lighting fixtures shall be on a contactor that should be operated with photocells tied into EMS campus controls.

All new lighting circuits will be installed in schedule 40 PVC conduit, ¾ inch minimum.

Avoid the use of computer controlled exterior lighting systems.

No external electrical attachments are allowed to connect to light poles, with the exception of outlets and cameras.

Lighting in relationship to a new or remodeled facility may typically involve removal of existing fixtures, addition of new self-standing fixtures and addition of new wall-mounted fixtures.

### Removal of Existing Fixtures

It may be necessary to remove some existing fixtures to facilitate the transition between a new fixture and the existing fixtures, or to improve the lighting level. Removal of all existing fixtures is accomplished by the contractor and delivered to the UNT Facilities, or relocated as specified in the construction documents. Include associated costs for this work within project budgets. There are many fixtures on campus that are very old, and as such, almost impossible to replicate. Exercise great care when handling these fixtures. The preferred electric distribution allows for power to be supplied to all fixtures from the respective building load center. Fixtures may or may not be all on one circuit. Use appropriate breakers and contactors in conjunction with rated photocells.

### Addition of New Free-Standing Fixtures

When the need arises for adding new free-standing fixtures, care should be given to ensure uniformity in fixtures and lighting levels with surrounding fixtures and lighting levels. Detail should be given to all obstructions which result in a "cutoff" of the required light pattern. Electric distribution prefers that power is supplied to all fixtures from the respective building load center.

Each new free-standing fixture needs a unique identifying tag. In order to achieve this, the following procedure will be followed:

1. Contractor to submit the site lighting plan to UNT Facilities via email to [Facilities.GIS@unt.edu](mailto:Facilities.GIS@unt.edu).
2. UNT Facilities GIS will partner with the UNT Facilities Electric Shop Supervisor to assign unique identifiers to each site lighting pole/bollard.
3. UNT Facilities GIS will return the site lighting plan to the Contractor with each light pole/bollard identified.
4. Contractor creates outdoor-rated vinyl labels and installs on each pole/bollard as part of the project's scope of work.

Provide cast-in-place concrete light pole bases. Bases should be embedded no less than 1/3 the height of the pole. Consult with structure engineer for required depth as required.

### Addition of New Wall Mounted Fixtures

Wall-mounted fixtures other than decorative, such as wall-packs are strongly discouraged. When the need arises for mounting fixtures on an outside wall of a building, design the lighting system to ensure adequate lighting levels without creating glare or nuisance lighting in other areas. Mount these lights for ease of maintenance and connect to a source in the building load center. Contact the Project

Manager regarding available voltages and sources, fixture styles, types and placement prior to preliminary design.

### 26 56 13 Lighting Poles and Standards

See Appendix G Figure 40 and Figure 50-51.

## 27 Communications

Refer to Appendix B: Telecommunications and Data communications Standards.

### Telecommunications Ductbanks.

See telecommunications ductbank standard, Appendix G, Figure 46.

No multi-cell products in conduits, only a mule tape in each new conduit.

Maximum amount of bends between manholes to no more than 180 degrees.

Limit duct bank to 400' from manhole to manhole.

Contractor shall cleanout ducts using a solid mandrel and a stiff bristled brush prior to pulling cable; then, install mule tape prior to cable installation.

When cable is installed, always install additional mule tape with tracer wire for locating purposes and future cable installations.

## 28 Electronic Safety and Security

### 28 10 00 Access Control

1. Offline Electronic Locks
  - A. For stand-alone card access systems cylindrical, use CO-100-CY70-KP-SPA-626-BD for keypad only, or CO-200-CY70-MSK-SPA-626-BD for card swipe lock.
  - B. For panic trim/exit devices use CO-100-993R-DP-SPA-626-BD for keypad only, or CO-200-993R-MSK-SPA-626-BD for card swipe lock.
2. Online Electronic Locks
  - A. Use only Von Duprin exit hardware, 99 series or 33 series, no substitutions.
  - B. Von Duprin 914 power supply (4 amp) to power EL kits (1 per pair of EL kits), no substitutions.
  - C. Von Duprin EL kit, no substitutions.
  - D. Schlage MR20 card reader with keypad, no substitutions.
  - E. Schlage IONX8 input/output board, no substitutions.
  - F. Schlage RINX reader interface board, no substitutions.
  - G. Schlage reader controller board, no substitutions.
  - H. Schlage power supply 906-BB8 to power panels/controllers, no substitutions;

- I. UNT prefers concealed Von Duprin EPT2 (electronic power transfer) over armored door loops whenever possible.
- J. If a lever lock is necessary, use AD300-993R-MSK-SPA/ATH-626-643a-BD for hardwired or ADA400-993R-MSK-SPA/ATH-626/643a-BD. The CY70 can be substituted for the 993R if no exit device is used. No other substitutions.
- K. A Schlage PIM485 (wireless hub) will need to accompany the AD400 wireless lock.
- L. Schlage WRI (wireless reader interface) should be used on occasions when running wiring is not possible.

### 28 46 00 Fire Detection and Alarm

The Designer shall comply with all specifications issued by the University of North Texas System Fire Marshall. Contact the University of North Texas System Facilities office to obtain the most current specifications for the fire alarm system.

Refer to Appendix C Fire Protection System Specifications.

The University of North Texas Fire Systems Supervisor must review and approve the design of all fire protection systems.

The University has a Central Alarm Receiving System (CARS) located in the UNT Police Dispatch Office, which is capable of supervising fire, burglary, or other trouble signals from any campus location. All fire alarms should have the provision to transmit an alarm signal, supervisory signal, and trouble signal to this location.

Equip each fire panel with a network card and software to interface with Onyxworks network.

Equip each building with an annunciator panel, per specifications, that will indicate the occurrence and location of any abnormal condition. Such a condition, when occurring, is indicated in the panel by a flashing light identifying the abnormal condition. The annunciator shall identify the following: fire alarms, supervisory alarms, and trouble signals.

Unless existing conditions require it, no conduits to fire alarms should be surface mounted. If existing conditions require surface mounting, consideration should be given to wire mold or raceways.

### 28 46 21 Fire Alarm

1. Acceptable manufacturers for fire alarms systems are Notifier, or approved equal.
  - a. Must be compatible with Onyxworks.
2. Vendor for fire alarms systems must show the ability to respond to requests for service within 24 hours and the ability to supply replacement parts for the system within 48 hours.
3. All fire alarm panels will be equipped with a "walk test" feature. This allows each activating device to be tested without the need to reset the panel after each device is activated.
4. Power expander units external to the FACP are prohibited unless approved by the fire systems manager.
5. If door hold-opens are used, they will be wall-mounted, magnetic type with proper mounting blocking in the wall. Combination door closer/hold-opens will not be used.
6. All pull stations will be key-operated, keyed the same as the building fire alarm panel.

7. Ionization type smoke detectors will not be allowed unless directed by the fire systems manager.
8. All detectors or other activating devices will be installed in locations that are readily accessible for maintenance. Any initiating device installed above a suspended ceiling (i.e., duct smoke detectors) shall have an indicator showing below the ceiling the location of the device, and remote test switch readily accessible for testing and maintenance. Beam detectors will be used in atriums or other high ceiling areas.
9. When fire alarm systems are installed in buildings with elevators, provisions will be included for main or alternate floor recall. Connection between the fire alarm system and the elevator shall be as directed by the fire systems manager.
10. Wiring shall be U.L. listed as fire alarm protection signaling circuit cable per NEC. Wire for digital loops will be a minimum of #18 AWG, twisted pair, shielded type FPL, FPLP, FPLR. Wire for notification circuits will be a minimum #14 AWG, type KF-2 or KFF-2. Alarm speaker wire will be a minimum #14 AWG, shielded type CM. Cable type may vary if recommended by the system manufacturer for compatibility with system warranty or design.
11. All fire alarm system wiring will be concealed in a dedicated raceway, conduit or approved plenum rated wire in J hooks.
12. Ground fire alarm equipment, conductors, and cable shields per NFPA code and manufacturer.
13. Fire alarm audible shall be 10 decibels above ambient noise level. Audio/Visuals will be Wheelock series or approved equal.
14. Fire alarm strobe flash rate to be one flash per second with zero inrush current. Strobes will be Wheelock RSS series or approved equal.
15. Synchronized strobes are required where more than one strobe is visible from any location, including corridors. Where synchronized strobes are used, use appropriate control module based on manufacturer's recommendations, such as Wheelock or approved equal.
16. Alarm speakers will be Wheelock series ET or approved equal.
17. Before partial occupancy, on all fire alarm installations or modification, vendor shall perform all testing with the Fire Systems supervisor. The vendor will provide a copy of the inspections and test forms at the completion of required tests outlined in NFPA.

Fire alarms and other life safety devices must have dust protection installed by the contractor before the start of construction and remain for the duration of work to protect devices from damage. Contractor will be responsible for replacement of damaged life safety devices.

## 32 Exterior Improvements

### 32 12 16 Asphalt Paving

When saw cutting asphalt, wet saw cutting methods are to be used.

### 32 16 23 Sidewalks

All paving repairs shall match existing materials. Exposed aggregate will not be used.

Avoid the use of pavers, including brick, and specifically avoid use of sand set pavers. UNT prefers to use a stamped and colored concrete to mimic pavers and only used minimally for decorative purposes.

Pavers are not allowed at all for driveways and other areas where vehicles will be present.

Brick pavers may be used in select areas of campus by exception only, as approved by campus leadership. Those pavers are required to have lugs or space bars to provide for consistent joints and interlocking. Paver design shall follow the standard detail in Appendix G, Figure 52.

Carefully plan new walkways that connect major destinations and offer pedestrians a safe, accessible and relatively direct means of travel. Indicate these new walkways on the schematic design site plan.

Give special consideration to locations where pedestrian pathways cross vehicular routes. Avoid steps and other features hazardous to the visually impaired. Crosswalks must conform to city of Denton standards. Replace any exposed aggregate sidewalks within project limits. In other situations, mark the pedestrian crossing with generally recognized "cross-walk" stripes on the asphalt-paving surface (see Appendix G, Figure 1).

Maintain consistent walkway widths across the campus. Remove walkways not in use.

The standard walkway widths are:

- Major pedestrian corridors: 16 feet wide
- All other pedestrian sidewalks: 8 feet wide

All sidewalks should be minimum 6" thick with #4 rebar at 12" O.C. both ways over compacted fill and a 2" sand level cushion. Epoxy to be used where rebar is drilled into existing concrete. A minimum of 3" depth for drilled holes.

See Section 03 15 16 for information about control and expansion joint construction.

### 32 17 23 Pavement Markings

1. Streets and City of Denton Right of Ways
  - A. All markings in municipal streets, rights-of-way, or easements must be in accordance with local municipal specifications.
2. Parking Lots
  - A. Fire Lanes
    1. Paint all fire lanes with a red 4-inch-wide stripe with "FIRE LANE- NO PARKING" stenciled in 2-inch white letters spaced at 20-foot intervals within the red stripe.
  - B. Parking Spaces/ Stall Delineation
    1. Parking space indicators will be painted with a White 4" wide stripe.
    2. Parking Spaces/Stalls shall be a minimum of 9' wide and 18' deep unless otherwise noted.
    3. End Caps/No Parking areas
      - a. End Caps/No Parking areas will be painted with a Yellow 4" wide stripe with "NO PARKING"
      - b. Stenciled in 2" Black letters spaced evenly and a maximum of 20" intervals within the yellow stripe.
    4. Handicap Parking Spaces
      - a. H/C Parking Spaces must be marked in accordance with ADA standards or as specified.

5. Directional Arrows
  - a. Directional Arrows will be painted in White. Arrow shafts will be 12" wide and arrow heads to be 18" wide.
6. Painted Curbs
  - a. Painted Curbs in an existing lot must be tested for Lead and removed with proper methods, depending on the composition of the existing paint. If Lead Based Paint is present on any of the coats of paint all paint is to be considered to contain Lead and must be removed with approved methods.
7. Wheel Stops
  - a. Wheel Stops are not to be painted. If parking spaces must be numbered Curb Plaques will be used to identify the spaces. Curb Plaques may be mounted to curbs and wheel stops for identification.
8. Curb Plaques/Signs
  - a. Curb Plaques/Signs will be 3" x 16" and fully adhered to the mounting surface. Color and design must be determined prior to installation by UNT Facilities.

### 32 30 00 Site Improvements

#### **Newspaper Racks and Machines**

When newspaper racks and machines are needed, they should be accommodated within buildings, whenever possible. If it is not feasible to accommodate the racks inside of buildings, group them at entrances to major buildings or other high traffic areas where their location does not interfere with pedestrian movements. Groups of racks should be as inconspicuous as is possible, and should be enclosed on three sides by a screen wall which leaves only enough clearance as may be required for use and servicing.

### 32 31 00 Fences and Gates

The use of metal fencing is generally discouraged and is used only where necessary. Brick walls are preferred, where practical.

When metal fencing is required in visually prominent locations, it should be a decorative metal designed application generally following the standard design with a black finish as shown (See Appendix G, Figure 14). It is also recognized that chain-link fencing may be the only economical alternative in areas away from public view.

### 32 32 00 Retaining and Seating Walls

To prevent skateboard use at railings or walls, use skateboard blocks or nobs at any places identified as potential opportunities for damage from skateboards.

The primary means for providing informal exterior seating is the use of seating walls. Seating walls can accommodate fluctuating volumes of users, require less maintenance and are visually less obtrusive than benches.

Seating walls should be incorporated as part of all courtyard and outdoor space development where the potential desire for seating exists. They should be 16 to 18 inches high and 18 inches wide. They should be constructed of masonry and have generally level tops.

To prevent skateboard use at low walls, use skateboard block or nobs at any places identified as potential opportunities for damage from skateboards.

### 32 33 13 Site Bicycle Racks

Bicycle parking rack can be a 'wave' style galvanized pipe or brushed stainless steel in an "M" or inverted "U" shape in certain applications. Alternative rack style Ground Control Systems Varsity Bike Dock-DV215 or approved substitution. See Appendix G, Figure 13. All new buildings and structures shall include on the final construction and bid documents a budgeted line item for bicycle parking racks. Include bicycle parking racks and parking surface in the bid documents and consider it as part of the construction costs. The number of bicycle racks for new construction is determined in joint consultation with the Project Manager.

Locate each bicycle rack site as close as possible to the perceived destination of the bicyclist (doorways, entranceways, etc.). Use building overhangs and other sheltered locations for bicycle racks, when possible, to afford protection from the elements. Include street curb cuts and ramps for bicycle riding access to buildings and structures. Choose site locations that are accessible by bicycle - avoid paths with outdoor stairways. Bicycle parking sites shall be considered at the schematic design phase, and final site locations determined before the final construction documents are let out for bid.

Every campus bicycle parking rack is to be installed on a paved surface, concrete or asphalt is preferable. See Appendix G, Figure 13 for installation details.

### 32 33 23 Site Trash and Litter Receptacles

#### **Outdoor Solid Waste Collection**

The University is dedicated to maximize efforts to (1) reduce the amount of solid waste the University generates, (2) recycle material recoverable from solid waste originating at university facilities and (3) purchase and use products made wholly or in part from recycled materials.

Depending on the location and type of use, use either:

- Standard Receptacles manufactured by Wabash Valley Manufacturing, Inc. with rib (R) finish. 32-gallon size. Model Number LR300R.
- Solar powered side-by-side Big-Belly waste/recycle bins (specification provided by UNT)

Locate waste receptacles where the need is observed, but keep them visually inconspicuous. Locate receptacles at the intersections of major pedestrian corridors, plaza areas and entries to major student areas. The units should be contiguous to walks and on a paved area extending outward from the walk. The unit should be level and firmly secured to the ground.

Need approval from Project Manager for waste receptacle locations and number of receptacles.

#### **Dumpsters**

Locate dumpsters at major building service areas where their need is observed or anticipated. Locate sites as visually inconspicuous as possible. Gates are preferred when practical. All sites shall accommodate pick-up by a 40 foot long by 8-foot-wide truck, including turn around space. Screen all

sites from public view with constructed elements compatible with the architectural character of adjacent buildings. Landscape planting shall supplement these screens.

Allow a 25-foot clearance above the dumpsters for servicing by dumping truck. Provide a service ramp and pathway to transport service equipment from the building's service door or loading dock to outdoor recycling and solid waste collection site. This service ramp and pathway shall have a minimum width of 6 feet.

When planning a dumpster, refer to Appendix G, Figures 9-11.

### 32 33 43 Site Seating and Tables

The preferred means for providing informal seating are seating walls (see below specification for Seating Walls).

If it is determined that freestanding furniture is necessary for a particular environment, then park benches, tables, trashcans are to be:

- Prestige Single – Pedestal Octagon Tables manufactured by Wabash Valley Manufacturing, Inc. Premium Frame with perforated (P) finish. Model PP202(P)
- Pedestal Octagon Tables manufactured by Wabash Valley Manufacturing, Inc. with perforated (P) finish. Model PP203(P) (Use this table for wheel chair access)
- Bench with back manufactured by Wabash Valley Manufacturing, Inc. with rib (R) finish. 4' Model Number ES401R. 6' Model Number ES420R.
- Swing with Chain manufactured by Wabash Valley Manufacturing, Inc. with rib (R) finish. 6' Model Number SP305R.

### 32 39 13 Metal Bollards

Bollards restrict vehicular movement while allowing pedestrian circulation to continue unimpeded, and are used as a means for filtering vehicular circulation from pedestrians. Removable bollards are used where occasional vehicular access is required.

If it is determined bollards are needed then the campus standard bollard by Reliance Foundry must be used. Fixed bollards are surface mounted and removable bollards have a receiver with a hinged lid. A second receiver should be installed nearby to hold the bollard when it is not in place to restrict traffic.

Standard bollard by Reliance Foundry: (see Appendix G, Figure 12 for installation information)

- Bollard in steel, power coated black on main campus; Model R-7902; Optional powder coat color: anodized silver for Eagle Point Area and Discovery Park.
- Flange mounting kit for fixed bollard; Model R-7900
- Receiver with hinged lid and hardware, stainless steel; Model 7901

The surrounding surfacing material should extend to the base of the bollard. No "new" or different surfacing material is used as a bollard base.

### 32 80 00 Irrigation

#### Part 1 General



1.1 Definitions

- A. Owner: University of North Texas
- B. Architect: Architect or Architect's Representative
- C. Contractor: General Contractor or any sub-contractor responsible for the work specified herein.
- D. Final Acceptance of Installation: This acceptance will be granted upon completion of installation of the complete irrigation system according to the plans and as specified herein. Final Acceptance of Installation will not occur before the Final Inspection.
- E. Final Inspection: The last inspection immediately prior to Final Acceptance of Installation.

1.2 Summary

- A. This section includes labor and materials for the installation of a landscape irrigation system complete in all respects and ready for operation.
- B. Furnish all labor, materials, equipment, transportation, and services necessary to furnish and install the irrigation system complete in place, as shown on the drawings and specifications.
- C. The Contractor shall furnish the articles, equipment, materials, or processes specified by name in the drawings and specifications. No substitution will be allowed without prior written approval by the Owner.
  - 1. Approval of any item, alternate or substitute indicates only that the product or products apparently meet the requirements of the drawings and specifications on the basis of the information or samples submitted.
  - 2. Equipment or materials installed or furnished without prior approval of the Owner may be rejected and the Contractor required removing such materials from the site at his own expense.

1.3 Standards

- A. ASTM D1785 (ANSI B72.7): Standard Specification for Poly (Vinyl Chloride) (PVC) Plastic Pipe, Schedules 40, 80, 120 and Class 200
- B. ASTM D2241 (ANSI B72.2): Standard Specification for Poly (Vinyl Chloride) (PVC) Plastic Pipe (SDR-PR).
- C. ASTM D2466: Standard Specification for Poly (Vinyl Chloride) (PVC) Plastic Pipe Fittings, Schedule 40.
- D. ASTM D2564 (ANSI B72.16): Standard Specification for Solvent Cements for Poly (Vinyl Chloride) (PVC) Plastic Pipe and Fittings.
- E. ASTM D2855 (ANSI K65.55): Standard Recommendation Practice for Making Solvent-Cemented Joints with Poly (Vinyl Chloride) (PVC) Pipe and Fittings.

1.4 Submittals

- A. Contractor's Qualifications: Demonstrated experience on projects of similar characteristics and size.
- B. Licensed Irrigator: Installation of the irrigation system shall be under the supervision of a superintendent or foreman currently licensed as an Irrigator/Irrigation Installer by the State of Texas.
- C. Complete material list shall be submitted prior to performing any work if different from the plans. Material list shall include the manufacturer, model number and description of all materials and equipment to be used.
- D. Record and As-Built Drawings:
  - 1. The Contractor shall provide, and keep up to date, a complete "as-built" set of black or blue line prints which shall be corrected daily and show every change from the original

drawings and specifications and the exact "as-built" locations, sizes, and kinds of equipment. Prints for this purpose may be obtained from the Owner. This set of drawings shall be kept on the site and shall be used only as a working set.

2. These drawings shall also serve as work progress sheets and shall be the basis for measurement and payment for work completed. These drawings shall be available at all times for inspection and shall be kept in a location designated by the Owner. Should these "as-built" progress sheets not be available for review or not be up-to-date at the time of any inspection, it will be assumed that no work is completed.
  3. The Contractor shall make neat and legible notations on the "as-built" progress sheets daily as the work proceeds, showing the work as actually installed. For example, should a piece of equipment be installed in a location that does not match the plan, the Contractor must indicate that equipment has been relocated in a graphic manner so as to match the original symbols as indicated in the irrigation legend. The relocated equipment and dimensions will then be transferred to the original Record plan at the proper time.
  4. After final inspection, but before final acceptance, the Contractor shall submit to the Owner the "as-built" prints. These prints shall be submitted before final payment will be made. With these prints, a color-coded irrigation zone map shall be submitted.
  5. The Contractor shall dimension from two (2) permanent points of reference, building corners, sidewalk, or road intersections, etc., the location of the following items:
    - a. Connections to water lines.
    - b. Connection to electrical power.
    - c. Gate valves.
    - d. Routing or sprinkler pressure lines (dimension maximum. 100 along routing.)
    - e. Sprinkler control valves.
    - f. Routing of control wiring.
    - g. Quick coupling valves.
    - h. Other related equipment as directed by the Owner.
- E. Operation and Maintenance Manuals
1. Prepare and deliver to the Owner within ten calendar days prior to final inspection, one digital copy and two hard cover binders with three rings containing the following information:
    - a. Index sheet stating Contractor's address and telephone number, list of equipment with name and address of local manufacturer's representative.
    - b. Catalog and parts sheets on every material and equipment installed under this contract.
    - c. Complete operating and maintenance instructions on all major equipment.
  2. In addition to the above-mentioned maintenance manuals, provide the Owner with instructions for major equipment.
- F. Equipment to be furnished to the Owner:
1. Two (2) sets of special tools required for removing, disassembling and adjusting each type of irrigation head and valve supplied on this project, including solenoid wrenches.
  2. Two (2) keys for each automatic controller.
  3. Two (2) quick coupler keys with ells.
  4. The above-mentioned equipment shall be turned over to the Owner at the conclusion of the project before final inspection can occur.

### 1.5 Quality Assurance

- A. Manufacturer's directions and detailed drawings shall be followed in all cases where the manufacturers of articles used in this contract furnish directions covering points not shown in the drawings and specifications.
- B. Prior to submittal of bids, Contractor shall acquaint himself with all matters and conditions concerning the site and existing conditions.
- C. Contractor shall be responsible for coordinating his work with the other trades so that all phases of the work may be properly coordinated without delays or damage to any parts of the work.
- D. The Contractor shall be responsible for all sleeves and chases under paving, through walls, etc., unless otherwise noted on the plans.

1.6 Storage

- A. If a storage site is necessary, the Owner will determine the storage site at the Pre-Construction Meeting after the award of the contract.
- B. Contractor shall erect a temporary fence and store material inside of the fenced area.
- C. Contractor shall be fully responsible for the storage site.
- D. Storage at the irrigation site shall not be permitted without written consent of the Owner.
- E. All PVC pipe shall be covered or otherwise protected from ultraviolet light during storage.
- F. Contractor shall maintain the storage area in a neat and orderly manner. If, in the opinion of the Owner, the storage area becomes unsightly, the Contractor shall clean up the storage area within two (2) days of notification.
- G. At the completion of the contract, the Contractor shall remove the temporary storage fence and all debris in the area. The Contractor shall restore the storage area to original condition including, but not limited to, grading and turf re-establishment.

1.7 Public Convenience and Safety

- A. Materials stored about the work shall be so placed and work shall at all times be so conducted as to cause no greater obstruction to the travelling public than is considered necessary by the Owner.
- B. The materials excavated, and the construction materials used in the construction of the work, shall be placed so as not to endanger the work or prevent free access to all fire hydrants, water valves, gas valves, manholes for the telephone, telegraph signal or electric conduits, sprinkler systems, sanitary sewers, and fire alarm or police call boxes in the vicinity.
- C. The Owner reserves the right to remedy any neglect on the part of the Contractor as regards the public convenience and safety which may come to its attention, after twenty-four-hour notice in writing to the Contractor, save in cases of emergency, when it shall have the right to remedy any neglect without notice and, in either case, the cost of such work done by the Owner shall be deducted from the monies due the Contractor.
- D. This project is located on property which could be used by the Public during the course of this agreement. For this reason, the Contractor must observe the utmost care in regards to the Public's safety. Any possible hazards which could result in injury must be eliminated as soon as possible.
- E. No trenches, ditches, etc. shall remain open overnight without approval from the Owner.
- F. Any ditches which are left open must be covered securely so as to prevent any possibility of injury. It shall be the Contractor's responsibility to eliminate any hazards during and after working hours, and the Contractor must have personnel available who can eliminate hazards which are discovered after normal working hours and on the weekends and holidays.

- G. 7. Contractor assumes all responsibility for open trenches, ditches etc.

1.8 Substitutions

- A. If the Contractor wishes to substitute any equipment or materials for the equipment or materials listed on the irrigation drawings and specifications, they may do so by providing the following information to the Owner for approval:
- B. Substitution requests will be considered only after award of the contract.
- C. Substitution requests must be made within 30 days after award of the contract.
- D. Provide a statement indicating the reason for making the substitution. Use a separate sheet of paper for each item to be substituted.
- E. Provide descriptive catalog literature, performance charts, and flow charts for each item to be substituted.
- F. Provide the amount of cost savings if the substituted item is approved.
- G. The Owner shall have the sole responsibility in accepting or rejecting any substituted item as an approved equal to those equipment and materials listed on the irrigation drawings and specifications.
- H. Decisions on substitutions by the Owner are final.

1.9 Changes in the Work

- A. The Owner may, without invalidating the contract, order additional work or alterations to the contract.
- B. Minor changes, such as head locations and controller location, which do not involve extra cost and are consistent with the purpose of the work may be ordered by the Owner and no claim for an addition to the contract sum or time schedule will be considered.
- C. Any changes which affect the contract price shall be requested in writing and the contract sum shall be adjusted. Any extension of time due to additions in work shall be adjusted at the time of the change order.

1.10 Permits and Inspections

- A. In all cases, where inspection of the irrigation system is required and/or where portions of the work are specified to be performed under the direction and/or inspection of the Owner, the Contractor shall notify the Owner at least 24 hours in advance of the time when inspection and/or direction is required, or as specified under "Observation Schedule".
- B. Any necessary re-excavation or alterations to the system needed because of the failure of the Contractor to have the required inspections shall be performed at the Contractor's expense.
- C. Ordinances and Regulations: All local, municipal and state laws, and rules and regulations governing or relating to any portion of this work are hereby incorporated into and made a part of these specifications, and their provisions shall be carried out by the Contractor. Anything contained in these specifications shall not be construed to conflict with any of the above rules and regulations or requirements of the same. However, when these specifications and drawings call for or describe materials, workmanship, or construction of a better quality, higher standard, or larger size than is required by the above rules and regulations, the provisions of the specifications and drawings shall take precedence.

1.11 Final Inspection

- A. A qualified person authorized in writing to represent the Contractor shall be present at the final inspection to demonstrate the system and prove the performance of the equipment.
- B. Prior to the final inspection, all work under this division shall have been completed, tested, balanced and adjusted and in final operation condition.

1.12 Guarantee

- A. Materials and workmanship shall be fully guaranteed for one year after final acceptance. All material will be new and the current production model of the material specified.
- B. Guarantee is limited to repair and replacement of defective materials or workmanship, including repair of backfill settlement.
- C. The Contractor, at their expense, shall repair any defects or replace any defective parts found or occurring during the one-year guarantee period within 48 hours of notification by the.
- D. Manufacturer's warranties shall not relieve the Contractor of their liability under the guarantee. Such warranties shall only supplement the guarantee.

1.13 Measurement and Payment

- A. Work and acceptable material shall be measured as one lump sum. The work performed and materials furnished will be paid for at the contract price. Bid price shall be full compensation for furnishing labor, materials, equipment, and performing operations necessary to install the irrigation system, complete in place, in accordance with the plans and specifications.

Part 2 Products

2.1 General

- A. All materials and accessories shall be of new and unused material. Any section of pipe found to be defective before or after installation shall be replaced with new pipe at the expense of the Contractor.
- B. All new irrigation equipment shall be essentially the standard product of the manufacturer. All new equipment furnished shall have in-service performance records sufficient to verify published capabilities.

2.2 PVC Pressure Main Line Pipe and Fittings

- A. Pressure main line piping shall be PVC Schedule 40, solvent weld joints.
- B. Pipe shall be made from an NSF approved Type I, Grade II, PVC compound conforming to ASTM resin specification D1784. All pipe must meet requirements as set forth in Federal Specification PS-22-70, with an appropriate standard dimension ratio (SDR) (Solvent-weld pipe).
- C. PVC solvent-weld fittings shall be Schedule 40, 1-2, II-I NSF approved conforming to ASTM test procedure D2466.
- D. Solvent cement and primer for PVC solvent-weld pipe and fittings shall be of type and installation methods prescribed by the manufacturer. Primer must be purple IPS Weldon P-68 or approved equal.
- E. All PVC pipe must bear the following markings:
  - 1. Manufacturer's name
  - 2. Nominal pipe size
  - 3. Schedule or class
  - 4. Pressure rating in P.S.I.
  - 5. NSF (National Sanitation Foundation) approval
  - 6. Date of extrusion
- F. All fittings shall bear the manufacturer's name or trademark, material designation, size, applicable I.P.S schedule, and NSF seal of approval.

2.3 PVC Non-Pressure Lateral Line Piping

- A. Non-pressure lateral line piping shall be PVC Schedule 40, solvent-weld joints.

- B. Pipe shall be made from NSF approved, Type I, Grade II PVC compound conforming to ASTM resin specification D1784. All pipe must meet requirements set forth in Federal Specification PS-22-70 with an appropriate standard dimension ratio.
- C. All requirements for non-pressure lateral line pipe and fittings shall be the same as for solvent-weld pressure main line pipe and fittings
- D. Solvent cement and primer for PVC solvent-weld pipe and fittings shall be of type and installation methods prescribed by the manufacturer. Primer must be purple IPS Weldon P-68 or approved equal.

#### 2.4 Ball Valves

- A. Install one ball valve prior to each electric valve location for isolation purposes. Ball Valves shall be of size and type as indicated on the irrigation drawings.

#### 2.5 Quick Coupling Valves

- A. Quick coupling valves shall have a brass two-piece body designed for working pressure of 150 P.S.I. with a 0.75-inch diameter outlet. Key size and type shall match the valve. Rainbird 33DRC with 33DK valve key, or approved equal.

#### 2.6 Backflow Prevention Devices

- A. Backflow prevention units shall be of size and type indicated on the irrigation drawings. Install backflow prevention units in accordance with irrigation construction details and city/state guidelines.

#### 2.7 Control Wiring

- A. Connections between the automatic controllers and the electric control valves shall be made with direct burial copper wire AWG-U.F. 30 volt.
  - 1. In no case shall wire size be less than #14.
  - 2. All electrical work shall conform to code.
- B. Wiring shall occupy the same trench and shall be installed along the same route as pressure supply or lateral lines wherever possible.
  - 1. All wire shall be placed under all pipes in the trench.
  - 2. Where more than one (1) wire is placed in a trench, the wiring shall be taped together at intervals of ten (10) feet.
- C. Pilot wires shall be a different color wire for each automatic controller. Common wires shall be white with a different color stripe for each automatic controller.
- D. Install in accordance with valve manufacturer's specifications and wire chart.
- E. Lay one additional control wire from each controller to the farthest valve in each direction from the controller. This wire control is to be a different color from the other control and common wire.
- F. An expansion curl/coil shall be provided within three (3) feet of each wire connection. Curl must be 10 to 15 wraps around a 0.75-inch pipe. Expansion curl shall be of sufficient length at each splice connection at each electric control, so that in case of repair, the valve bonnet may be brought to the surface without disconnecting the control wire. Control wires shall be laid loosely in trench without stress or stretching of control wire conductors.
  - 1. An expansion curl shall be provided every 125-150 feet along all wire runs.
- G. All splices shall be made with Scotch-Lok #3576 Connector Sealing Packs, Rainbird Snap-Tite wire connector, or approved equal. Use one splice per connector sealing pack.
- H. Limit wire splices between the automatic controller and electrical control valves, locate on "as built" drawings.

#### 2.8 Automatic Controllers

- A. Automatic controllers shall be of size and type shown on the plans. Ground according to manufacturer's directions.
- B. Final location of automatic controllers shall be approved by the Owner.
- C. Install controller pedestal per the manufacturer's instructions.

#### 2.9 Electrical Control Valves

- A. All electric control valves shall be as called for on the plans.
- B. All electric control valves shall have a manual flow adjustment.
- C. Provide and install one control valve box for each electric control valve.
- D. All electric control valves shall not have pressure regulators at the valve, except in the use of drip.

#### 2.10 Control Valve Boxes

- A. Use a 10-inch round box with green overlapping cover for all gate valves, NDS, or approved equal. Extension sleeve shall be used where needed.
- B. Use 12 X 17 valve boxes for valves up to 1 ½"; 17 X 30 for valves 2" and greater with green overlapping cover for all electrical control valves, NDS or approved equal.

#### 2.11 Irrigation Heads

- A. All irrigation heads shall be of the same size, type, and deliver the same rate of precipitation with the diameter (or radius) of throw and discharge as shown on the plans and/or as specified herein.
- B. Spray nozzles shall have a screw adjustment and be manufactured by Rainbird or approved equal.
- C. Riser units from pipe to head shall be a Hunter SJ swing joint or approved equivalent (6" or 12"), unless green cutoff risers are being implemented.
- D. Green cut off risers for all irrigation heads shall be the same size as the riser opening in the body of the head.
- E. All irrigation heads of the same type shall be of the same manufacturer; pop-up spray heads: Rainbird; large turf heads/rotors: Rainbird 5004 series; athletic field turf heads/rotors: Rainbird Falcon 6504 series, Hunter I series (60, 90) or approved equal.
- F. All heads shall be a pressure regulated variant.

### Part 3 Execution

#### 3.1 General

- A. The Contractor shall not willfully install the irrigation system as shown on the drawings when it is obvious in the field that obstructions, grade differences or discrepancies in area dimensions exist that might not have been considered. Such obstructions or differences should be brought to the attention of the Owner. In the event this notification is not performed, the Contractor shall assume full responsibility for any revision necessary.
- B. All work called for on the drawings by notes or details shall be furnished and installed whether or not specifically mentioned in the specifications.
- C. Due to the scale of drawings, it is not possible to indicate all offsets, fittings, etc. which may be required. The Contractor shall carefully investigate the structural and finished conditions affecting all of their work and plan their work accordingly, furnishing such fittings, etc. as may be required to meet such conditions. Drawings are generally diagrammatic and indicative of the work to be installed. The work shall be installed in such a manner as to avoid conflicts between irrigation systems, planting, and architectural features.

- D. Damage to existing irrigation and electrical lines to remain shall be repaired within 24 hours of damage occurrence. If not repaired within the specified time, the Owner has the right to make such repairs as necessary and all costs incurred shall be charged to the Contractor.

### 3.2 Delivery and Handling

- A. Contractor is cautioned to exercise care in handling, loading, unloading, and storing of PVC pipe and fittings.
- B. All PVC pipe shall be transported in a vehicle which allows the length of pipe to lie flat so as not to subject it to undue bending or concentrated external load at any point.
- C. Any section of pipe that has been dented or damaged will be discarded and, if installed, shall be replaced with new piping at the expense of the Contractor.

### 3.3 Preparation

- A. Prior to installation, the Contractor shall stake out all pressure supply lines and valve locations.
- B. All layouts shall be approved by the Owner prior to installation.

### 3.4 Site Conditions

- A. All scaled dimensions are approximate. The Contractor shall check and verify all size dimensions and receive Owner's approval prior to proceeding with work under this section.
- B. Exercise extreme care in excavating and working near existing utilities. Contractor to call Texas811 prior to any digging. Contractor shall be responsible for damages to utilities which are caused by their operations or neglect. Verify existing utilities with the appropriate utility owner.
- C. Damaged utilities shall be repaired by the Contractor the same day they are damaged.
- D. Coordinate installation of irrigation materials including pipe, so there shall be NO interference with utilities or other construction or difficulty in planting trees, shrubs, and ground covers.
- E. The Contractor shall carefully check all grades to satisfy themselves that they may safely proceed before starting work on the irrigation system.

### 3.5 Water Supply

- A. Landscape Irrigation system shall be connected to water supply points of connection as indicated on the drawings.
- B. Contractor shall verify static water pressure prior to commencement of construction/installation. Should there be a discrepancy between the design pressure and the actual pressure, contact the Landscape Architect before proceeding with the work. Failure to do so will result in the Contractor making necessary changes to the irrigation system without additional cost to the Owner.
- C. The Contractor shall provide all required water taps and water meters necessary for the project as indicated on the plans.
- D. Connections shall be made at approximated locations as shown on drawings. Contractor is responsible for minor changes caused by actual site conditions.

### 3.6 Electrical Supply

3.7 Electrical service must be provided to the controllers by the Contractor. The Contractor shall make the final wiring of the controller. Electrical work shall conform to applicable codes.

3.8 Connections shall be made at approximate locations as shown on drawings. Contractor is responsible for minor changes caused by actual site conditions.

### 3.9 Trenching

- A. Dig trenches straight and support pipe continuously on bottom of trench. Lay pipe to an even grade. Trenching excavation shall follow layout indicated on drawings and as noted.



- B. Provide for a minimum of twelve (12) inches cover for all pressure supply lines.
- C. Provide for a minimum cover of six (6) inches for all non-pressure lines.
- D. Provide for a minimum cover of twelve (12) inches for all control wiring.
- E. Install pipe so that writing on pipe can be seen during inspection.
- F. DO NOT trench across the critical root zone of a tree. The only permitted trenching under a tree shall be done in wagon-spoke configuration. Trench using AIR SPADE technology or bore under the critical root zone.

### 3.10 Backfilling

- A. The trenches shall not be backfilled until all required tests are preformed and inspections are made by UNT staff. Partial backfilling between joints is acceptable to prevent pipe from floating. Trenches shall be carefully backfilled with the excavated materials approved for backfilling, consisting of earth, loam, sandy clay, sand, or other approved materials, free from large clods of earth or stones. Backfill shall be mechanically compacted in landscaped areas to a dry density equal to adjacent undisturbed soil in planting areas. Backfill will conform to adjacent grades without dips, sunken areas, humps or other surface irregularities.
- B. Flooding of trenches is an acceptable means of settling soil in the trench.
- C. If settlement occurs and subsequent adjustments in pipe, valves, sprinkler heads, lawn or planting, or other construction are necessary, the Contractor shall make all required adjustments without cost to the Owner.

### 3.11 Trenching and Backfill under Paving

- A. All piping and wiring under existing and proposed paving shall be in appropriately sized sleeves.
- B. Trenches with pipe and wire to be located under areas where paving, asphaltic concrete or concrete will be installed shall be backfilled with sand layer three (3) inches below the pipe and six (6) inches above the pipe) and compacted in layers to 95% compaction, using manual or mechanical tamping devices. Trenches for piping shall be compacted to equal the compaction of the existing adjacent undisturbed soil and shall be left in a firm unyielding condition. All trenches shall be left flush with the adjoining grade. The Contractor shall set in-place, cap, and pressure test all piping under paving.
- C. Generally, piping under existing walks is done by jacking or boring, but where any cutting or breaking of sidewalks and/or concrete is necessary, it shall be done and replaced by the Contractor as a part of the contract cost. Permission to cut or break sidewalks and/or concrete shall be obtained from the Owner.
- D. Provide for a minimum cover of twelve (12) inches between the top of the pipe and the top of pavement for all pressure and non-pressure piping installed under any paving.

### 3.12 Assemblies

- A. Routing irrigation lines as indicated on the drawings is diagrammatic. Install lines (and various assemblies) in such a manner as to conform to the details and plans.
- B. Install NO multiple assemblies in plastic lines. Provide each assembly with its own outlet.
- C. Install all assemblies specified herein in accordance with respective detail. In absence of detail drawings or specifications pertaining to specific items required to complete work, perform such work in accordance with best standard practice with prior approval of Owner.
- D. PVC pipe and fittings shall be thoroughly cleaned of dirt, dust, and moisture before installation. Installation and solvent welding methods shall be as recommended by the pipe and fitting manufacturer.

- E. On PVC to metal connections, the Contractor shall work the metal connections first. Teflon paste shall be used on all threaded PVC to PVC, and on all threaded PVC to metal joints. Light wrench pressure is all that is required. Where threaded PVC connections are required, use threaded PVC adapters into which the pipe may be welded.

#### 3.13 Automatic Controller

- A. Install as per manufacturer's instructions. Remote control valves shall be connected to controller in numerical sequence as shown on the drawings.
- B. 120 Volt wiring for Automatic Controller. Wire controllers per appropriate code. Install liquid tight conduit when wire must be run above the ground.

#### 3.14 Remote Control Valves

- A. Acquire approval from Owner for all valve locations prior to installation. When grouped together, allow at least twenty-four (24) inches between valve boxes. Install each remote-control valve in a separate valve box.

#### 3.15 Flushing of System

- A. After all new irrigation pipe lines and risers are in place and connected, all necessary diversion work has been completed, and prior to installation of irrigation heads, the control valves shall be opened and full head of water used to flush out the system.
- B. Irrigation heads shall be installed only after flushing of the system has been accomplished to the complete satisfaction of the Owner.

#### 3.16 Irrigation Heads

- A. Install the irrigation heads as designated on the drawings.
- B. Spacing of heads shall not exceed the maximum indicated on the drawings and shall achieve head-to-head coverage. In no case shall the spacing exceed the maximum recommended by the manufacturer.
- C. Six (6) inch heads shall be used in installations where St. Augustine and/or Buffalo Grass are present.

#### 3.17 Temporary Repairs

- A. The Owner reserves the right to have made temporary repairs as necessary to keep the irrigation system equipment in operating condition. The exercise of this right by the Owner shall not relieve the Contractor of their responsibilities under the terms of the guarantee as specified herein. Costs incurred from these repairs shall be charged to the Contractor, or withheld from monies due to the Contractor.

#### 3.18 Adjustment of the System

- A. The Contractor shall flush and adjust all irrigation heads for optimum performance and to prevent over spray onto walks, roadways, and buildings.
- B. If it is determined that adjustments in the irrigation equipment will provide proper and more adequate coverage, the Contractor shall make such adjustments. Adjustments may also include changes in nozzle sizes and degrees of arc as required. Any and all changes shall be recorded on the Record Drawings.
- C. All irrigation heads shall be set perpendicular to finished grades unless otherwise designated on the plans.

#### 3.19 Testing of Irrigation System

- A. The Contractor shall request the presence of the Owner in writing at least 48 hours in advance of testing for inspection and witness of test.
- B. Test all pressure lines under hydrostatic pressure at operating pressure, and prove watertight.
  - 1. Testing of pressure mainlines shall occur after installation of electric control valves.

- C. All piping under paved areas shall be tested under hydrostatic pressure at operating pressure and proved watertight.
- D. Sustain pressure in lines for not less than two (2) hours. If leaks develop, replace joints and repeat test until entire system is proven watertight.
- E. All hydrostatic tests shall be made in the presence of the Owner. No pipe shall be backfilled until it has been inspected, tested, and approved in writing. It is permissible to backfill between pipe joints to prevent pipe float. Leave all joints and connections exposed for inspection.
- F. When the irrigation system is completed, perform a coverage test in the presence of the Owner, to determine if the water coverage for planting areas is complete and adequate. Furnish all materials and perform all work required to correct any inadequacies of overage due to deviations from plans, or where the system has been willfully installed as indicated on the drawings when it is obviously inadequate, without bringing this to the attention of the Owner. This test shall be accomplished before any planting takes place.
- G. Upon completion of each phase of work, the entire system shall be tested and adjusted to meet site requirements.
- H. The entire irrigation system shall be under fully automatic operation for a period of seven (7) days prior to any planting.
- I. The Owner reserves the right to waive or shorten the operation period.

3.20 Clean-Up

- A. Clean-up shall be made as each portion of work progresses. Refuse and excess dirt shall be removed from the site and disposed of at the Contractors expense.
- B. At the end of each work day, the Contractor shall leave the site area broom-clean and shall wash down all paved areas within the contract area, leaving the premises in clean condition. All sidewalks, paths, curbs and roads shall be left in a clean, safe condition.
- C. All scars, ruts or other marks in the ground or surrounding area caused by this work shall be repaired to the original condition.

3.21 Final Inspection Prior to Final Acceptance

- A. The Contractor shall operate each system in its entirety for the Owner at time of final inspection. Any items deemed not acceptable by the Owner shall be reworked to the complete satisfaction of the Owner.

3.22 Observation Schedule

- A. Contractor shall be responsible for notifying the Owner in advance for the following observation meetings, according to the time indicated
  - 1. Pressure supply line installation and testing--48 hours
  - 2. Automatic controller installation--48 hours
  - 3. Control wire installation--48 hours
  - 4. Lateral line and head installation--48 hours
  - 5. Coverage test--48 hours
  - 6. Final inspection--7 days

[32 90 00 Planting](#)

## General Design

Design landscaping to be water-saving in nature. Select plants that are native or indigenous to the area that can survive with minimal additional water (with exception of establishment year).

Designs are to draw the eye to various points or flow from point to point and lead to entry/exits and offer exciting visual vistas as pedestrians walk through the campus. Designs are to be interesting and relaxing to the viewer and should complement the building and surrounding landscape. Designs are to include sitting areas – or areas of reflection, quiet or study. Designs are to cascade from the building in stair step fashion – tall, medium and short in order to make the building a part of the landscape and not rigidly separate. Soften all vertical corners whenever possible.

Beds are to be curvilinear in nature and design – no square corners or radius corners.

Designs are to include seasonal native perennial color for interest. Avoid continual 'line of sight/view' obstructions. Occasional tall accent plants are acceptable. For examples see Appendix G, Figures 6 & 7.

## General Installation

1. Plants, locations, bed outline, and bed preparation must be approved by the Owner in writing, prior to beginning planting operations
  - A. Notify the Owner of discrepancies between plant quantities or types indicated on the plans and actual conditions prior to planting
2. Contractor shall verify all underground utilities with the appropriate utility owners.
3. Remove rock or underground obstructions to a depth of 6" below bottom of plant ball or root ball, measured when plant is properly set at the required grade.
  - A. If underground obstructions cannot be removed, notify the Owner for new instructions.
4. Actual planting shall be performed during those periods when weather and soil conditions are suitable and in accordance with locally accepted practice or approved by the Owner.
5. Do not install plant materials when ambient temperature may drop below 35-degree F or above 100 degrees F. Commence landscaping work when the site is free of rocks and debris.
6. Only as many plants as can be planted and watered on that same day shall be distributed in a planting area.
7. Containers shall be opened and plants shall be removed in such a manner that the ball of earth surrounding the roots is not broken. Scarify/loosen/gently cut roots on the outside of the rootball just prior to planting. Plant materials shall be planted and watered as herein specified immediately after removal from the containers. Containers shall not be opened prior to placing the plants in the planting area.
8. Set plants plumb and rigidly braced in position until planting mixture has been tamped solidly around plant material.
9. Thoroughly settle plant by watering and tamping planting mixture.
10. Rake planting beds level before and after planting.
11. Thoroughly water all plant materials after planting.
12. Root ball stake all trees according to the specifications.
13. Protect all areas from excessive soil compaction when trucking plants or other material within the project site.
14. Contractor shall see that all planting areas are free of all weed and foreign material prior to beginning planting.

15. Contractor shall inspect trees, shrubs, and ground cover plants for injury, insect infestation, and trees and shrubs for proper size and shape.
16. Contractor shall not begin planting until deficiencies are corrected or plants replaced. To begin work indicates acceptance of site conditions by Contractor.
17. Obtain written approval from Owner of planting location layouts, and bed preparation prior to installation of trees, shrubs, and ground cover.
18. Dispose of unacceptable or unused soil at an off-site location approved by the Owner.

### Maintenance Until Final Acceptance

The Contractor shall maintain all plant materials from time of planting until final acceptance.

Maintenance shall consist of, but is not limited to:

1. Weeding
2. Watering
3. Pruning (with the consultation of the Owner)
4. Spraying
5. Disease and Insect Control
6. Tightening and Repairing Stakes and Guys
7. Resetting and Straightening Plants
8. Replacement of Unacceptable Materials
9. Mowing of Adjacent Turf Areas (within project site limits)

Tend plant materials as necessary to insure normal, vigorous, healthy growth.

At Final Acceptance, all plant materials and plant areas must be in healthy growing condition, insect free, weed free, pruning complete, and tree staking secure.

### Delivery

1. Deliver all plant materials with legible identification labels
  - a. Label trees, groups of containers of like shrubs, and ground covers.
  - b. State on each label the correct plant name and size indicated on the plant list.
2. Use durable, waterproof labels with water-resistant ink that will remain legible for a minimum of 60 days.
3. Protect plant materials during delivery to prevent damage to root ball or desiccation of leaves.
4. The Contractor shall notify the Owner ten (10) days in advance of delivery of all plant materials.
5. Owner reserves the right to inspect all delivered materials. If determined by the Owner that delivered materials are non-conforming to the plans and specifications, Contractor shall remove the rejected materials immediately from the site.
6. Deliver soil amendments to site and include with the delivery ticket the manufacturer's guaranteed chemical analysis, name, trademark and conformance to state law.

### Storage

1. If a storage site is necessary, the Owner will determine the storage site at the Pre-Construction meeting after the award of the contract.
2. Contractor shall erect a temporary fence and store material inside of the fenced area.
3. Contractor shall be fully responsible for the storage site.

4. Storage at the planting site shall not be permitted without written consent of the Owner.
5. Plant materials will be stored in partial shade and protected from the weather.
6. Contractor shall provide water for irrigating and maintaining stored materials.
7. Any Balled & Burlap (B&B) plants not installed on the same day as delivery shall be heeled in on the day of receipt at storage area to protect them from drying.
  - a. Completely cover the root ball with moist sawdust, bark mulch, wood chips, peat moss, or other similar material, and cover until planted. The B&B plants shall be immediately watered in and kept moist until planting.
  - b. No B & B material shall be left with the root ball not heeled in for more than twelve (12) consecutive hours. Such plants shall be rejected, removed from the site, and replaced at the Contractor's expense.
8. All stored plant materials shall be maintained by the Contractor in a healthy, vigorous condition until planting.
9. The Contractor shall maintain the storage area in a neat and orderly manner. If, in the opinion of the Owner, the storage area becomes unsightly, the Contractor shall clean up the storage area within two (2) days of notification.
10. At the completion of the contract, the Contractor shall remove the temporary storage fence and all debris in the area. The Contractor shall restore the storage area to original condition including, if necessary, grading and turf re-establishment.

### Guarantee

1. The Contractor shall guarantee the plant materials for a period of one (1) year after final acceptance. Replace all dead or defective plant materials not in vigorous, thriving condition within two (2) weeks after notification from Owner. Plant materials which have partially died so that shape, size, or symmetry has been damaged shall be considered subject to replacement. Rejection of plant materials by the Owner shall be final.
2. Contractor shall replace plant material with same kind and size as originally planted at no cost to the Owner. Repair any damage, including ruts in turf or bed areas, incurred in making replacement. Provide one year warranty on replacement plants.
3. Replacement Quantities: Contractor shall be held responsible for a maximum of two (2) replacements for each failed tree and shrub, and same area of groundcover planting after final acceptance during the warranty period.
4. At the direction of the Owner, plant material may be replanted at the start of the next planting season. In such cases, remove dead plant materials within one (1) week of notification from the Owner.
5. Guarantee after final acceptance excludes replacement of plant materials because of injury by storms, drowning, drought, hail, freeze, insects, diseases, mechanical injury by humans or machines, and theft.
6. Plants shall be guaranteed to be true to species, variety or cultivar as specified.

### 32 91 13 Soil Preparation

#### *Topsoil*

1. Screened sandy loam from a source approved by the Owner, 100% passing through a 1" screen and 95% passing through a 2mm sieve.
  - a. Sand (2.00mm to 0.50mm) 40%-50%
  - b. Silt (0.050mm to 0.005mm) 30%-40%

- c. Clay (0.005mm and smaller) 10%-30%
  - d. pH ranges from 6.5 to 8.0
2. Free of subsoil, brush, stumps, roots, organic litter, objectionable weed, clods, shale, stones 1" diameter and larger, extraneous or toxic substances harmful to plant growth.
3. Presence of vegetative parts of Bermuda grass, Johnson grass, nut grass (Cyperus Rotundus), and other hard to eradicate weeds or grass will be cause for rejection of topsoil. Topsoil found to be bearing these materials which has been incorporated into planting site shall cause all of the soil from that part of the site to be removed and replaced at the Contractor's expense with soil mix meeting specifications.
4. In order to ensure conformance, samples of the import topsoil shall be submitted by the Owner, after award of the contract, to a laboratory for analysis prior to and following backfilling. Contractor shall make available to the Owner information regarding time and location at which topsoil will be available for sampling. Cost of testing soil samples not meeting specifications shall be paid by the Contractor.

#### *Pre-Plant Weed Control*

1. If live perennial weeds exist on site at the beginning of work, spray with a non-selective systemic contact herbicide as recommended and applied by an approved licensed landscape pesticide applicator. Leave sprayed plants intact for at least fifteen (15) days to allow systemic kill. Apply herbicide in strict accordance with manufacturer's instructions.
2. Clear and remove these existing weeds by scraping or grubbing off all plant parts at least 1" below the surface of the soil over the entire area to be planted.

#### *Backfill for Shrub and Ground Cover Beds*

1. Remove existing soil to an overall depth equal to ten (10) inches below finish grade.
2. Till exposed soil to a minimum depth of six (6) inches.
3. Add three (3) inches of expanded shale and rototill to a depth of six (6) inches.
4. Add three (3) inches of pH balanced compost and rototill to a depth of six inches.
5. Mulch all planting areas when plant installation is complete with a minimum settled depth of three (3) inches of composted shredded hardwood mulch.
6. Notify Owner for soil inspection after initial excavation and prior to loosening the exposed soil.
7. At time of planting, all areas to be planted shall be free of stones, stumps, or other deleterious matter 1" in diameter or larger and shall be free from all wire, plaster or similar objects including construction debris that would be a hindrance to planting or maintenance.

#### **32 91 13.16 Mulching**

Coarsely shredded decomposed (heat sterilized) hardwood mulch with frayed edges. No soft green or unprocessed materials allowed. Jemasco or Soil Building Systems mulch is acceptable or equivalent as approved by Owner.

1. Cover watering basins and/or planting beds evenly with a layer mulch a minimum of 3" deep. Do not place mulch within 3" - 6" of tree trunks or within 2" of shrub crowns.
2. If the plans designate areas on slopes to receive erosion control netting, do not mulch.
3. Water immediately after mulching.
4. Hose down planting area with a fine spray to wash mulch off leaves of plants.

### 32 91 13.26 Planting Beds

1. Stake outline of planting beds on ground.
2. Place shrubs and ground cover in indicated locations.
3. Shrubs and ground covers shall be planted at the on-center spacing distances specified. Except where the design indicates single rows of plants, all shrubs and ground covers shall be planted on triangular spacing.
4. Plant in pits six (6) inches greater in diameter than root balls or container diameter.
5. Score rootball vertically at four (4) equal points around the edge prior to planting.
6. All plants shall be planted upright, except where instructed otherwise, and faced to give the best appearance or relationship to adjacent plants or structures.
7. Plants shall be placed in the center of each hole and set plumb. The root ball shall stand, after settlement, 1" higher than it originally grew. Plants planted either too deep or too shallow shall be reset at the proper depth by the Contractor at his expense. Plants which are damaged by the resetting operation shall be replaced at Contractor's expense.
8. On B&B shrubs, cut and remove all binder rope, twine, burlap or wire from around the shrub crown to the bottom of the root ball. B&B shrubs shall not be moved, turned or picked up after the binding rope and burlap have been cut.
9. Planting holes shall be backfilled with approved soil. Backfill shall be carefully compacted so as to avoid injury to the roots while filling all voids.
10. All shrub and ground cover planting areas shall be thoroughly watered immediately after planting so that the soil is moistened to the full depth of the root ball. After settling, plants shall be checked for proper planting depth and soil mix added to bring any low areas to proper level.
11. After planting, soil in the shrub/ground cover beds between the plants shall be cultivated and raked smooth and level.
12. Mulch the entire bed with a 3" settled layer of shredded hardwood bark mulch. Keep mulch approximately 2" away from plant crowns to avoid rot. Rake mulch layer smooth.

### 32 91 19 Landscape Grading

1. Contractor shall verify that established grades are correct.
2. Minor modification to grade may be required to establish the final grade.
3. Fine grading shall insure proper drainage of the site as determined by the Owner.
4. All areas shall be fine graded so that finished grades will be a minimum 1" in lawn areas and 2" in shrub and ground cover areas, below adjacent paved areas, sidewalks, headers, cleanouts, drains, manholes, etc. or as indicated on the plans.
5. Surface drainage shall be away from all building foundations at a 2% minimum for 5' minimum.
6. All erosion scars shall be filled and compacted prior to planting installation.
7. Disposal of any unacceptable or excess soil shall be done at a location approved by the Owner at the expense of the Contractor within 48 hours of notification by the Owner.

### 32 92 23 Sodding

#### *Sod Material*

1. Species: Tif 419 for areas with at least 6 hours of full sun. St Augustine for areas under 6 hours of full sun.
2. Do not over seed sod. Provide certification ticket from grower at time of delivery.



3. A minimum of 90% of the plants in cut sod shall be species as specified. The sod shall be free of weeds or undesirable foreign plants, large stones, roots, or other materials that might be detrimental to the development of the sod or to future maintenance.
4. Cut sod with approved machine sod cutters and shall have a uniform soil thickness of  $\frac{3}{4}$  inch.
5. Cut sod into 12" x 24" rectangles or rolled sod as approved by the Owner.
6. Sod shall be uniform in color, leaf texture, and shoot density, and shall be in healthy vigorous growing conditions, free of diseases and insects.

#### *Fertilizer*

1. 3-1-2 ratio multipurpose organic fertilizer, or approved equal.
2. The fertilizer shall be delivered to the site in bags or other convenient containers, each fully labeled, conforming to the applicable state fertilizer laws, and bearing the name, trade name or trademark, and warranty of the producer.

#### *Import Topsoil*

1. Friable, fertile, dark screened sandy loam from a source approved by the Owner, 100% passing through a 1" screen and 95% passing through a 2mm sieve.
2. Sand (2.00mm to 0.50mm) 40%-50%
3. Silt (0.050mm to 0.005mm) 30%-40%
4. Clay (0.005mm and smaller) 10%-30%
5. pH ranges from 6.5 to 8.0
6. Free of subsoil, brush, stumps, roots, organic litter, objectionable weed, clods, shale, stones 1" diameter and larger, extraneous or toxic substances harmful to plant growth.
7. Presence of vegetative parts of Common Bermuda grass, Johnson grass, nut grass (Cyprus Rotundus), and other hard to eradicate weeds or grass will be cause for rejection of topsoil.
8. The presence of any of the above-mentioned materials shall cause the topsoil to be rejected and immediately removed from the site. Topsoil found to be bearing these materials which has been incorporated into planting site shall cause all of the soil from that part of the site to be removed and replaced at the Contractor's expense with soil mix meeting specifications.
9. After the award of the contract, the Owner reserves the right to submit samples of the topsoil to a laboratory for analysis prior to and following backfilling. Contractor shall make available to the Owner information regarding time and location at which topsoil will be available for sampling. Cost of testing soil samples not meeting specifications shall be paid by the Contractor.

#### *Soil Preparation*

1. Eradicate all vegetative materials from the areas to be sodded. The area shall be weed free for a minimum of two weeks prior to completing the soil preparation and sod planting.
2. All areas to be sodded shall be tilled a minimum of 6", raked to true lines and grades, free from all slight grade variations, bumps, ridges and depressions in soil surface. All sticks, stones, roots, clay clods or other objectionable material over 1 inch in diameter which might interfere with the formation of a finely pulverized soil bed shall be removed from the soil prior to raking and planting. Soil is to be loose and friable, not compacted.
3. Once subsoil has been de-compacted and objectionable material 1" and greater removed, add a minimum depth of 4" settled depth of topsoil to loose and friable subsoil prior to placing the sod.

*Inspection*

1. Contractor shall verify that preceding work affecting subsoil scarification is complete. Request inspection by UNT System Landscape Architect or UNT Ground Manager prior to placing topsoil.
2. Contractor shall verify that soil is within allowable range of moisture content.
3. Contractor shall see that the soil is free of weeds and foreign material immediately before sod application. Remove objectionable material which is larger than 1 inch in diameter and remove from the site. Request inspection by UNT System Landscape Architect or UNT Ground Manager prior to placing sod.

*Fertilizer Application*

1. Apply a 3-1-2 ratio multipurpose fertilizer or approved equal after placing sod.
2. Sod shall be moist and shall be placed on a moist soil bed.
3. Sod shall be harvested, delivered and transplanted within a period of 24 hours unless a suitable preservation method is approved prior to delivery. Sod not transplanted within this period shall be inspected and approved the Owner prior to its installation.
4. Sod shall be planted end to end, in a running bond pattern, solid over the areas to accept sod as delineated on the plans, firmly pressed into the prepared topsoil with tight/no gap joints between sod pieces. Gaps that develop between sod pieces will be filled with a suitable top-dressing material.
5. When roll sod is used, remove netting material prior to placing sod.
6. Upon completion of sodding each contiguous area, the entire area shall be watered in until the soil beneath the sod is moist and then hand rolled with a roller weighing at least 80 lbs. but no more than 100 lbs. All uneven or lumpy areas shall be flattened to a uniform level before the installation will be accepted.
7. No area smaller than one (1) square foot shall be planted with more than three individual trimmed sections of sod and no individual section shall be smaller than six (6) square inches.
8. The top of sod soil shall be 1/2" below adjacent paving/hard surface.

*Sod Establishment*

1. Watering
  - a. Keep sod moist from the time of its placement until final acceptance of the entire project, and its continued growth is assured.
3. Water in a manner that will prevent erosion.
4. Mowing/Edging
  - a. Contractor shall be required to mow the sodded areas as needed, minimum 1x/week, from time of application until final acceptance of entire project.
  - b. When sod reaches 3 inches in height, mow to 2 to 2 1/2 inches in height.
5. Do not cut off more than 30% of grass leaf in single mowing.
6. Remove grass clippings and dispose of off-site.
7. Edge as necessary to maintain adjacent edge.
8. Weeding: Sod to remain weed free from time of installation to final acceptance.
9. Any areas that become gullied or otherwise damaged, or any areas of sod that fail to become established satisfactorily, according to the Owner, shall be repaired and/or replaced at the Contractor's expense.

## 32 93 00 Plants

### *Plant Materials*

1. All plants shall have a habit of growth which is normal for the species and cultivar and shall be sound, healthy, vigorous, full, well branched and well formed.
2. Plant materials shall be free of disease or prior disease damage, sun scald, windburn, abrasion, harmful insects or insect eggs, prior insect damage, knots, fresh abrasions of the bark, and other objectionable disfigurements.
3. Tree trunks shall be sturdy, single leader, straight, free of weak crotches, scars, dead wood, crossed or broken branches and mistletoe infestation.
4. Plant materials shall have well "hardened" systems and vigorous and fibrous root systems which are not root or pot bound.
5. In the event of disagreement as to the condition of the root system, the root systems of the plants will be determined by removal of earth from the roots of no less than two (2) plants nor more than two percent (2%) of the total number of plants of each species or variety. Where container grown plants are from several sources, the roots of not less than two (2) plants of each species or variety from each source will be inspected.
6. In case the sample plants inspected are found to be defective, the Owner reserves the right to reject the entire lot or lots of plant materials represented by the defective samples.
7. Plants shall bear label from the grower certifying genus and species. Labels should be securely attached and waterproof bearing legible designation of botanical and common name.
8. Any plant materials rendered unsuitable for planting because of this inspection will be considered as samples and will be provided at the Contractor's expense.
9. All plant materials shall equal or exceed the minimum measurements specified in the plant list. They shall be measured with the branches in normal positions before any pruning is done. Plant materials of the same variety used in a single project shall be of a uniform size.
10. Plant materials larger than specified in the plant list may be used if approved by the Owner but use of such plant materials shall not increase the contract price. If larger plant materials are approved, the root ball shall be increased in proportion to the size of the plant according to the American Standard for Nursery Stock.
11. All plant material not conforming to the requirements herein specified shall be considered defective and such plant material, whether in place or not, shall be marked rejected and immediately removed from the site and replaced with new plant material at the Contractor's expense.
12. At no time shall plant material be pruned, trimmed or topped prior to delivery and any alteration of their shape shall be conducted only with the approval and when in the presence of the Owner.
13. Plant materials designated B & B in the plant list shall be balled and burlapped with the root ball sizes and ratios conforming to the American Standard for Nursery Stock. They shall be dug with firm natural balls of soil for full recovery for the plant. Root balls shall be firmly wrapped with burlap or similar biodegradable material and bound with twine or wire mesh.
14. Container grown plants shall have sufficient root growth throughout the root ball to hold the soil intact when removed from containers, but shall not be root bound. They shall have been grown in the containers in which they are received for a period of no less than 6 months and no more than two years with the exception of large container grown shrubs, small ornamental trees or specimen plants in 20 gallon or larger containers. Plants designated as container grown shall have been produced from seedlings, bare root whips or rooted cuttings which were originally potted into containers and have never been field grown. Containerized plants (B&Bs

which have been dug, placed into a container and grown on) will not be acceptable as a substitute for container grown plants.

15. Ground covers shall be established and well-rooted, and shall have sufficient roots throughout the root ball to hold the soil intact after removal from the pot without being root bound. Plants shall have runners meeting the minimum requirements for number and length as listed in ANSI Z60.1-2004. Species which are not listed there shall have minimum requirements stated in the Plant List. If discrepancies exist between the minimum sizes specified in the Plant List and in the ANSI list, the larger sizes shall be considered the minimum.
16. Plants meeting the requirements specified in the Plant List but not possessing a normal balance between height and spread according to the American Standard for Nursery Stock will be rejected.
17. All plants shall have been grown or acclimatized under climatic conditions similar to those in the locality of the project.
18. B&B plants shall be dug and prepared for shipment in a manner that will not cause damage to future development after planting. Loose, off-centered, or flattened root balls will not be accepted. No plant shall be bound with wire, rope or other material at any time so as to damage the bark, break the branches or destroy the plant's natural shape.
19. Root balls of all plant materials are to be free of established weeds including but not limited to briars, bindweed, poison ivy, poison oak, nut sedge, dallis grass and Johnson grass.
20. Plant material shall be true to botanical and common name and variety. Deciduous plant materials found to be not true in name and variety after leafing out stage or blooming time will be rejected by the Owner and replaced with the proper plant material at the Contractor's expense.
21. Any plant material failing to meet all applicable specifications as outlined shall be rejected and removed from the planting site and/or storage area within 5 days after rejection by the Owner.
22. All plant material shall be nursery grown stock except as noted on the plans or as approved in writing by the Owner. If required, provide proof that material was nursery grown. All rejected stock shall be replaced at Contractor's expense.
23. Trees with a specified trunk caliper of 3 inches or greater shall not branch less than 4 feet above finish grade unless specified as multi-trunk.
24. Any plant materials grown in "grow bags" shall have the bags removed before planting.
25. B&B materials shall have all wire, twine, burlap removed to the bottom of the root ball prior to backfill.

#### *Approved Plant List*

These plants have been successful and thrive on the UNT Denton Campus. We welcome proposals for other plants that have a consistent record of success in North Texas.

#### Perennials

- Lamb's ear
- Holly Fern
- Wood Fern
- Autumn Fern
- Blackeyed Susan
- Purple Coneflower
- Lantana

- Turk's Cap
- May Night Salvia
- Dwarf Mexican Petunia
- Salvia Greggii
- Mexican Bush Sage
- Victoria Blue Salvia

Groundcovers

- Liriope
- Mondo Grass
- Dwarf Mondo Grass
- Asian Jasmine
- Purple Winter Creeper

Ornamental Grasses

- Muhly Grass
- Giant Liriope
- Berkley Sedge
- Carex
- Maiden Grass
- Mexican Feather Grass

Shrubs

- American Beautyberry
- Red Yucca
- Oak Leaf Hydrangea
- Dwarf Yaupon Holly
- Indian Hawthorn
- Rosemary
- Soft Leaf Yucca
- Viburnum
- Nandina
- Abelia
- Nelly Stevens Holly
- Dwarf Burford Holly
- Texas Sage (full sun only)
- Wintergreen Boxwood
- Lorapadalum
- Wax leaf Ligustrum
- Sunshine Ligustrum

Shade Trees

- Sawtooth Oak
- Bur Oak
- Chinkapin Oak

- Red Oak
- Live Oak
- Bald Cypress
- Cedar Elm
- Lacebark/Allee Elm

Lawn Grasses

- 419 Bermuda
- Zoysiagrass (Palisades)
- St Augustine

Small/Medium Trees

- Texas Redbud
- Desert Willow
- Yaupon Holly
- Crapemyrtle
- Possumhaw Holly
- Wax Myrtle
- Mexican Plum
- Mexican Buckeye
- Vitex
- Japanese Maple (morning sun only)

**32 93 43 Trees**

UNT will only accept Balled and Burlap trees (B&B).

Stake newly planted trees with 2 – 6-foot metal t-posts, wire and rubber hose. Perform percolation test on each tree hole to verify water drainage. Test to be filled and 24 hours later reviewed to determine water retention. If water is retained, determine why and make adjustments to site or provide the ability to drain the excess water.

*Execution*

1. Stake locations of trees.
  - a. Use Below Grade Nail Stake ([www.treestakesolution.com](http://www.treestakesolution.com)) or approved equal.
2. Dig a square hole three times (x3) the width of the ball (minimum) and 1 inch short of the height of the ball.
3. Amend the removed soil with one-quarter (1/4) by volume compost or other accepted amendments.
4. Place in center of pit, set plumb with best, most full side to the front of the bed where such a front exists.
5. Root ball shall stand, after settlement, at the same depth at which it originally grew or maximum 2" above finish grade.
  - a. Materials planted either too deep or too shallow shall be reset to proper depth. Loose or broken root balls due to resetting shall be replaced at Contractor's expense.
6. The pit shall be backfilled halfway with specified soil mix, the soil tamped down and watered in to settle the backfill.

7. Cut and remove all binder rope, twine, and wire from around the trunk to the bottom of the root ball.
8. Tree shall not be moved, turned or picked up after the binding rope and burlap has been cut and removed.
9. Stake newly planted trees with two 6-foot metal T-posts, wire and rubber hose.
10. Use amended backfill soil to construct an earthen watering basin around each tree. Basin shall hold 5" of water above finish grade and shall be constructed just around the outside diameter of the planting pit.
11. Each tree shall be watered with enough water to fill the basin and left to soak into the ground.
12. Mulch each tree with a 3" layer of mulch within the water basin, keep mulch 3" 6" from the base of the trunk.
13. Construct watering basins around all newly planted trees.
14. Perform percolation test on each tree hole to verify water drainage. Test to be filled and 24 hours later reviewed to determine water retention. If water is retained, determine why and make adjustments to site or provide the ability to drain the excess water.

#### *Pruning and Repair*

1. After planting, trees shall be pruned and injuries repaired.
2. Other than collected B & B materials, the amount of pruning shall be limited to the minimum necessary to remove dead, damaged or conflicting branches.
3. Do not prune evergreens, except to remove injured branches.
4. All cuts shall be made just outside the natural growth collar at the base of the branch where it emerges from an adjacent trunk or branch.
5. Typical growth habit of each plant shall be retained as much as possible.
6. All cuts larger than 3/4" in diameter shall be trimmed back to healthy tissue if needed, smoothed so as not to retain water and painted with tar base tree pruning paint.
7. All pruned materials shall be removed from the site daily.

#### **32 94 13 Landscape Edging**

Four inches by 3/16 inch, (heavy gauge) with stakes as approved by the Owner.

### **33 Utilities**

The University's Facilities Maintenance Department operates the fire protection systems, electrical, heating water and chilled water-cooling distribution systems serving the main Denton Campus, Discovery Park, and the Athletics Campus. Contractors will not shut down or restore any of the above-mentioned utilities. All changes in university utilities will be coordinated through the UNT Project Manager.

Telephone service is coordinated through the UNT service provider that owns the lines to the Main Distribution Room (MDR) in each building. The Contractor installs as part of the general construction, and the University then owns the twisted pair wiring to each outlet. GTE will run wires to the jumper boards in the MDR, the Contractor runs the wires from the jumper boards to the outlet and the University's Telecommunication office makes the jumper board cross connects. The Contractor should contact GTE directly for Contractor's telephone service during construction.

Water and sewer service is provided by the local municipality. The Contractor shall contact the municipality to establish water and sewer services.

### Temporary Interruptions of Utilities and Traffic Movement

Procedures for making temporary disruptions to existing utilities, roads or pedestrian walks shall be planned well in advance of the work, and the work shall be executed in a manner to provide reasonably continuous service throughout the construction period. Connections to existing utilities are made only at times approved by the University. The University typically schedules interruption of services at times other than the Contractor's normal working hours. Only designated University personnel are authorized to interrupt services. Frequently, outages are scheduled to reduce disruption of classes and special events.

For interruption of service in major utility systems, the Contractor must submit to the Construction Manager a step-by-step sequence of operations planned to accomplish the work. This outline must show tentative dates and times of day for shut-off and restoration of services. Upon approval of the planned operations, the Construction Manager shall make arrangements with appropriate University personnel for interruption of services.

Road and sidewalk cuts shall be scheduled in advance, and made only after they have been approved by the University and the City of Denton in the case of city streets. Contractors shall plan and coordinate their work to minimize the duration of such disruptions. Appropriate detours shall be planned, subject to the approval of the University, giving consideration to the handicapped. The Contractor shall install warning barricades and signs as well as informational signs indicating detours. No service disruptions or excavations are permitted until barricades and signs are in place to protect the public. If the nature of the site does not allow placement of barricades prior to the excavations, the barricade materials must be physically present on site before excavation begins, in order that they may be erected as soon as possible.

### Site Utilities

Underground utilities and other structures shall be designed so that the installation will prevent or minimize damage to existing landscape plants and trees. Do not trench under the drip line of any campus tree, seek alternate design criteria. If a trench must occur, utilize boring or AIR SPADE technology as discussed in the Campus Design section of the Design chapter.

Installation of an irrigation system meter and tap generates a City of Denton connection fee that the Designer/Contractor is responsible for.

For maintenance, repair, or improvement work to existing utilities, the Contractor is responsible for conducting due diligence to verify that the existing utility is operable and in good working condition prior to repair work or making new connections, and shall provide evidence of the operable conditions. The Contractor shall report inoperable utilities to the Project Manager.

### Water and Sanitary Sewer Service

Water and sanitary sewer services to buildings on the campus are provided and maintained by UNT from the building to the meters, which are owned and maintained by the City of Denton. All water and sewer lines must be constructed in accordance with City of Denton Standards and Specifications.



Denton water/sewer tap and impact fees for new connections to existing water or sewer mains will apply to all new University projects. However, the Designer must confirm this determination for each specific project. On projects where these fees do apply, the Designer shall make appropriate provision for these fees, which include the water/sewer service fees, tap/meter installation fees and all other applicable fees, in the project development budget, either by allowances in the construction contract or by reserving funds outside of the construction contracts which is the preferred method. Public sewer mains must be ductile iron. Any existing sewer mains that would fall within the footprint of a new building must be relocated outside the building footprint.

Meter, switch and transformer location

Gas meters, electrical switches and transformer locations shall be thoroughly coordinated with site conditions including existing trees, sidewalks and other restrictions. Locate in an inconspicuous location to the extent possible, not under tree drip lines and provide fencing/screening as necessary to preserve campus aesthetics.

### Protection of Underground Tanks and Pipes

All underground piping must meet requirements for proper installation, leak detection, corrosion protection and spill/overflow prevention. Underground storage tanks are not permitted. Consider concrete vaults or above ground tanks with secondary containment.

### Shielding of Equipment

Shield cooling towers, switches, transformers, etc. from view with architectural treatment compatible with adjacent structures. Acceptable solutions depending on the application include masonry walls (brick or architectural block) and Trex composite fencing.

## 33 50 00 Hydrocarbon Utilities

### New Natural Gas Service to Buildings

Every building or set of buildings which must be connected to Atmos natural gas infrastructure will be supplied using either commercial service, or transport service as determined by the total annual load. The minimum load to qualify for a transport service is 20,000 CCF per year. If any building or set of buildings has an expected load over 20,000 CCF per year, the project will employ Atmos Energy to extend the gas line from the main and install a transport meter. If any building or set of buildings has an expected natural gas load lower than 20,000 CCF per year, Atmos Energy will install a commercial connection and account.

## APPENDIX A: PERIPHERAL CAMPUS STANDARDS

### UNT Discovery Park Supplemental Standards

Latest Revision 6/11/2007

#### General

1. This list is not comprehensive but covers most of the common issues at the Discovery Park campus. Refer to the University Design and Construction Standards for all other requirements.
2. Any project that adds or removes walls in an existing Office or Lab affect utilities. (Electrical, Air Conditioning, Plumbing & Exhaust systems.) In order to prevent future Utility & Maintenance issues the Facility Management & Construction (FPDC) assigned Project Coordinator must involve Senior Facilities Maintenance personnel as assigned by Facilities Maintenance Management (FMM) from design through project completion.
3. Once design is complete, project drawings shall be issued by FPD&C for review.
4. **Roles and Responsibilities of assigned Facilities Personnel**
  - a. **FPDC Project Coordinator**
    - i. To request the assignment of Senior Facilities Maintenance Personnel to a project.
    - ii. Solicit design input from Senior Facilities Maintenance Personnel assigned to project
    - iii. Solicit approval input for submittals from Senior Facilities Maintenance Personnel assigned to project
    - iv. Perform the oversight and coordination of all assigned project work.
    - v. Conduct Pre-construction Meeting
    - vi. Single point of contact between FPD&C Client, UNT Facilities and General Contractor
    - vii. Coordinate any MEP shutdowns with Facilities Maintenance Personnel, and any department affected by shutdown
    - viii. Maintain paper trail of any and all project documents, change orders, request for information (RFI), request for pricing (RFP) etc.
  - b. **Senior Facilities Maintenance personnel as assigned to a project**
    - i. Provide support for FPD&C Project Coordinator.
    - ii. Give input on design issues and submittals.
    - iii. Perform the actual shutdown of any MEP system affected
    - iv. Observe progress of assigned project,
      1. As construction issues arise, communicate issues to FPD&C Project Coordinator
      2. Answer question for and ask questions of GC & SC on construction issues, but do not give direction to GC or SC.
      3. Report any safety issues to FPD&C Project Coordinator, & Facilities Safety Manager.
5. A pre-construction meeting is required prior to the beginning of any construction project. Attendees will be the FPD&C assigned Project Coordinator, General Contractor (GC) representative, Sub-contractor (SC) representatives, and Senior Facilities Maintenance

- personnel as assigned. The Facilities Construction office will perform the oversight and coordination of the work.
6. GC is responsible to provide submittals for approval on any Mechanical, Electrical, and Plumbing (MEP) equipment needed for project to the Project Coordinator.
    - a. Project Coordinator is responsible to solicit input from Senior Facilities Maintenance personnel as assigned, before approving submittals.
    - b. MEP SC must have approved submittals before ordering any MEP equipment.
  7. Any direction that results in a “Change in Scope”, Change Order, or increase in price will come from the FPD&C Project Coordinator to the GC only. Conversations between Senior Facilities Maintenance personnel as assigned and GC or SC are never to be considered “directing of a contractor”
  8. Both floors of Wing E and Wing F will have a perimeter 8’ to 10’ wide corridor running along the exterior walls on the west, south and east sides. This is how the building is designed to allow for direct travel to fire exits, access to mechanical rooms, and to allow natural light into the interior space. The main “trunk” ducts also run down this hallway.
  9. Any hard-wired card access system at the UNT Discovery Park campus must be connected to the DSX system.
  10. No rooms on exterior walls in Wing E, F and B.
  11. Whenever possible, transportation/delivery vehicles (such as golf carts and fork lifts) will use the tunnel system to move from one part of the building to another. The first and second floor concourse will be reserved for pedestrians only, as much as possible.
  12. It would be a violation of fire code to allow storage in the tunnel system. The tunnels will remain clear as vehicular access to freight elevators and also access to elevator machine rooms.
  13. Use university standard “Best” door hardware throughout.
  14. Color and finish selections should either match existing or follow the new standard finishes “pallet” developed for the Discovery Park.

**MEP General**

1. All new conduit, ducts, pipes, etc. installed in the open ceiling cavity to be painted to match existing.
2. Manufacturer for equipment such as circuit panels, switchboards, and variable frequency drives should be Square-D.
3. Piping Color Codes:

Darkest Green	Domestic “City” Water
Next Lighter Green	Condenser Water Supply
Next Lighter Green	Process Chilled Water
Next Lighter Green	Condenser Water Return
Lightest Green	Make Up Water Supply
Dark Turquoise	RO Water Supply
Turquoise	Compressed Air
Yellow	RO Water Return
Off White	Vacuum
Dark Red	Domestic Hot Water
Red	Heating Water Supply
Pink	Heating Water Return
Dark Blue	Chilled Water Supply

Light Blue	Chilled Water Return OR Fire Sprinkler
Unpainted Stainless Tubing	Nitrogen

**Mechanical**

1. The building has a process-cooling loop that will be maintained at 69 degrees F for lab cooling water requirements. Existing HVAC chilled water lines are reserved for HVAC use only.
2. The building has a central compressed air system for building wide use. Pneumatic air connections shall have building standard taps (check valves, valves & filters).
3. Existing HVAC & Lighting Control System is Schneider Electric EcoStruxure. The EcoStruxure Building Operation system will provide controls for any mechanical remodeling.
4. Existing VAV boxes in an area that is to be remodeled should be replaced as part of the project.
5. All new VAV boxes must have 277 or 480 VAC electric reheat, and Schneider Electric EcoStruxure Building Operation controls. Preferred Manufacture will be Trane, Price is acceptable substitute based on price and availability.
6. Installation of MEP equipment such as VAV boxes and ductwork may require full or partial shutdown of building systems. Prior to the beginning of the work the shutdown must be fully coordinated through the Facilities Construction office.
7. All new Air Handler Units (AHUs), Makeup Air Handlers (MAH), Fan Coil Units (FCUs), and Exhaust Fans (EFs) shall be direct drive. All new AHUs shall be manufactured by Trane unless the unit is a specialty unit that is not available through this manufacturer. Exhaust Fans shall be manufactured by Strobic.

**Electrical**

1. All building original light fixtures need to be replaced with single voltage / 277vac electronic ballast fluorescent fixtures with T-8 lamps. If a decision is made to upgrade any original lighting fixtures, ballast must be replaced with single voltage ballasts only. No dual voltage ballasts. No 8" fixtures will be retrofitted to T-8, All 8" fixtures must be replaced. T-12 lamps must be properly disposed of in accordance with EPA guidelines 40 CFR.
2. All building columns are also electrical power chases. The design should take this into consideration so that power is supplied from these columns wherever possible and the use of "power-poles" is kept to a minimum.
3. Electrical receptacle and voice/data cover plate color and material vary by location, consult UNT Architect for guidance.
4. All lighting in Areas A, B, D, E, F, G and M are on our Energy Management System (EMS), each area is divided into lighting zones. All remodel projects must take this into consideration and maintain the lighting zone. Or alter the existing lighting zones as appropriate to meet the needs of the end user and Facilities.
5. All electrical wiring should be run in high voltage tray in flexible conduit only. Conduit should be tied at intervals per N.E.C. No EMT, IMC, or rigid conduit will be run or laid in cable trays.
6. All hallway electrical receptacles circuits must be on separate electrical circuits from offices.
7. Rooms or Labs that house EMI Sensitive Equipment must be isolated from any electrical power or lighting circuits including circuit neutral conductors that do not direct feed power necessary for the operation of the room or Lab. This would necessitate the removal of all lighting circuits, their neutral conductor, and grounding conductors from the existing lighting grid as they pass through said rooms or Labs, and rerouting them around rooms or Labs as necessary to retain

our lighting control zones. Also, all traveler conductors necessary for 3-way lighting control switches must be installed in separate conduit and routed outside said rooms or Labs. 3-way switching should be eliminated from Rooms or Labs that house EMI Sensitive Equipment whenever possible

### Data and Communications

1. Any existing abandoned datacom cable in existing datacom cable trays will need to be removed prior to the installation of new datacom wiring as part of the remodeling project.
2. Datacom work that will be included as part of each remodel project at the Discovery Park will include: cable from the MDF to the IDF for that area, the equipment in the IDF for the area, and the drops to each service point as well as the HVAC and power in the IDF.
3. Each IDF room must be cooled 24/7, therefore a separate air handler unit needs to be provided for each room. The AHU should be connected into the existing chilled water loop system. The capacity of this unit will be 1.5 tons (600 CFM). The bottom of the unit should be mounted at 8'-0" AFF with a supply duct connecting to a supply register at 18" AFF. Also provide a thermostat to the unit in the room and a secondary galvanized steel emergency condensate drain pan. The drain line should be piped to discharge at a location where no equipment will get wet and where any discharge will be quickly detected. Each of the two (2) drain lines should be piped to separate drains.
4. All datacom wiring will be by owner. Contractor will provide conduit and j-boxes at each outlet location.
5. Power for all MDF and IDF rooms including power for lighting must be on a separate independent circuit from other building power functions.

### Cable Trays

1. Cable tray usage: Fire alarm & energy management shall use the north and west sides of the cable tray. Telecom shall use the south and east side. Each trade must keep to their respective side and all cable shall be neatly tied at all times.
2. Where cable leaves the cable tray, it will immediately enter into EMT conduit.
3. Use only MC type cable in non-control electrical cable trays.
4. Cable trays should not be used to support anything. If an exception is necessary, it must first be approved by UNT, then it should be kept to a minimum.
5. When attaching to a cable tray use beam clamps bolted to the outside lower flange of the cable tray. Then attach the object you wish to support to the beam clamp with all thread and the appropriate hanger.
6. When transitioning from MC cable to conduit, attach a 4x4 electrical box to the outside of cable tray. This can be done by drilling appropriately sized hole through the side of the tray and using a close nipple, lock nuts, nylon bushing on the box side, and a ridged conduit coupling on the inside of the tray to connect the MC connector to. This not only secures the box to the tray; it also creates a path for the wiring. If needed, a bolt on beam clamp only should provide additional support for the 4x4 box. At no time should anything be attached to a cable tray with a screw.
7. If it becomes necessary to seal a cable tray where it penetrates a wall, the plug must be made of a material that can be removed intact and replaced easily to allow for the addition or removal of cable in the future.

## Plumbing

1. All plumbing waste and vent pipes are to be cast iron.
2. Trenching of the slab for waste lines is to be kept at a minimum.
3. All water supply lines to be copper.
4. Limit the number of roof penetrations for plumbing vent pipes. Where possible vent pipes should penetrate roof/ceiling at the mechanical rooms, however keep in mind that the max. Horizontal travel distance allowed for vent pipes is 20'.
5. No wax seals at wall mounted toilets and urinals.
6. The standard for water heaters is to use instant heat type under-sink water heaters. No water heaters installed above ceiling or in remote locations.

## APPENDIX B: TELECOMMUNICATIONS AND DATACOMMUNICATIONS STANDARDS

Latest revision: 6/18/2020

The UNT System IT Shared Services (ITSS) Telecommunications Services department is the authoritative source for all design and construction standards regarding telecommunications and data communications infrastructure for the UNT System and campuses.



### UNT System IT Shared Services Standards

#### Telecommunications

##### GENERAL:

1.1 These standards apply to all telecommunications installations within the University of North Texas System. Separate standards are presently in place for the University of North Texas Health Science Center and UNT Health.

1.2 The Department of Information Resources has determined that most buildings at the Universities fall into the category of special purpose buildings, resulting in a far lower density of workstations than the TIA/EIA 569-A standard assumes. Because of that, it is appropriate to base the allocation of space for communication rooms on the number of faceplates actually served and not on square footage. Limiting the number of faceplates served from an individual communication room will ensure that an appropriate number of communication rooms are planned.

1.3 This voice and data vendor will be responsible for all cabling, fiber, J-hooks, voice and data jacks and faceplates, wireless access point (WAP) installation, patch cords, racks, ladder rack, vertical/horizontal wire managers, and patch panels. ITSS Telecomm will provide the telephones. The general contractor (GC) is responsible for pathways, indoor-outdoor conduits, boxes, buildout of Communications rooms, electrical, A/C, plywood, lighting, pull strings, cores, cable trays if needed, TMGGB. ITSS Datacom will provide switch gear, wireless access points, UPS (if not provided by general contractor for the entire

September 30, 2024

Page **159** of **303**

building) BOM. We would like for each building to have a main UPS that feeds all power within each Communications room. If not Feasible then ITSS Datacom will provide BOM for UPS per each Communications room.

1.4 During construction, after 100% designed and engineered, if changes/revisions are made we will need updated prints showing these changes—we will not be responsible to look at the GC’s link. We will need a hard print and electronic copy.

2.0 DESIGN REQUIREMENTS:

2.1 The University will base its space allocation for communication rooms on the following matrix, which allows for equipment space requirements to service an immediate need for a designated number of faceplates, growth of voice and data jacks, and some expansion of services:

Maximum # of Cables Served	Minimum Communication Room Size
400 or MDF	12’x20’
200	12’x16’
96	12’x14’
HUB	20’x25’

2.2 The above requirements are sized to provide significant growth capacity such as might occur during normal future expansion of the network. After initial installation, the number of faceplates serviced from a closet may increase. However, this increase will not be permitted beyond the capacity of equipment or racks which may be installed in a room according to the above guidelines. **The Main Distribution Frame (MDF) minimum room size is 12’x20’.** **The Intermediate Distribution Frame (IDF) minimum room size is 12’x14’.**

2.3 Each floor should have its own telecommunications room; the communications rooms should be centered on a floor and be vertically stacked. In some cases, it may not be feasible or economically viable to have a telecommunications room on each floor. In such cases:

A telecommunications room will only be permitted to service one floor above and one floor below its location, in addition to the floor on which it is located. There will be a minimum of 3-4” conduits from the floor the Telecommunications room is located on to the ceiling of the floor below and the ceiling to the floor above for routing of cabling.

The communication room station cabling will not exceed 295ft. Due to this limit, consideration of placement of communication rooms is critical. This 295ft. limit is determined by communications pathways and conduit routing, rather than hallway and building layout. If cabling is over this limit Fiber and media converters will be installed. The communications room should be **centered** within the building. If this is not possible, an additional communication room will be needed. If additional communication rooms are needed, we require minimum 3-4” conduits with pull string from the MDF communications



room to each additional communication room. **These conduits will not go in the ground.** If all communications rooms are stacked then a minimum 3-4" sleeves with bushings are required.

2.4 ITSS Telecommunications requires a floor plan of the building that only shows the communications symbols, the room numbers and the furniture layout. If the building has multiple floors, we need floor plan for each floor. **Each floor will be on one sheet not in sections.**

2.5 Requirements for cabling in offices, PC labs, and modular furniture are as such. Each office will have 1 voice cable and 2 data cables in one location. In PC labs, each PC will have 1 data cable. Single modular furniture will have 1 voice cable and 1 data cable. Double modular furniture will have 1 voice cable and 2 data cables. Small workstations will have 1 voice cable and 1 data cable. Large workstations will have 1 voice cable and 2 data cables. If VOIP will be installed we will engineer cabling requirements during the design phase.

2.6 No other trade will use any communication room to place their equipment in or to use our communications room as a pass thru or chase for routing of any cable, water pipes, duct work or any other utility. This is in and above all new communications rooms. Communications rooms will not be used for storage. If room is needed from another trade in any communications room the communication room needs to be larger than our standard size and a cage can be installed to separate trade equipment. If this is needed, this needs to be coordinated through ITSS.

2.7 A cellular distributed antenna system will be discussed for each new building.

2.8 Wireless access point placement will be per design of ITSS Data communications only. They are only to appear on prints as designed by ITSS Data communications.

2.9 If leased or temporary spaces are needed by UNT, UNT Law School and UNTD, the space will still require its own communications room. Each of these spaces will be designed separately by ITSS.

2.10 In new construction a minimum of 3-6" conduits with mule tape will be installed from IT room MDF to curb/pole or to one of our existing manholes. All conduits need pull string and outdoor conduits require mule tape.

2.11 Voice Jacks are International White- IW, Data Jacks are Green GR, Security Camera Jacks are Orange OR, WAP Jacks are Yellow. Each Voice will have 1 CAT 6 White 7ft. Patch Cord, Data and Security Cameras will have 2-CAT 6 patch cords-1 14ft. at communication outlet and 1 5ft. for IT room. For classrooms with less than 100 seats, WAP's will have 1 CAT 6A patch cord 5' for IT room, 14 ft. at WAP. For classrooms with 100 seats or larger, WAP's will have 2 CAT 6A patch cords 5' for IT room, 14ft. at WAP. These patch cords all match the color of the jacks. See BOM below for all part numbers. All horizontal cable is blue except when cable needs to be exposed-we will let UNT System choose the color that fits these areas. All cable CAT 6 except WAP and RED inter-closet cables CAT 6A. Color of Faceplates will match electrical outlets.

2.12 The voice patch cords will be patched over in each communication room by Vendor from the station rack voice jack to the voice rack to patch panels or with-in a rack The # of white patch cords you patch over will be determined by how many voice cables are in the station rack. You will then provide a cut sheet that shows what voice station # goes to what port on the voice patch panel and then what tie

pair. back down to the MDF and what tie pair on the feeder cable back to MDF IT room 1A. All voice cables will be patched over in each IDF back to the MDF. Example IT room 2A-49 port of Station Rack patched to 2 ports of Voice Rack-jumper wired to 1<sup>st</sup> pair of feeder cable.

- 2.13 In each voice rack in each IT room a 1-pair Avaya jumper wire will be installed from 110 rack mounted block C-5 clip to the 110-rack mounted block C-4 clip white/blue position. As many voice cables as you have in the station rack in each communication room will determine how many jumpers are installed and how many ports and patch panels are needed in the Voice Rack. The power point pic shows 192 ports. This is maximum now since we typically do VOIP less ports are needed. Again, as many voice cables plus some future growth for this Voice Rack. Each port of the top patch panels gets 4 pair per port. The 2<sup>nd</sup> and 3<sup>rd</sup> pair are reversed. Example 1<sup>st</sup> port-wb/bl wg/gw wo/ow wbr/brw.
- 2.14 Vendor will install all WAP's after network is brought up per ITSS Data communications direction. After installed ITSS WAP Team will test WAP signal and if needed Vendor will need to tilt WAP or turn WAP a certain direction possibly several times. A WAP location cannot be relocated without ITSS WAP Team approval. All WAP's will be labeled at the biscuit jack and on the WAP. If mounted above drop ceiling a black label with white lettering will be installed on the grid wire.
- 2.15 Vendor will install all patch cords at communications outlets after testing is completed or at ITSS direction.
- 2.16 2ea. Red Panduit CAT 6A cables will be installed from IT room 1A MDF to each additional IT room IDF terminated on Panduit red CAT 6A jacks inserted into a patch panel the top of the Equipment Racks. 100 pair minimum CAT 3 Voice feeder cable from IT room 1A MDF to each additional IT room IDF room. In IDF's cable will terminate on rack mounted 110 blocks. In IT room 1A MDF this feeder cable will be installed on wall next to service provider demarc. See Voice Rack Layout for placement. Corning armored 12 Strand 10 GIG OM4 50 Micron aqua Fiber from 1A MDF to each additional IT room IDF, these will terminate in the equipment Racks. MM Fiber gets LC connectors-Single Mode Fiber gets ST connectors. If new building is being constructed on UNT, UNT Frisco, UNT Dallas Campus's a 24 Strand Single Mode Fiber and 200 pair copper CAT 3 Voice feeder cable will be installed from one of the existing HUBs to this new building.
- 2.17 See PIC of IT room Rack Layout and 3 Rack ITSS Standard. Vendor is responsible for all of these items and installing voice jumpers/patch cords and cross connects. See 2.12 and 2.13.
- 2.18 As many Double-sided Panduit wire managers Vendor uses in Station Rack- they will provide single sided Panduit wire managers for the Equipment Rack for patching.
- 2.19 All cable will be terminated with 568A pinout. Each cable will be labeled at the patch panel-on the cable at each termination point and communication outlet. See labeling of WAP standards in Datacom standards below.

### 3.0 INSTALLATION REQUIREMENTS:

In new construction, wiring upgrades, or installations, the University will not permit the installation of cable that is not appropriately rated for use in space that is designed as a return air plenum. After deactivation resulting from a regularly scheduled remodel or systems upgrade, the University will not permit non-rated cable to remain in any space designed as a return air plenum.

#### New communications rooms should have the following:

- **One quad with 120V 20 Amps and three NEMA L5-30 120V 30A circuits to support UPS requirements, all at floor level. These circuits will be installed at the bottom of the telco racks. Telecom will place these on drawings after room has been allocated.**
- **Standard 20-amp duplex receptacles at standard height at 6-foot intervals around the room. Electrical contractor will furnish a TMGB in the MDF and a TGB in each IDF. Each wall of the room will have ¾" fire retardant plywood installed.**

- **Chilled Water/CRAC air conditioner, separate from the rest of the building, and not installed within the room. No duct work is to be installed within the room, only the supply vent and return vent on a wall. This is a dual unit so when the chilled water is shut off the CRAC unit will take over. Minimum size 43,000 BTU/HR—3.5 tons.**
- **Each Communications room will have lighting per EIA/TIA standards.**
- **All electrical outlets and HVAC power are to be placed on emergency or generator backed up power.**
- **A Floor Drain is required for any newly constructed communications room.**
- **During life time of this new building or a renovation of existing buildings the A/C will be part of the building's maintenance, ITSS is not responsible for replacement or repair of these HVAC units, rather the building maintenance fund will be responsible.**

### 3.1 COMMUNICATIONS ROOMS, CABLE TRAY AND PATHWAYS:

All cable tray pathways and communications rooms must be free and clear of all obstacles such as: sprinkler system ducts, pipes and drains, electrical conduits, electric motors, A/C ductwork, ventilators, plumbing pipes, and fluorescent lights. There will be 12 inches of clearance above, below, and to each side of the cable tray. The type of cable tray to be used is Panduit WG18BL10. The cable tray will be installed to Cablofil's specifications. Any communications room will not be next to, above, or below an electrical room due to EMF interference. Communications room's walls should be insulated well due to noise. If cable pathways pass through electrical rooms or mechanical rooms hard conduit will be needed.

The voice and data vendor will be last trade in the ceiling. Cabling is to be installed just prior to installation of the ceiling grid. This pathway will be used when building is being constructed and for future adds

### 3.2 FURNITURE AND MODULAR FURNITURE

Communications outlets must be easily accessible and not obstructed by furniture or other materials. A whole cut into furniture, quarter mod furniture or back panel can be used to provide access to outlets. Communications outlets are usually installed @ 18" AFF. ITSS needs access to each communications outlet for E911 mapping.

### 3.3 COMMUNICATIONS OUTLETS

All wall outlets, WAPs and security camera locations require a 1" conduit installed from a deep four-square box with a single gang plaster ring to above the drop ceiling with a bushing installed. If no drop ceiling is installed in a location, then we need the conduit to be installed back to the cable tray. If a WAP is installed in an open area ceiling the WAP box must be slightly lower than the lights. In these areas an all thread can be used here with a deep four-square box attached to bottom.

**If floor poke-throughs are installed, we require a 1" conduit from the poke-throughs in the floor to the ceiling above a wall in the room where this poke-through is installed.**

### 3.4 FUTURE NEEDS

For new building construction, there will be several locations where we require a 2" conduit installed, stubbed out underground at 24" and capped off. The other end of this conduit will be installed in the

ceiling of the hallway or installed back to nearest IT room. Pull String installed in conduit. These should be shown on site plan.

4.0 TESTING, AS BUILTS AND LABELING:

4.1 All testing will be done with Fluke testers and cabling will be tested after faceplates have been installed not before. We require hard copies and electronic copies of test results. All fiber will be tested bi-directional with power meter and Fluke.

4.2 A print showing each communication outlet per floor will be placed in each IT room on a wall showing the label port number. This print will be laminated. Any added cable during construction will be added to these prints and labeled. In the future when any cable is added it will be added to this print and labeled. UNT ITSS should get electronic copy of this print 4 weeks before network is brought up.

4.3 Each communication outlet and ports of this outlet will be labeled as shown: if there is 1 IT room on the 1<sup>st</sup> floor of a building this IT room will be 1A. This will be the MDF. If there is another IT room on the 1<sup>st</sup> floor it will be 1B-etc. This is same on all floors of a building the 1,2,3,4,5 floors will change and if Multiple IT rooms are on a floor A, B, C D. At each communication outlet each port or jack will have the port number it is terminated in the IT room in the patch panel. Example 1 cable from 1<sup>st</sup> IT room on 1<sup>st</sup> floor-1A-01, 2 cables from 2<sup>nd</sup> IT room on 2<sup>nd</sup> floor-2B-01-02, 3 cables from 3<sup>rd</sup> IT room on 3<sup>rd</sup> floor-3C-01-02-03. All WAP's and security cameras will be installed at the Top of the station rack. Each will get their own patch panel.

5.0 BILL OF MATERIALS

CAT 6 Cabling Panduit PUP6004BU-W NO ALTERNATES

WAP Blue Cable/Inner Closet RED Cabling all Panduit CAT 6A PUP6AM04BUUGA

Corning Fiber- NO ALTERNATES

MATERIAL	PART NUMBER
Chatsworth 12" Black Ladder Rack	10250-712
Chatsworth 19" Relay Rack	55053-703
Chatsworth Junction Splice 90 Kit (BLK)	11302-701
Chatsworth Rack To Runway Mounting Plate	10595-712
Corning 2U Rack Mount Fiber Cabinet	CCH-02U
Corning 12 Strand MM 50/12510GIG Armored Fiber	012T88-33180-A3

Corning MM Fiber Adapter Panel 6 Duplex LC	CCH-CP12-E4
Corning MM LC Fiber Connectors	95-050-99-X
Hilti 6' Hanger w/Yellow Shot	299527
Panduit 1.31" J-Hook	JP131W-L20
Panduit 2 Module Surface Box	CBXJ2IW-A
Panduit 48-Port Mini-com Patch Panel	CPPL48WBL Y
Panduit 4-Port Sloped Executive Faceplate	CFPSE4IW
Panduit 6" Vertical Manger	PRV6
Panduit 6" Vertical Manger Door	PRD6
Panduit Category 110 Rack Mount Panel	P110B1004R2Y
Panduit Category 110 Rack Mount Panel w/Jumper	P110B1005R4WJY
Panduit Category 5e 48-port Patch Panel	DP485E88TGY
Panduit Category 6 Mini-Com TX-6 Module (Green)	CJ688TGGR
Panduit Category 6 Mini-Com TX-6 Module (Red)	CJ688TGRD
Panduit Category 6 Mini-Com TX-6 Module (White)	CJ688TGIW
Panduit Category 6 Patch Cord (Green) 5ft	UTP28SP5GRY
Panduit Category 6A Patch Cord (Yellow) 5ft	UTP6ASD5YL Y
Panduit Category 6 Patch Cords (Green) 14ft	UTPSP14GRY
Panduit Category 6 Plenum Cable Blue	PUP6004BU-W
Panduit Category 6 TX-6 Module (Yellow)	CJ688TGYL
Panduit Front Only Horizontal Wire Manager	NCMHF2
Panduit J-Hook 2"	JP2W-L20
Panduit Voice Patch Cord (White) 7ft	UTP28SP7
Superior Essex 50-Pair Category 3 Plenum Feeder	10032112
Corning I/O Armored 12 Strand Single Mode Fiber	012E8P-31131-A3
Corning ST Singlemode Adapter Panel	CCH-CP12-19T
Corning ST Singlemode Fiber Optic Connector	95-200-52
Panduit Category 6A Patch Cord (Yellow) 14ft	UTP6ASD14YL Y
Corning OSP 24S SM Fiber	024ZU4-T4F22 D20

6.0 CONTRACTOR VENDOR QUALIFICATIONS

Voice and Data contractor will be Panduit Gold and Corning Certified and be able to provide their Warranty.

Data communications

**\*The following specifications and standards must be met prior to installation of network infrastructure. No connectivity can be provided by ITSS prior to these conditions being met. \* If these Standards aren't followed ITSS System cannot guarantee the performance of today's Network Performance Connectivity and any Future Network Performance Connectivity.**

## 1.0 CABLING

- 1.1 All fiber and copper cabling to be run and terminated per ITSS Telecom standard. The following items are specific to Datacom concern.
- 1.2 Jack labels must be consistent between end point and MDF/IDF IT rooms. Example: 1A-01= MDF 1A IT room 1<sup>st</sup> port in Station Rack. 2B-02= 2<sup>nd</sup> IT room IDF on 2<sup>nd</sup> floor 2<sup>nd</sup> port in Station Rack-3C 110- 3<sup>rd</sup> IT room IDF on 3<sup>rd</sup> floor 110 port in Station Rack-See Telecom's Standards as well.
- 1.3 A legible print detailing labeled jack locations within the buildings to be provided by contractor to ITSS electronically. Prints also must be posted within the MDF/IDFs. See Telecom's standards.
- 1.4 Cabling to be completed and certified by Panduit/Corning Vendor prior to installation of network gear.
- 1.5 ITSS, Facilities, and contractor to agree on an acceptable timeframe for repair or replacement of defective cabling to meet a specific SLA with customer.

## 2.0 MDF/IDF BUILDOUT - to prevent damage/theft these specifications must be met prior to installation of network gear.

- 2.1 Communications rooms (MDF/IDFs) to be built out per ITSS Telecom standard. The following items are specific to Datacom concern.
- 2.2 20A duplex receptacles and 30A L5-30 receptacles to be terminated and tested
- 2.3 Independent air conditioning unit to be tested and functional per Telecoms Standards.
- 2.4 UNT telco lock core to be installed.
- 2.5 Equipment from all other construction disciplines must be removed from the room and room must be free of dirt, dust, debris.
- 2.6 ITSS Datacom requires a minimum of two weeks to install and test network gear. Communications rooms must be completed to Telecom/Datacom specification two weeks prior to any requirement for network connectivity.

## 3.0 NETWORK GEAR

- 3.1 ITSS Datacom will provide a parts list for purchase. This list will include but is not limited to routers, firewalls, switches, optics, optical cabling, UPS systems, temperature sensors, wireless access points and maintenance contract requirements.

- 3.2 All purchased parts to be sent to UNT Central Receiving and delivered to ITSS Datacom from there.
- 3.3 ITSS Datacom will configure, test, and install all gear listed above and retain sole responsibility for all configuration changes and physical changes made.
- 3.4 Contractor/vendor to provide and verify complete list of parts ordered along with serial numbers.

#### 4.0 WIRELESS SERVICE

We (ITSS) will provide the following:

- 4.1 The design of the system with proper location on the building print for each AP.
  - 4.1.1 If a WAP needs to be moved due to building changes, we need to approve new location
  - 4.1.2 If more WAPs are needed than originally planned – approve modifications of plan
  - 4.1.3 Coordination of purchasing with change orders
  - 4.1.4 Cabling lengths must be with spec for all locations especially outdoor
  - 4.1.5 Conduits put into place early in project for outdoor WAPs and/or future expansion
  - 4.1.6 All WAP location changes must be approved by wifi team in order to maintain design
  - 4.1.7 Any and all WAP locations placed in plan by architect should be removed. Wifi team will provide all design for integration into campus plan
  - 4.1.8 Model of WAP will be decided by wifi team. Cabling plant will be determined by wifi team as to one or two cables per WAP
  - 4.1.9 WAP design includes placement for attenuation, density, and types of service.
- 4.2 The mounting instruction and direction for mounting each AP per standard.
  - 4.2.1 ITSS will specify each mount type and orientation of each model WAP based on ceiling type:
    - 4.2.1.1 Type A: suspended ceiling rail, flat 9/16
    - 4.2.1.2 Type B: suspended ceiling rail, flat 15/16
    - 4.2.1.3 Type C: suspended ceiling rail, profile 9/16 for tiles below grid
    - 4.2.1.4 Mount to standard electrical box: 1 or 2 gang
  - 4.2.2 Direction specifications for all antenna.
- 4.3 Cable labeling convention for each AP at both ends.
  - 4.3.1 Label must be placed on all WAP.
  - 4.3.2 Label must state IT room number.
  - 4.3.3 Label on patch panel – must have room number scheme per Wifi team.
  - 4.3.4 All cabling must be properly tied up and off of ceiling tiles.
  - 4.3.5 As built plan MUST be placed in each wiring closet.
  - 4.3.6 All cabling MUST follow IEEE specs as well as ITSS specifications.
  - 4.3.7 All outdoor cabling for WAPs must be outdoor rated.
  - 4.3.8 Drip loops and vendor seals must be placed on all outdoor WAPs.
- 4.4 Lightening arrestors must be placed on all outdoor WAPs.
- 4.5 Part number for each item that needs to be purchased.

- 4.6 Part number for any licenses that needs to be purchased.
- 4.7 Provide ITSS SLA specification to the vendor.
- 4.8 Must use Aruba as our manufacturer for all WAP products.
- 4.9 All new equipment – no refurbished materials.
- 4.10 180 Day time period to verify all functionality of WIFI. Time starts as soon as network switches have been installed and tested.
- 4.11 Scheduling of service and testing must be allocated around class schedules and any other construction work going on.

Contractor will provide the following:

- 4.12 Install each AP based on the design of the System with proper location on the building print for each AP +/- 2 feet.
- 4.13 Clearly identify the location of each AP on the print.
- 4.14 Label each cable at both ends as specified. See Telecom’s labeling.
- 4.15 Provide the MAC address for each AP referencing its physical location and Port Number.
- 4.16 Support Installation for a period of two years after installation within the ITSS SLA specification

**Prepared By**

Document Owner(s)	Organization
Dowl Morrow (Primary)	ITSS Telecom
Bryan Daniel (Secondary)	ITSS Telecom
Blake Meyer (Secondary)	ITSS Datacom

**Version Control**

Version	Date	Author	Description
1.1	12/06/19	Dowl Morrow	Updates include new Datacom standards
1.2	06/18/20	Bryan Daniel	Revised WAP patch cable requirements in section 2.11 and ceiling mount types in section 4.2.1 per Kenneth Haynes.

[Supplemental Information](#)



Closest Track Layout

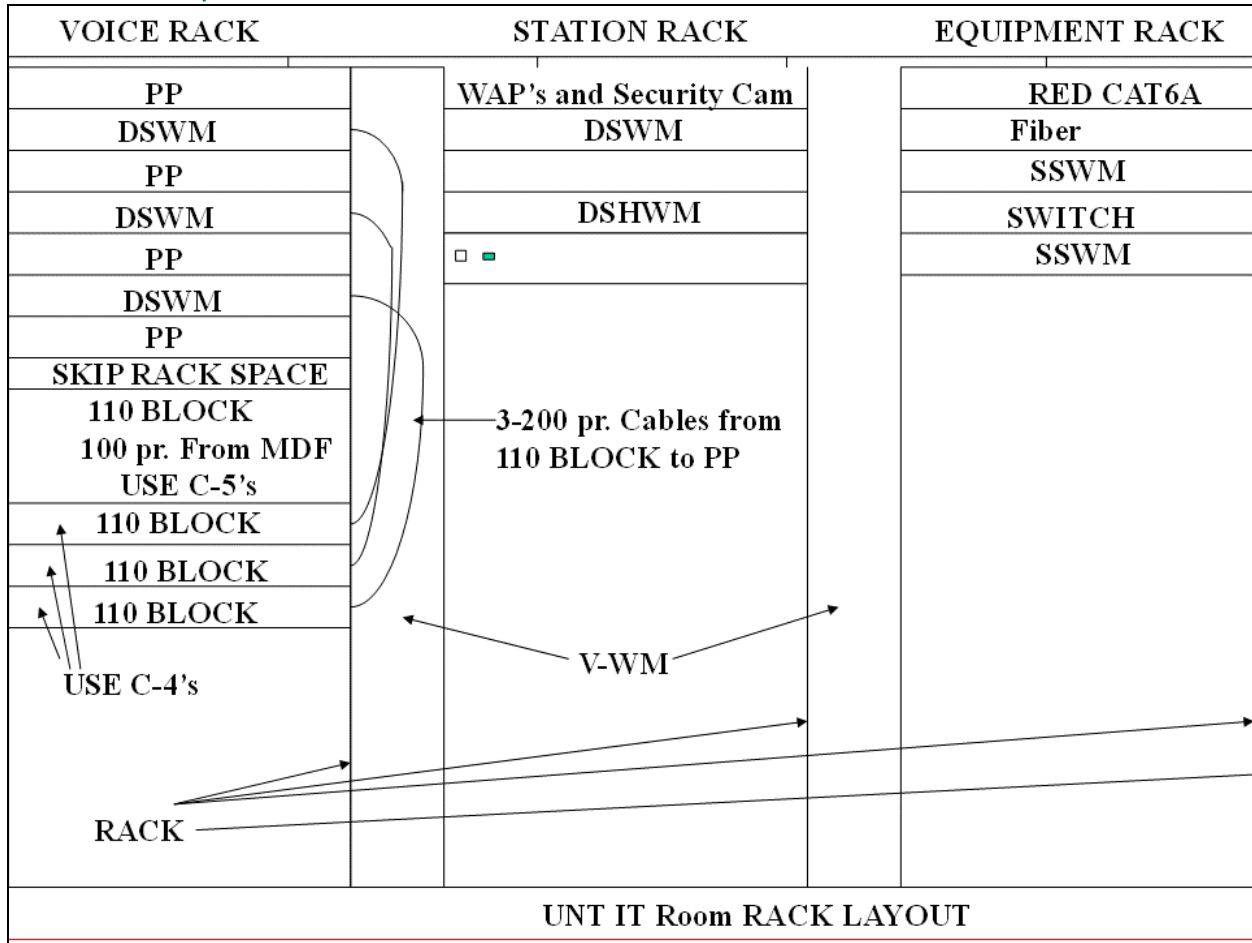

Jack Terminations

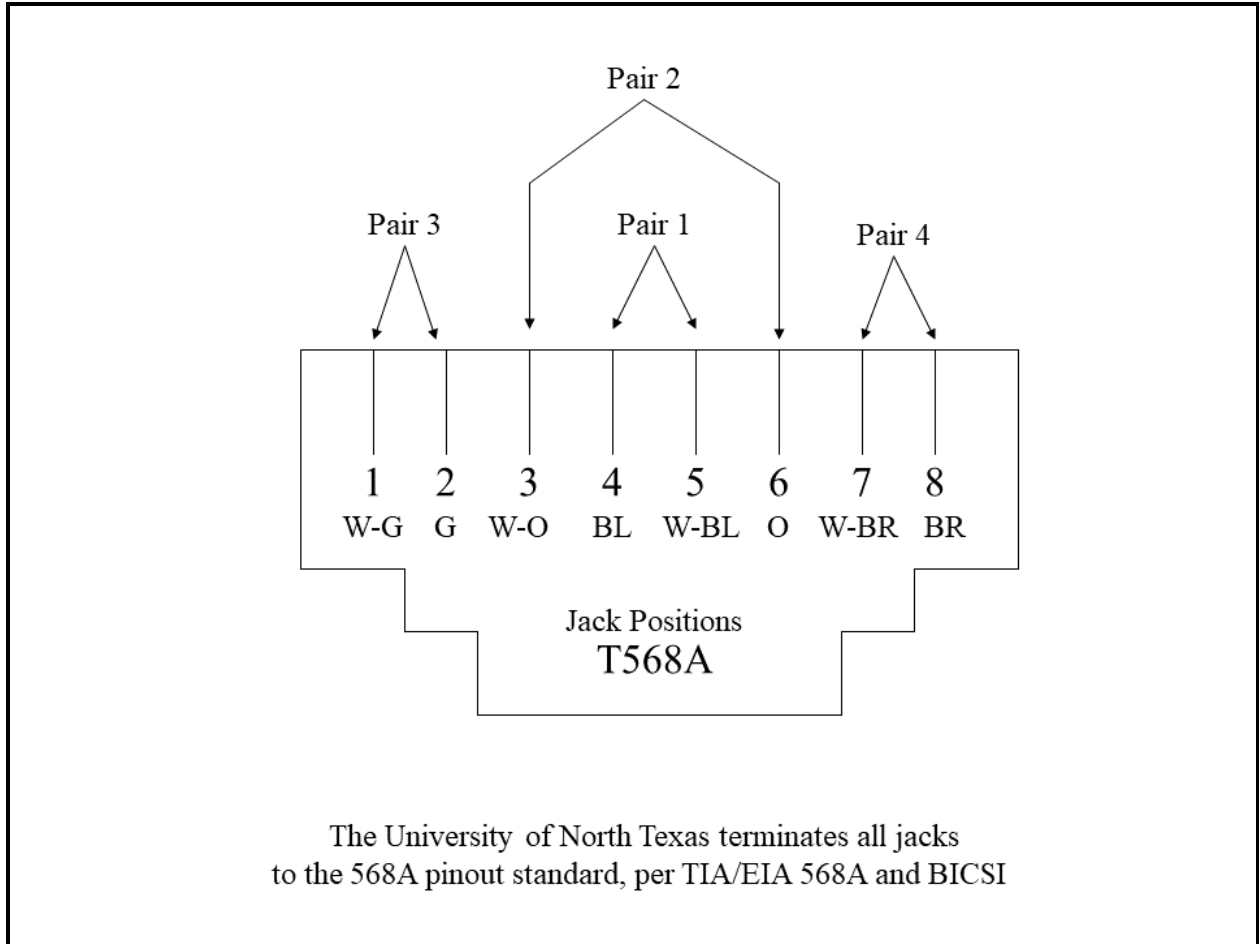

## APPENDIX C: FIRE PROTECTION SYSTEM SPECIFICATIONS

### UNT System Fire Marshall Fire Protection Standards

The following specifications are under the authority of the University of North Texas System Fire Marshall.

#### Underground Fire Sprinkler Main

#### UNIVERSITY OF NORTH TEXAS SYSTEM

#### UNDERGROUND FIRE SPRINKLER MAIN

#### SECTION \_\_\_\_\_

#### PART 1 – GENERAL

##### 1.1 RELATED DOCUMENTS

Drawings and general provisions of the Contract, including General and Supplemental Conditions and other Division 1 Specification Sections apply to this Section

##### 1.2 SUMMARY

- A. This section addresses underground fire-sprinkler main water-service piping (fire mains) and its related components extending from the connection to the public water utility supply tap and into the building, as indicated on the approved design drawings.

##### 1.3 SUBMITTALS

- A. Product Data: Manufacturer's specifications for each type of product to be used on project.
- B. Shop Drawings and details indicating locations and depths of underground main and FDC piping; size of pipe, fittings and valves; type of pipe and fittings materials; size, type and location of pressure blocking; type of backfill material(s); type(s) of underground risers; location and type of vaults, backflow devices, flow meters, and yard valves.
- C. Copies of the contracting firm's Texas Department of Insurance (TDI) Sprinkler Contractor Registration – General (SCR-G), Responsible Managing Employee - General (RME-G), Responsible Managing employee Underground (RME-U) and the required Texas Department of Insurance's Liability Insurance Certificate, signed by a Texas Insurance Agent.

##### 1.4 QUALITY ASSURANCE

- A. The contracting firm installing the underground fire main shall specialize in the design and installation of underground fire mains. The firm shall have a minimum of three years of verifiable design and installation experience in underground fire mains.
- B. Piping materials shall bear label, stamp, or other markings of specified testing agency.
- C. The Contractor shall protect all piping materials from contamination during storage, handling and installation. All openings in the pipeline shall be closed with watertight plugs when pipe laying is stopped or at the close of the day's work.

- D. Regulatory requirements:
1. Comply with all requirements of the public water purveyor's, TCEQ's and UNTS' requirements for connecting to the public utility water main.
  2. Comply with NFPA 24 and direction of UNTS for materials, installation, tests, flushing, chlorination, valve and associated appurtenances for fire suppression water service piping.
  3. Comply with UL's "Fire Protection Equipment Directory", or FM's approval of fire-service main products.
- E. Minimum Required Inspections:
1. Visual inspection of the installation shall be performed **PRIOR TO** covering any of the pipe, joints, fittings, valves, ductile iron, thrust blocks, restraints or other metal parts. Where any part is so covered prior to the visual inspection, the contractor will be required to uncover the part(s) for visual inspection at no cost to Owner.
  2. Pipe labeling must be turned upward and visible.
  3. Depth of bury of the pipe will be measured and verified.
  4. All angle fittings shall be pressure blocked with poured-in-place cement pressure blocks or anchored retaining straps. Pressure and gravity anchor blocks shall be appropriately sized per NFPA 24 or by a Texas Professional Engineer and bear onto undisturbed soil.
  5. All metal components being installed underground shall be externally coated for corrosion and poly-wrapped.
  6. Hydrostatic Testing of the fire sprinkler underground main is required.
    - a. All new fire service mains shall be tested hydrostatically at not less than 200 psi pressure for a minimum of two hours, or at 50 psi pressure in excess of the maximum static pressure when the maximum required static pressure exceeds 150 psi.
    - b. A pressure loss of more than 5 psi, or leaks will result in a failed inspection.
    - c. The Hydrostatic test shall be made by the installing contractor and witnessed by the Owner's Representative.
  7. Cleaning, disinfecting, flushing and biological testing:
    - a. Underground fire mains being connected to any potable water utility line must be disinfected, flushed and pass bacteriological testing prior to being connected to any potable water utility line.
    - b. Isolate fire main system from public water utility main with RPZ backflow prevention device.
    - c. Clean new piping system and parts of existing system that have been altered, extended or repaired.
      - i. Use flushing procedure described in NFPA 24 for flushing of pipe.
      - ii. Use disinfecting procedure described in AWWA C651.
      - iii. Once disinfecting test is complete and approved, re-flush the underground piping and perform bacteriological testing.
      - iv. Samples for bacteriological analysis will only be collected from suitable sampling taps and collected in sterile bottles treated with sodium thiosulfate. Samples shall not be drawn from hoses, fire hydrants or unregulated sources.
  8. Flushing, disinfecting, re-flushing and bacteriological sampling of lines shall be done by the installing contractor and witnessed by the Owner's Representative.
  9. Proper methods and equipment to perform the flush must be used. All piping used to flush must be properly secured or restrained. Owner's Representative must approve of flushing method and equipment.

#### 1.4 COORDINATION

September 30, 2024

Page **172** of **303**

- A. Coordinate location of underground fire main with fire sprinkler contractor, UNT Utilities Supervisor and public water purveyor's requirements. Coordinate FDC location at the direction of the UNT System Fire Marshal.

## PART 2 -- PRODUCTS

### 2.1 WATER PIPING MATERIALS

- A. Underground -- Polyvinyl Chloride (PVC) Pipe (NO EXCEPTION)
  - 1. American National Standard for PVC pipe 12 inches and under, AWWA Standard C900, Class 200 (DR14).
  - 2. Pipe greater than 12 inches shall be AWWA Standard C905, Class 200 (DR14).
  - 3. Color: Blue
- B. Riser shall be one-piece Ames Stainless Steel In-Building Riser.
- C. Valves:
  - 1. Gate valves, 12" and under (resilient seated): AWWA C509 Standard
    - a. General Description: Valves shall be full opening, iron body, non-rising stem, resilient seated wedge type so designed to have complete **ZERO** leakage with flow in either direction at pressures up to two hundred (200) psi. The valves shall be designed for throttling if required.
    - b. Coating: Valves shall have all internal ferrous metal surfaces coated with a factory-applied AWWA approved epoxy coating to provide a corrosion resistant barrier. The epoxy coating shall be holiday free with a minimum thickness of not less than four (4) mils.
    - c. Operating stems: Valves shall have two (2) "O" ring stem seals. Valves shall have the thrust collar and bearing surfaces isolated from the waterway and be provided with continuous lubrication, or they shall be provided with non-corrosive thrust bearings above and below the thrust collar. Where the operating nut exceeds forty-eight (48) inches, in depth (below finish grade), a permanently attached extension shall be attached to the valve stem to bring it to the minimum depth of forty-eight (48) inches. All valves shall open by turning to the left and shall have a two (2) inch operating nut or be hand-wheel operated as shown on the plans.
  - d. Approved Manufacturers:
    - i. Mueller
    - ii. Waterous
    - iii. Kennedy
    - iv. American-Darling
    - v. Clow Corporation
    - vi. J&S Valves
- D. Fittings:
  - 1. Mechanical Joint: ANSI/AWWA-C110/A21.10 or ANSI/AWWAC153/A21.53 Standards
  - 2. Flange Joint: ANSI/AWWA-C111/A21.11 or ANSI/AWWA-C153/A21.53 Standards
  - 3. Push-on Joint: ANSI/AWWA-C111-A21.10 or ANSI/AWWA-C153/A21.53 Standards
  - 4. Fittings: Ductile Iron ANSI/AWWA-C153/A21.53; Cast Iron ANSI/AWWAC110/A21.10 and ANSI/AWWA-C111/A21.11 Standards.
  - 5. Bends: ASTM D-3139. Megalug™ retaining glands or equal shall be used on all bends, tees and plugs
  - 6. Gaskets: ASTM F477 Standards
  - 7. Bolts, Bolt-studs and "T" Head Bolts:
    - a. Length: Shall be such that the ends project ¼ to ½ inch beyond surface of nuts.

- b. Ends: Chamfer or rounded.
- c. Threading: ANSI B1.1 coarse thread series, class 2A Fit. Bolt-studs may be threaded full length. Studs for tapped holes shall be threaded to match threading in holes.
- d. All bolts, bolt-studs and "T" head bolts (ANSI/AWWA C1111/A21.11-80) shall be either:
  - i. A242 high strength low alloy steel with enhanced atmospheric corrosion resistance (ASTM A325 Type III); or
  - ii. Stainless Steel Grade 304 or 316 high strength bolts
- e. All nuts are to be A563 carbon alloy steel; Grade and finish to be C3.

**Exception:** All-thread rod to be used in thrust harness only, shall be high strength, corrosion-resistant alloy (ASTM A325 Type II) with hexagonal nuts. Where all-thread rods, nuts and washer are used, they are to be painted with "ROYSTON ROSKOTE MASTIC R28" Rubberized mastic as manufactured by ROYSTON LABORATORIES, INC. of Pittsburgh, Pennsylvania or equivalent.

### PART 3 - REACTION RESTRAINTS AND THRUST-BLOCKING

3.1 Restraints and thrust blocking for all piping with mechanical coupling, push-on or mechanical joints, or similar joints subject to internal pressure shall be thrust-blocked or restrained per NFPA 13 for Underground Piping to prevent separation of the joints.

- 1. Thrust-blocking shall be designed (placement, size, cement mix) by the RME-G or a Texas Registered Professional Engineer and shown on the installation plans.

### PART 4 - EXCAVATION

4.1 Excavation: Excavation in general, shall be made in open cut from the surface of the ground and shall be no greater in width and depth than is necessary to permit the proper construction of the work.

- A. Excavating and trenching shall be performed in accordance with State of Texas Law and OSHA requirements.

Underground utilities in the area(s) being excavated shall be located, identified and marked.

Contact UNTS Project Manager for locates on UNT property.

Call *TEXAS* 811 (dial 811), 48 hours in advance of the excavation and request line locates.

No excavation shall take place on City Right-of-Way prior to approval by City.

The amount of trench excavation to grade shall not exceed 100 (one hundred) feet from the end of the pipe laying operations and no excavation shall be 300 (three hundred) feet in advance of the completed pipe operations (includes backfilling). At the end of the workday, all trench excavation shall be backfilled or surrounded with substantial chain-link fencing at least 6 (six) feet in height, attached to steel poles that are firmly anchored into the ground. Any landscaping, irrigation system, paving or utility that is disturbed, removed, or damaged during construction shall be replaced to original condition or better by the contractor.

Minimum bury depth: Minimum bury depth shall be forty-eight (48) inches from finished grade to the top of the pipe or as directed by the Owner.

Backfill Compaction:

Mechanical Method: Compaction and consolidation of the backfill materials shall be backfilled using the native material free of tree roots, large rocks and other deleterious materials, and compacted to 95 percent of maximum density as determined by ASTM D698 in six (6) inch lifts at optimum moisture content (to plus 4 percent above optimum moisture content) in areas subject to vehicular traffic, within 5 feet of and inside building footprints and other paved areas, and in ten (10) inch lifts in any other areas not specified. Where subject to vehicular traffic,

within 5 feet of or inside the building footprint and other paved areas, density tests shall be performed at the rate of one test per 300 LF per one foot of trench depth.  
Water Jetting Method: Water jetting is not allowed.

**END OF SECTION**

## Fire Protection Sprinkler System

### UNIVERSITY OF NORTH TEXAS SYSTEM

### FIRE PROTECTION SPRINKLER SYSTEMS

#### SECTION \_\_\_\_\_

#### **PART 1 - GENERAL**

##### 1.1 RELATED DOCUMENTS

- A. Drawings and general provisions of the Contract, including General and Supplemental Conditions and other Division 1 Specification Sections apply to this Section

##### 1.2 SUMMARY

- A. Section includes labor and materials for the installation of a hydraulically calculated, automatic fire sprinkler system(s), complete in all respects and ready for operation.
  - 1. Work includes the design of a hydraulically calculated, wet-pipe, automatic sprinkler system, designed for 100% coverage of the building.
  - 2. In areas where ambient temperature cannot be maintained at 40° or above, a dry pipe sprinkler system or a monitored heat tape system shall be provided.
  - 3. Design and installation of the sprinkler system shall be such that no parts interfere with general construction, doors, windows, heating, plumbing, air conditioning systems or electrical equipment.
- B. System components for each zone shall include, but not be limited to:
  - 1. Zone control valve and test/drain assembly.
  - 2. Drain valve.
  - 3. Waterflow switches.
  - 4. Valve supervisory switches.
  - 5. Piping.
  - 6. Sprinkler heads.

##### 1.3 SYSTEM DESCRIPTION

- A. The sprinkler system shall be an automatic fire sprinkler system supplied by a pressurized water supply (Municipal water main) to fusible sprinkler heads for the control of fire.
- B. The sprinkler system shall be hydraulically designed to meet the more stringent of the requirements of the 2013 Edition of NFPA 13.
- C. Work shall be installed in accordance with NFPA 13 and Owner's direction. Devices and equipment shall be listed by Underwriters' Laboratories, Inc. or Factory Mutual-approved, individually and as a system, as applicable.
- D. Coordinate the location of sprinkler heads and piping such that it does not interfere with the installed ceiling configuration or other building construction and equipment. Locate heads in center of ceiling tiles and/or as directed by the owner or architect.

##### 1.4 HYDRAULIC CALCULATIONS

- A. Prepare hydraulic calculations in accordance with NFPA 13 and with the following exceptions:
  - 1. Provide a minimum safety factor of 10 psi on all hydraulically calculated sprinkler systems.
- B. Hydraulic calculations shall be performed by a State of Texas Licensed Responsible Managing Employee (RME) in the direct employ of the fire protection contractor, or by a Texas State Registered Professional Engineer (P.E.).
- C. A recent fire flow test shall be the basis for the fire sprinkler design.

##### 1.5 SUBMITTALS

- A. Contractor's Qualification Data: Copies of fire sprinkler firm's TDI registration, RME-G License and TDI required liability insurance.
- B. Product Data: For each type of product indicated.

September 30, 2024

Page **176** of **303**



- C. Shop Drawings: Submit 3 (three) full-size sets of shop drawings for review. Plans must include the following:
1. A "Wet" RME or Texas Professional Engineer's signature and stamp, is required on all plan drawings and calculations.
  2. Plans shall be clear and legible and all sheets shall be in a common and appropriate scale;
  3. The following information shall be provided on the plans:
    - a. Site plan showing location of the building, all fire hydrants, fire lanes, fire department connections and the fire service main location.
    - b. Scale.
    - c. Floor plan.
    - d. Square footage.
    - e. Location of doors.
    - f. Intended use of each room is identified.
    - g. North arrow provided.
    - h. Location of the Fire Department Connection (FDC).
    - i. Occupancy classification.
    - j. Scope of Work.
    - k. Equipment List.
    - l. Hydraulic calculations for each design area.
    - m. A complete full-height cross section of the building.
    - n. Area of coverage of each sprinkler head.
    - o. Total area protected by each system.
    - p. Capacity of the dry system or antifreeze system.
    - q. Hydraulic node symbols and schedule.
    - r. Indicate all Riser Nipples (RN) or Drop Nipples (DN).
    - s. Elevations of sprinkler lines and node points.
    - t. Hanger details.
    - u. Hanger locations.
    - v. Sprinkler riser diagram.
    - w. Inspectors test connection detail.
    - x. Auxiliary drain details.
    - y. Size and location of standpipe hose stations, if applicable.
    - z. Description of the design area.
    - aa. Design density of each design area.
    - bb. Clearly indicate each remote area.
      - cc. Provide graphic representation of the waterflow analysis.
      - dd. Provide the water supply test information.
      - ee. Provide notes to indicate the following;
      - ff. Design code.
      - gg. Responsible party with regards to freeze protection. If to be provided by others, indicate and provide drawings to indicate the heaters with your submittal.
  4. The title block shall contain the following;
    - a. Location of the installation.
    - b. Name and complete address of the business.
    - c. Name and complete address of the installing company.
    - d. Licensing information.
    - e. Date.
    - f. Drawn by.
  5. A legend shall be provided to include:
    - a. Symbol, sprinkler description, manufacturer, model number, and quantity for each device.
    - b. Pipe and fittings type.
- D. Submit 3 (three) copies of equipment specification booklets containing all materials, equipment and products that are being provided for installation.
1. Materials, equipment and products being used shall be identified in the specification booklets by an arrow

- or highlighter.
- E. Field test reports and certifications for compliance with performance requirements shall be submitted to the owner. Include "Contractor's Material and Test Certificate for Aboveground Piping"
- F. All fire system submittals shall be provided to the UNTS Fire Marshal for review and approval prior to any work.
- G. Approved Sprinkler Piping Drawings: Working plans, prepared according to NFPA 13, that have been approved by authorities having jurisdiction including hydraulic calculations
- H. Welding certificates.
- I. Field Test Reports and Certificates: Indicate and interpret test results for compliance with performance requirements and as described in NFPA 13, Include "Contractor's Material and Test Certificate for Aboveground Piping."
- J. Field quality-control reports.
- K. Operation and maintenance data.
  - L. Submit complete "As-Built" set of plans for each fire sprinkler and standpipe system.

#### 1.6 QUALITY ASSURANCE

- A. Installer Qualifications: Specialist Firm -- The installing contractor shall specialize in the design and installation of fire sprinkler systems and shall be registered as a fire sprinkler contractor by the Texas State Board of Insurance Underwriters (TDI) and shall have in its employ, a Responsible Managing Employee (RME), licensed by the Texas State Board of Insurance Underwriters (TDI). The contractor shall have a minimum of three years of verifiable installation experience with fire sprinkler systems.
  - 1. Installer's responsibilities include designing, fabricating, and installing sprinkler systems and providing professional engineering services where needed to assume engineering responsibility. Base calculations on results of fire-hydrant flow test performed within past 90 days or less of design.
- B. Welding Qualifications: Qualify procedures and operators according to ASME Boiler and Pressure Vessel Code.
- C. Electrical Components, Devices, and Accessories: Listed and labeled as defined in NFPA 70, by a qualified testing agency, and marked for intended location and application.
- D. NFPA Standards: Sprinkler system equipment, specialties, accessories, installation, and testing shall comply with 2013 Edition of NFPA 13.

#### 1.7 PIPING AND FITTINGS

- A. Piping and fittings:
  - 1. All exposed, aboveground piping shall be minimum schedule 40 steel pipe\*, no exception, conforming to ASTM A53 or ASTM A795, Type E, Grade A. Comply with applicable governing regulations and industry standards.
  - 2. Piping and fittings for the fire main installed between the City's water utility connection and the required backflow prevention device for the fire riser shall be ASTM approved materials for potable water systems.
  - 3. The piping system for a dry pipe system shall be schedule 40 galvanized steel.
- B. \*Pipe and fittings shall be domestically manufactured by one of the manufacturers listed in the latest edition of the American Petroleum Institute (API) approved manufacturers listing.
- C. Threaded Fittings: Class 150 malleable iron, ANSI B16.3, for pipe sizes 2-inch and less.
- D. Malleable Iron Threaded Unions: ANSI B16.3, select for proper piping fabrication and service requirements including style, end connections, and metal-to-metal seats (iron, bronze, or brass), plain or galvanized as specified.
- E. Threaded Pipe Plugs: ANSI B16.14.
- F. Steel Flanges/Fittings: ANSI B16.5, including bolting, gasketing, and butt weld end connections. Fittings same thickness as pipe.
- G. Forged Steel Socket-welding and Threaded Fittings: ANSI B16.11, rated to match schedule of connected pipe.
- H. Wrought Steel Butt-welding Fittings: ANSI B16.9, except ANSI B16.28 for short radius elbows and returns; rated to match connected pipe.
- I. Flanged Fittings: Comply with ANSI B16.5 for bolt-hole dimensioning, materials, and flange thickness.

- J. Flange Bolts: Bolts shall be carbon steel ASTM A307 Grade A hexagon head bolts and hexagonal nuts. Where one or both flanges are cast iron, furnish Grade B bolts. Cap screws utilized with flanged butterfly valves shall be ASTM A307 Grade B with hexagon heads.
- K. Flange Bolt Thread Lubricant: Lubricant shall be an anti-seize compound designed for temperatures up to 1000°F and shall be Crane Anti-Seize Thread Compound or approved equal.
- L. Saddle tap fitting are not allowed.

#### 1.8 MISCELLANEOUS PIPING MATERIALS/PRODUCTS

- A. Welding Materials: Comply with ASME Boiler and Pressure Vessels Code, Section 11, Part C, for welding materials.
  - 1. Brazing Materials: American Welding Society, AWS A5.B, Classification B Cup-5.
- B. Gaskets for Flanged Joints: 1/16 inch thick for pipe size 10 inches and smaller and 1/8 inch thick for all pipe size 12 inches and larger. Ringtype shall be used between raised face flanges and full face-type between flat face flanges with punched bolt holes and pipe opening. Gaskets shall be Garlock Style 3400 compressed non-asbestos or equal.
- C. Dielectric Unions: Provide dielectric unions at all pipe connections between ferrous and nonferrous piping. Unions shall be "Delvin" as made by Pipeline Seal and Insulator Company or "EPCO" as made by Epco Sales, Inc. and shall have nylon insulation.
- D. Mechanical couplings may only be used for pipe sizes over 2-inch, to engage and lock grooved or pipe ends and to allow for some angular deflection, contraction and expansion.
  - 1. Couplings shall be positive lock type and shall consist of ASTM A536 ductile iron housing, c-shaped composition sealing gasket and carbon steel bolts conforming to ASTM A183.
  - 2. Gasket Material for wet systems shall be EPDM.
  - 3. Gasket material for dry pipe systems shall be silicone.
  - 4. All couplings shall be UL listed and approved.
  - 5. Provide only full flow (no-fabricated) fittings. Snap joint couplings, outlet couplings, cut-in style couplings, reducing couplings, mechanical-T style couplings, pressfit couplings, and plain end type couplings are not allowed.
  - 6. When mechanical couplings are used, ONLY grooved type fittings and pipe shall be used, no plain end fittings or pipe. Grooved couplings and fittings shall be manufactured by Victaulic, "Firelock" or approved equivalent.
- E. Water Flow Switches: Viking or approved equal water flow switch with adjustable retard feature. Switch shall be double-pole double-throw type and shall be rated at least 7 amperes at 125/250 volts.
- F. Valve Supervisory Switches:
  - 1. Provide on each valve, controlling or shutting-off sprinkler system where shown on drawings or/and on all valves required by NFPA 13, or any portion thereof.
  - 2. Provide UL listed unit, with either one single pole double throw switch or two single pole double throw switches as required. Switch shall be compatible with installed valve for standard mounting. Manufactured by Potter Roemer No. 6220, or approved equal.
- G. Sight Flow Connection: Provide acrylic sight flow connection in all test lines, conforming to NFPA 13.
- H. Pressure Gauges: Potter-Roemer Fig. No. 6240 or approved equal 3-1/2-inch diameter polished brass case, 1/4-inch NPT male connection, glass enclosed, 0-300 psi dial pressure gauges with isolation valves.
- I. All hangers and supports shall comply with NFPA 13.
- J. Fire Valve Cabinet (FVC): Where required, Potter-Roemer Fig. No. 18210, recessed fire valve cabinet consisting of 20-gauge steel cabinet with continuous hinge, re-coatable white polyester finish.
- K. Fire Department Valve (FDV): Where required, provide Potter Roemer No. 4060-D, UL Listed and FM approved 2-1/2" cast-brass angle valve with iron hand-wheel, female inlet by 2-1/2" male NST hose thread outlet, 300-pound rating, with female NST hose thread cap with pin lugs and chain.
- L. Wall Mounted Fire Department Siamese Connection: Potter Roemer No. 5785-C or approved equal, free standing, cast bronze body, with 2-1/2", UL listed, rough chrome plated body with polished chrome plated trim, caps and chains with NST hose threads.
- M. Remote Located Fire Department Connection: Where required by Owner, install free standing Potter Roemer No. 5761-5764 Body, cast bronze body with Siamese NST 2-1/2" outlets with polished chrome

- plated finish, with caps and chains, with NST threads.
- N. Roof Manifold: Where required, provide free standing Potter Roemer No. 5882 Body with 4065 Valves or approved equal, cast bronze body with 2-1/2" outlets with cast brass angle hose valves rated for 300 psi with polished chrome plated finish, with caps and chains, with NST threads.
  - O. Post Indicator Valve: Where required, provide adjustable, free standing indicating post and valve, consisting of UL/ FM approved non-rising stem gate valve and indicating post. Gate valve shall have iron body with non-rising stem, bronze mounted, indicator post flange, 175 psi non-shock rating, flanged ends. Indicator post shall be free standing and shall have a cast iron body, plexiglass window and an 18-inch adjustment span with handle and locked and chained in open position. Manufactured by Mueller Valve No. A-2052 and Indicating Post No. A-20801, or approved equal.

## **PART 2 - PRODUCTS**

### **2.1 SPRINKLERS**

- A. Unless otherwise specified, sprinkler heads shall be a quick response type with standard (155°F) temperature rated fusible link, 1/2-inch orifice and a 5.6 K factor.
  - 1. Heads located within the air streams of heat emitting equipment, elevator shafts, boiler rooms and similar areas shall have an intermediate (200°F) temperature rated fusible link.
  - 2. Install corrosion-resistant sprinkler heads where they are exposed to weather, moisture, or corrosive vapors.
  - 3. Heads installed where they might receive mechanical injury or are less than 7 feet above the floor level shall be protected with approved guards in accordance with NFPA 13.
  - 4. Sprinklers in areas with suspended ceilings shall have pipe and fittings located above the suspended ceiling.
- C. Sprinkler heads shall be UL Listed and approved:
  - 1. TYCO
  - 2. VIKING
  - 3. RELIABLE
- D. Provide metal cabinet containing a stock of spare sprinkler heads of all types and ratings installed per NFPA 13.
  - 1. Locate cabinet where temperature will not exceed 100°F.
  - 2. Location shall be approved by the Owner.
  - 3. Number of spare sprinklers shall conform to NFPA 13.
  - 4. Provide a sprinkler wrench in the cabinet, for each different type sprinkler head.
- E. The use of extended coverage type heads must have prior approval.
- F. The use of UL listed flexible type head assemblies are permitted.

### **2.2 VALVE SUPERVISORY SWITCHES**

- A. Contractor shall furnish and install supervisory switches. Coordinate wiring of switches with Electrical Contractor.

### **2.3 WATERFLOW SWITCHES**

- A. Provide Viking VSR-F or equivalent waterflow switches, with adjustable retard feature in the supply pipe to each zone for remote alarm. Switch shall be double-pole single-throw type and shall be rated at least 7 amperes at 125/250 volts.
- B. Waterflow switches shall be furnished and installed by this Contractor and wired by Fire Alarm or Electrical Contractor. Coordinate wiring of flow switches with appropriate contractor.

### **2.4 BUILDING FIRE ALARM SYSTEM INTERFACE**

- A. Each zone control assembly shall provide an alarm signal output to the Building Fire Alarm System whenever there is waterflow in the zone. Coordinate with Fire Alarm Contractor.
- B. Each valve which controls the flow of sprinkler system water shall be monitored by the Building Fire Alarm System. Coordinate with Fire Alarm Contractor.

### **2.5 SPRINKLER ALARM CHECK VALVE ASSEMBLY**

- A. Provide 175 psi rated automatic sprinkler valve with one or two pole (as required) flow detectors,

pressure switch and associated trim for a complete working system.

B. Provide products manufactured by Reliable, Viking or approved equivalent.

#### 2.6 SPRINKLER INSPECTOR'S TEST ASSEMBLY

A. Provide NFPA 13 compliant UL Listed and approved sprinkler system inspector's test assembly, consisting of sight glass, tamper resistant test orifice, test and drain ball valve, rated for 300 psi, manufactured by AGF Model 1000, or approved equal.

#### 2.7 PIPING EXTENDED FROM UNDERGROUND RISER THAT IS NOT CONNECTED TO A BACKFLOW PREVENTION DEVICE

A. Aboveground extension to backflow prevention device

1. Where the underground fire service pipe emerges from below grade and does not immediately terminate with a control valve and backflow prevention device (double check valve assembly) in a readily accessible location, the above-ground extension of the fire service pipe shall be connected to AWWA approved galvanized or stainless-steel pipe run to the control valve and backflow prevention device located in a readily accessible location.

#### 2.8 FREEZE PROTECTION FOR SPRINKLER PIPE SYSTEM

A. Fire protection piping within unheated crawl spaces and attics shall be protected from freezing by one of the following methods:

1. Raychem XL-Trace®, or equivalent, listed and supervised thermostatically controlled heat-trace tape, capable of maintaining pipe temperature above 40° F., shall be installed along the pipe system and sprinkler heads per manufacturer's installation instructions; pipe shall also be insulated with minimum 1-inch-thick Pittsburg Corning Foamglas®, John Manville Mico-Lok® Fiber Glass Pipe Insulation, or approved equivalent, type insulation. Where insulation is subject to damage, a metal outer jacket shall be installed over the insulation. The heat-trace tape electrical power source shall be monitored by the fire alarm panel.
2. Provide a dry pipe sprinkler system with all necessary components to protect the sprinkler system pipe and heads located in the unheated space.
  - a. Dry sprinkler pipe to be schedule 40 galvanized steel pipe conforming to ASTM A53 or ASTM A795, Type E, Grade A.
  - b. Components shall be rated for a minimum 175 psi working pressure.
  - c. Dry Pipe Valve. Provide UL listed and FM approved externally resettable dry pipe valve (Viking, or approved equal) and appurtenances. Equip and connect as required by NFPA 13.
  - d. Provide water and air pressure gauges, priming water level indicator, alarm test bypass and accelerator. Include all necessary pipe fittings and accessories to provide a complete dry pipe Sprinkler System.
  - e. Provide air maintenance devices consisting of air relief valve, bypass valve, shut-off valves; low and high air pressure supervisory switches and water flow supervisory switch with 120-volt single phase power requirement and adjustable pressure rating of 14 to 60 psi, manufactured by Reliable or approved equal.
  - f. Provide a quick opening device equipped with an anti-flooding device (Viking or approved equal) for each system riser.
  - g. Provide an oil-free air compressor for dry pipe sprinkler system applications, permanently lubricated, direct drive, air filter, safety relief valve set at 50 psi, UL listed, sized to fill dry system within 30 seconds. Air compressor shall be either pipe mounted or floor mounted. Manufactured by Reliable or approved equal.

### PART 3 - EXECUTION

#### 3.1 PIPING INSTALLATION

A. Locations and Arrangements: Drawing plans, schematics, and diagrams indicate general location and arrangement of piping. Install piping as indicated, as far as practical.

1. Deviations from approved working plans for piping require written approval from authorities having jurisdiction.

- B. Piping Standard: Comply with requirements for installation of sprinkler piping in NFPA 13.
- C. Piping and joints shall be full bore reamed, for all joint types.
- D. Slag shall be removed and cleaned at all welded joints.
- E. Use listed fittings to make changes in direction, branch takeoffs from mains, and reductions in pipe sizes.
- F. Install unions adjacent to each valve in pipes NPS 2" and smaller.
- G. Install flanges, flange adapters, or couplings for grooved-end piping on valves, apparatus, and equipment having NPS 2-1/2 and larger end connections.
- H. Install "Inspector's Test Connections" in sprinkler system piping, complete with shutoff valve, and sized and located according to NFPA 13.
- I. Install sprinkler piping with drains for complete system drainage.
- J. Install sprinkler control valves, test assemblies, and drain risers adjacent to standpipes when sprinkler piping is connected to standpipes.
- K. Install automatic (ball drip) drain valve at each check valve for fire-department connection, to drain piping between fire-department connection and check valve. Install drain piping to and spill over floor drain or to outside building.
- L. Install hangers and supports for sprinkler system piping according to NFPA13. Comply with requirements for hanger materials in NFPA 13.
- M. Install pressure gages on riser or feed main, at each sprinkler test connection, and at top of each standpipe. Include pressure gages with connection not less than NPS 1/4 and with soft metal seated globe valve, arranged for draining pipe between gage and valve. Install gages to permit removal, and install where they will not be subject to freezing.
- N. Fill sprinkler system piping completely with water.

### 3.2 PIPING INSTALLATION

- A. Piping shall be concealed, except by prior approval of Owner. Install all piping parallel to or at right angles to the column lines of the building wherever possible.
- B. Individual sprinkler head piping shall not connect to piping from the bottom of cross-main or branch lines.
- C. In electrical rooms, only sprinkler piping which serves the sprinkler heads in that room are allowed.
- D. Wet sprinklers shall not be located in rooms containing IT servers or elevator equipment rooms.
- E. Grade piping to eliminate traps and pockets and for drainage per NFPA 13. Where air pockets or water traps cannot be avoided, provide gate valves with hose connections for drainage.
- F. It shall be the responsibility of the Fire Protection Contractor to coordinate electrical equipment locations with the Electrical Contractor and design the fire protection piping system such that no piping is routed over electrical equipment, unless it serves that room.
- G. Changes in direction, branches, offsets etc., shall be made with standard pipe fittings. Holes in the main for branches shall be made with a hole-cutting machine and a standard "Weld-O-Let" or "Thread-O-Let" fitting used. Burning holes in the fire protection System Piping will cause that section of the piping to be cut out and replaced at the Contractor's expense.
- H. Pipe shall be reamed to full pipe diameter before joining:
  - 1. Screwed joints shall be made with standard pipe thread and an approved compound applied to the male thread only.
  - 2. Welded joints shall be made in accordance with the procedure outlined in the ANSI piping code.
  - 3. Valves and specialties shall be screwed or flanged joints.
  - 4. Grooved joints shall be made in accordance with manufacturers recommendations with UL listed and approved couplings or weld-o-let connections to pipe mains shall be full bore.
  - 5. Slag, etc. shall be removed.
- I. Install unions or flanges at equipment connections and as indicated on the Drawings.
- J. Cold-springing piping will not be permitted. Install piping with adequate support to prevent strain on the equipment and to allow for piping system expansion and contraction.
- K. Welded joints on pipe runs shall be made with continuous welds and with pipe ends beveled before fabrication. Piping shall be carefully aligned prior to welding and no metal shall project within the pipe.
- L. Piping shall be sized as required by applicable codes and as indicated on the Drawings.

- M. Provide all test and drain lines as required by NFPA 13.
1. Pressure gauges, signs, and other such standard appurtenances shall be furnished as required for a complete installation in accordance with NFPA 13.
  2. Provide nameplate data sign at the zone controlling valve to identify the system as a hydraulically designed system indicating the location and basis for design in accordance with NFPA 13.
  3. Install sprinkler piping so that it can be thoroughly drained, and where practicable shall be arranged to drain at the zone drain valve. The zone drain valve shall be capable of a full discharge test without allowing water to flow onto the floor. All drips and drains shall conform to NFPA 13.
  4. Field changes in the piping layout or pipe sizes shall not be made without the prior approval of the Owner.

### 3.2 CUTTING AND PATCHING

- A. General: Cut and patch walls, floors, etc., resulting from work or by failure to provide proper openings or recesses in new construction.
- B. Methods of Cutting:
1. Openings cut through concrete and masonry shall be made with masonry saws and/or core drills and at such locations acceptable to the Owner.
  2. Impact-type equipment shall not be used except where specifically acceptable to the Owner.
  3. Openings in precast concrete slabs for pipes, conduits, outlet boxes, etc., shall be core drilled to exact size.
- C. Fire Stopping:
1. Holes and penetrations through smoke barriers, fire barriers, fire walls or any other fire rated assembly shall be installed and sealed using an approved U.L. listed assembly. Materials used for fire sealing / draft stopping shall be compatible with the fire sprinkler piping material. A factory certified fire seal contractor shall install and seal these penetrations.
- D. Restoration:
1. All openings shall be restored to "as-new" condition for the materials involved, and shall match remaining surrounding materials and/or finishes.
- E. Masonry:
1. Where openings are cut through masonry walls, provide and install lintels or other structural supports to protect the remaining masonry.
  2. Adequate supports shall be provided during the cutting operation to prevent any damage to the masonry occasioned by the operation.
  3. All structural members, supports, etc., shall be of the proper size and shape, and shall be installed in a manner acceptable to the Owner.
  4. Special Note: No cutting, boring, or excavating which will weaken the structure shall be undertaken. A Texas Registered Professional Engineer shall be consulted in these cases. Necessary structural repairs shall be designed by a Texas Registered Professional Engineer.

### 3.3 TESTS AND INSPECTIONS

- A. Inspections, examinations and tests required by the authorities or agencies specified shall be arranged and paid for by the Fire Protection Subcontractor, as necessary, to obtain complete and final acceptance of the system as installed. The certificates of inspection shall be in quadruplicate, and shall be delivered to the Owner.
- B. Fire protection piping systems shall be hydrostatically tested by the Contractor upon completion of the installation as required by NFPA 13 in the presence of the Owners Representative.
1. The fire protection piping systems shall be hydrostatically tested per the requirements listed in NFPA 13.
  2. When hydrostatic and alarm tests have been completed and all necessary corrections made, a material and test certification shall be provided in accordance with NFPA 13.
  3. Final inspection shall include full flow testing through the inspector's test connection.
  4. Actuation of the flow switch shall occur within one minute of opening of the inspector's test valve.
  5. Final tests shall be witnessed by the Owner's Representative.
- C. Sprinkler system zone control assemblies shall be tested to demonstrate proper operation of the flow

switch and valve supervisory switch.

- D. Arrange and pay for all tests and inspections required by authorities having jurisdiction.
- E. Sprinkler piping system will be considered defective if it does not pass tests and inspections.
- F. Prepare test and inspection reports.

### 3.3 JOINT CONSTRUCTION

- A. Install couplings, flanges, flanged fittings, unions, nipples, and transition and special fittings that have finish and pressure ratings same as or higher than system's pressure rating for aboveground applications unless otherwise indicated.
- B. Install unions adjacent to each valve in pipes NPS 2" and smaller.
- C. Install flanges, flange adapters, or couplings for grooved-end piping on valves, apparatus, and equipment having NPS 2-1/2" and larger end connections.
- D. Ream ends of pipes and tubes and remove burrs. Bevel plain ends of steel pipe.
- E. Remove scale, slag, dirt, and debris from inside and outside of pipes, tubes, and fittings before assembly.
- F. Flanged Joints: Select appropriate gasket material in size, type, and thickness suitable for water service. Join flanges with gasket and bolts according to ASME B31.9.
  
- G. Threaded Joints: Thread pipe with tapered pipe threads according to ASME B1.20.1. Cut threads full and clean using sharp dies. Ream threaded pipe ends to remove burrs and restore full ID. Join pipe fittings and valves as follows:
  - 1. Apply appropriate tape or thread compound to external pipe threads.
  - 2. Damaged Threads: Do not use pipe or pipe fittings with threads that are corroded or damaged.
- H. Welded Joints: Construct joints according to AWS D10.12M/D10.12, using qualified processes and welding operators according to "Quality Assurance" Article.
  - 1. Shop weld pipe joints where welded piping is indicated. Do not use welded joints for galvanized-steel pipe.
- I. Steel-Piping, Cut-Grooved Joints: Cut square-edge groove in end of pipe according to AWWA C606. Assemble coupling with housing, gasket, lubricant, and bolts. Join steel pipe and grooved-end fittings according to AWWA C606 for steel-pipe joints.
- J. Steel-Piping, Roll-Grooved Joints: Roll rounded-edge groove in end of pipe according to AWWA C606. Assemble coupling with housing, gasket, lubricant, and bolts. Join steel pipe and grooved-end fittings according to AWWA C606 for steel-pipe grooved joints.
- K. Dissimilar-Material Piping Joints: Make joints using adapters compatible with materials of both piping systems.

### 3.4 PERIODIC INSPECTION SERVICE

- A. After completion of the fire protection system installation and at the beginning of the guarantee period, the Automatic Sprinkler Subcontractor shall execute the National Automatic Sprinkler and Fire Control Association, Inc., Standard Form of "Inspection Agreement", without change in the Contract amount, calling for four inspections of the fire protection system during the warranty period.
- B. During the warranty period, inspections shall be in accordance with the Inspection Agreement, plus the following maintenance to be performed during the course of the fourth inspection:
  - 1. Operation of all control valves.
  - 2. Lubrication of operating stems of all interior valves.
  - 3. Operation of all alarms, supervisory switches, air compressors, alarm trip switches, flow switches, and similar items.
  - 4. Cleaning of alarm valves.
  - 5. Lubrication of Fire Department valve hose connections.
  - 6. The standard form of the National Automatic Sprinkler and Fire Control Association, Inc., "Report of Inspection", shall be filled out in triplicate after each inspection and the copies sent to the Owner.



### 3.4 VALVE AND SPECIALTIES INSTALLATION

- A. Install listed fire-protection valves, trim and drain valves, specialty valves and trim, controls, and specialties according to NFPA 13 and authorities having jurisdiction.
- B. Install listed fire-protection shutoff valves supervised open, located to control sources of water supply except from fire-department connections. Install permanent identification signs indicating portion of system controlled by each valve.
- C. Install check valve in each water-supply connection. Install double check, fire service rated backflow preventer in connection to potable-water-supply sources.
- D. Specialty Valves:
  - 1. General Requirements: Install in vertical position for proper direction of flow, in main supply to system.

### 3.5 IDENTIFICATION

- A. Install labeling and pipe markers on equipment and piping according to requirements in NFPA 13.

### 3.5 SPRINKLER AND COVER PLATE (RECESSED SPRINKLER HEADS) INSTALLATION

- A. Sprinkler heads and recessed sprinkler cover plates shall be protected from damage, dirt and other deleterious materials during construction. Remove and replace any damaged sprinkler or sprinkler cover plate, or sprinklers or cover plates having any foreign material other than factory finish. Sprinkler heads and cover plates shall not be cleaned unless by a method approved by the manufacturer AND accepted by the Owner.

### 3.6 ESCUTCHEON INSTALLATION

- A. Install escutcheons for penetrations of walls, ceilings, and floors.

### 3.7 SLEEVE INSTALLATION

- A. General Requirements: Install sleeves for pipes and tubes passing through penetrations in floors, partitions, roofs, and walls.
- B. Sleeves are not required for core-drilled holes.
- C. Permanent sleeves are not required for holes formed by removable PE sleeves
- D. Cut sleeves to length for mounting flush with both surfaces unless otherwise indicated.
- E. Install sleeves in new partitions, slabs, and walls as they are built.
- F. For interior wall penetrations, seal annular space between sleeve and pipe or pipe insulation using joint sealants appropriate for size, depth, and location of joint.
- G. For exterior wall penetrations above grade, seal annular space between sleeve and pipe using joint sealants appropriate for size, depth, and location of joint.
- H. For exterior wall penetrations below grade, seal annular space between sleeve and pipe using sleeve seals.
- I. Seal space outside of sleeves in concrete slabs and walls with grout.
- J. Fire-Barrier Penetrations: Maintain indicated fire rating of walls, partitions, ceilings, and floors at pipe penetrations. Seal pipe penetrations with firestop materials.

### 3.8 SLEEVE SEAL INSTALLATION

- A. Install sleeve seals in sleeves in exterior concrete walls at water-service piping entries into building.
- B. Select type and number of sealing elements required for pipe material and size. Position pipe in center of sleeve. Assemble sleeve seal components and install in annular space between pipe and sleeve. Tighten bolts against pressure plates that cause sealing elements to expand and make watertight seal.

### 3.9 IDENTIFICATION

- A. Install labeling and pipe markers on equipment and piping according to requirements in NFPA 13.

### 3.10 FIELD QUALITY CONTROL

- A. Perform tests and inspections.

- B. Tests and Inspections:
  - 1. Leak Test: After installation, charge systems and test for leaks. Repair leaks and retest until no leaks exist.
  - 2. Test and adjust controls and safeties. Replace damaged and malfunctioning controls and equipment.
  - 3. Flush, test, and inspect sprinkler systems according to NFPA 13, "Systems Acceptance" Chapter.
  - 4. Energize circuits to electrical equipment and devices.
  - 5. Start and run excess-pressure pumps.
  - 6. Coordinate with fire-alarm tests. Operate as required.
  - 7. Verify that equipment hose threads are NST.
  - 8. Sprinkler system zone control assemblies shall be tested to demonstrate proper operation of the flow switch and valve supervisory switch.
  - 9. Arrange & pay for all tests and inspections required by authorities having jurisdiction.
- C. Sprinkler piping system will be considered defective if it does not pass tests and inspections.
- D. Prepare test and inspection reports.

### 3.11 PERIODIC INSPECTION SERVICE

- A. Provide periodic inspections service after completion and Owner acceptance.
- B. This agreement shall be executed at no cost to the Owner and shall include four inspections of the entire sprinkler system during the warranty period, each with a NASFCA "Report of Inspection to the Owner". The final inspection shall include operation and lubrication of all valves, cleaning of all alarm valves and operational testing of all system Electrical and alarm components.

### 3.12 TRAINING

- A. The installation contractor shall provide a minimum of 4 hours of training for the Owner in operation and maintenance of the wet-pipe and/or dry pipe sprinkler system.

**END OF SECTION**

## Fire Pumps

### UNIVERSITY OF NORTH TEXAS

#### FIRE PUMPS SECTION 21 30 00

#### **PART 1 - GENERAL**

##### 1.1 SUMMARY

A. This section addresses electric fire pump motors, fire and jockey pumps, respective related controllers and specialty accessories incorporated into a building fire sprinkler system.

##### 1.2 SUBMITTALS

- A. Product Data: For each type of product indicated.
- B. Shop Drawings: For fire pumps, motor drivers, and fire-pump accessories and specialties. Include plans, elevations, sections, details, and attachments to other work.
1. Fire and jockey pump cut sheets with all pump capacities, UL/FM approval, pump characteristics, features and accessories clearly indicated. Include pump motor brand name and performance data.
  2. Pump curves with selection point clearly indicated.
  3. Fire and jockey pump motors must be listed for fire pump use and meet NFPA 20 standards. Provide Totally Enclosed, Fan Cooled (TEFC) fire pump motors. Provide complete motor specifications and data.
    - a. U.S. Motor is not an acceptable motor manufacturer for fire pump motors.
  4. Fire Pump Controller Automatic Transfer Switch and cut sheets with features and options clearly indicated, wiring diagrams, nameplate text and a written system operational sequence.
  5. Jockey pump controller wiring diagram.
- C. Product Certificates: For each fire pump, from manufacturer.
- D. Source quality-control reports.
- E. Field quality-control reports.
- F. Operation and maintenance data.

##### 1.3 QUALITY ASSURANCE

A. Electrical Components, Devices, and Accessories: Listed and labeled as defined in NFPA 70, by a qualified testing agency, and marked for intended location and application.

- B. NFPA Compliance: Comply with NFPA 20, "Installation of Stationary Pumps for Fire Protection."

#### 1.4 DELIVERY, STORAGE, AND HANDLING

- A. Deliver pumps, controllers, automatic transfer switch, and accessories in factory-fabricate water resistant wrapping.
- B. Handle pumps, controllers, automatic transfer switch, and accessories carefully to avoid damage to material components, enclosure, and finish.
- C. Store pumps, controllers, automatic transfer switch, and accessories in a clean, dry space and protect from the weather.

#### 1.5 COORDINATION

- A. Coordinate sizes and locations of concrete bases with actual equipment provided.

### **PART 2 - PRODUCTS**

#### 2.1 MANUFACTURERS

- A. Manufacturers: Subject to compliance with requirements, provide products by one of the following:
  - 1. Fire Pump:
    - a. S.A. Armstrong Limited.
    - b. A-C Fire Pump Systems; a business of ITT Industries.
    - c. Aurora.
    - d. Peerless Pump, Inc.
    - e. Patterson Pump Company; a subsidiary of the Gorman-Rupp Company.
  - 2. Electric Fire Pump Motor:
    - a. Lincoln
    - b. WEG
    - c. Marathon
  - 3. Jockey Pump:
    - a. Grundfos.
    - b. Goulds.
    - c. S.A. Armstrong Limited.
  - 4. Fire Pump & Jockey pump Controllers:

- a. Torna Tech (preferred)
- b. Metron.
- c. Master.
- d. Firetrol, Inc.

## 2.2 ELECTRIC FIRE PUMP SYSTEM

### A. General:

1. Provide a complete and operational fire pumping system consisting of horizontal split case electric fire pump, jockey pump, combination fire pump controller/automatic transfer switch, jockey pump controller, flow testing equipment and associated components as specified and as scheduled and shown on Drawings.
2. Equipment furnished and the complete installation shall be in accordance with NFPA 20. Pump and controller/automatic transfer switch shall bear the UL label.
3. Refer to schedule on Drawings for pump size and design characteristics. Size of the fire pump is to be based on flow test information.

### B. Fire Pump:

1. Electric driven fire pump shall be a horizontal split case centrifugal type, UL Listed, FM-approved and in compliance with all requirements of NFPA 20.
2. Pump shall be of bronze-fitted construction with Class 30 cast iron casing, bronze impeller, renewable bronze sleeves and bronze wear rings, packed stuffing boxes and grease lubricated ball bearings in motor.
3. Pump shaft shall be high strength steel.
4. Pump shaft deflection shall not exceed 0.002 inch at the stuffing boxes when operating at  $\pm 25$  percent of the best operating point.

### C. Pump suction flange shall be rated for 125 psi working pressure on inlet side and the discharge flange shall be rated for 250 psi working pressure.

1. Fire pump shall be factory mounted on a pedestal and connected through a rigid split coupling. Motor shall have a 1.15 service factor shall be sized so as to not exceed the permissible loading limits of NFPA 20 at any point on the pump performance curve.
2. Locked rotor current shall not exceed the values specified in NFPA 20.

3. Each motor shall be of such capacity that at rated voltage under any pump operating condition, the full load ampere rating shall not be exceeded except as permitted by the service factor stamped on the motor nameplate.
  4. Motors shall be compatible with the specified motor controller.
  5. Motor electrical characteristics and capacity shall be as scheduled and shown on the Drawings.
- D. Fire pump capacity shall be as scheduled on Drawings.
- E. Pump shall be hydrostatically tested at 1.5 times the maximum working pressure but in no case less than 250 psi.
- F. Shutoff head of fire pump must exceed dead head of fire pump by 10 psi.
- G. Accessories:
1. Provide pump accessories per NFPA 20, including, but not limited to:
    - a. 3/4" minimum casing overheat relief.
    - b. 3-1/2" dial liquid filled compound suction pressure gauge.
    - c. 3-1/2" dial liquid filled discharge pressure gauge.
    - d. Eccentric tapered suction reducer.
    - e. Concentric tapered discharge increaser.
    - f. Base-mounted coupling guard.
    - g. Fire pump accessories shall be approved for domestic water use.
    - h. All relief drains to floor drains.
- H. Factory Testing: Fire pump shall be factory tested and certified in accordance with NFPA 20. Certified performance test results and curves shall be delivered to the Owner for review prior to final fire pump acceptance.
- I. Field Service: Pump supplier shall provide pump checkout, start-up, testing and adjusting of system components and shall perform field certification testing on the installed fire pump. The pump supplier shall also train the Owners Engineer in the proper operation and maintenance of the fire pump system.

### 2.3 FIRE PUMP CONTROLLER/AUTOMATIC TRANSFER SWITCH

- A. The fire pump controller/automatic transfer switch shall be of the combined manual and automatic type, solid state reduced voltage, minimum, 100,000 amp withstand rated, full service, and UL listed

and FM approved per NFPA 20 currently enforced. The fire pump controller/automatic transfer switch shall be housed in a NEMA 2 floor-mounted, non-vented enclosure, mounted on a 4" thick concrete pad, and include the following:

1. Isolation switch with a separate NEMA operating handle interlocked with circuit breaker.
2. Time delay circuit breaker set at 300 percent motor full load current with external LED supervised locked rotor protector, instant and time delay trip test switch, and external NEMA operator handle.
3. Differential adjustable pressure switch with energize to start relay.
4. Minimum run timer, 10 minutes non-adjustable, with timed out LED indicator.
5. POWER AVAILABLE and PHASE REVERSAL pilot lights wired to the line side of the motor starter. Indicating lights shall be long life LEDs.
6. Digital ammeter and voltmeter with three phase selector switch, calibrated traceable to NBS standards.
7. Built in alarm panel and supervisory power pilot light powered from separate reliable 120 VAC power source with lights, bell, silence button, and lamp test switch for indication of PUMP RUNNING, POWER FAILURE, PHASE REVERSAL, TRANSFER SWITCH IN EMERGENCY, ISOLATION SWITCH OPEN. A status panel for start and run demands shall also be included. All indicating lights shall be long life LEDs with lamp test feature.
8. START and STOP pushbuttons for manual control.
9. Two sets each of dry form "C" contacts for remote indication at main fire alarm panel for PUMP RUNNING, POWER FAILURE, PHASE REVERSAL, TRANSFER SWITCH IN EMERGENCY, ISOLATION SWITCH OPEN, and SUPERVISORY POWER FAILURE.
10. Digital paperless alarm recorder.
11. Three non-fused control power transformers, surge protector wired to the load side of the isolation switch with short circuit protection, magnetic contactors with externally operable mechanical start mechanism, and restart delay timer.
12. Automatic transfer switch housed in a separate compartment of the fire pump controller. The transfer switch shall have normal power light and monitors, emergency power light and monitor, test switch, and time delays for generator start, transfer to emergency, and retransfer to normal. All control and monitor components shall be individually serviceable. Unit shall have, as a minimum, a 5-year warranty on parts and a 2-year warranty on labor.
13. The fire pump controller and transfer switch shall be for fire pump scheduled horsepower, UL 1008 listed, 3 phase motor, rating for highest low voltage (i.e., 208, 240, 460) available at site.

B. The fire pump controller/ATS shall also have the following control functions:

September 30, 2024

Page **191** of **303**

Appendix C: Fire Protection System Specifications  
UNT System Fire Marshall Fire Protection Standards

1. Provide an interlock between the fire pump controller and ATS that will, when the fire pump is running, inhibit the automatic transfer switch from "TRANSFERRING-TO-NORMAL" power source as long as the fire pump is operating on the "EMERGENCY" source.
2. Interlock control wiring from the Fire Pump Controller to the Fire Pump Automatic Transfer Switch shall be factory-installed.

#### 2.4 FIRE PUMP WIRE

- A. Electrical wiring for fire pump, jockey pump and associated controllers shall be installed by a Texas Department of Licensing and Regulations (TDLR) registered and licensed Electrical Contractor.
- B. Electrical supply conductors for the fire pump motor shall be sized according to NFPA 70 for Fire Pumps.
- C. Electrical feeder conductors for the fire pump motor shall be capable of maintaining integrity and operation for a minimum of two hours under fire exposure condition. Acceptable wire is as follows:
  1. Lifeline<sup>®</sup> Power Cable RHW-2 Two-Hour Fire Resistive Cable;
  2. VitaLink<sup>®</sup> MC Two Hour Fire Rated Power Cable.

#### 2.5 FLOW TESTING EQUIPMENT

- A. The fire pump supplier shall furnish a FM approved flow meter for testing the fire pump.
- B. The flow meter shall be flanged venturi type BV as manufactured by Aeroquip, or approved equal.
- C. The installing contractor shall submit approval drawings of the proposed piping layout, which shall conform to the requirements prescribed by the flow meter manufacturer.

#### 2.6 FIRE PUMP TEST HEADER

- A. Provide wall mounted ductile iron body outlet fire pump test connection, complete with polished chrome plated exposed surfaces, with plate lettered "Pump Test Connection".
- B. Chrome plated brass NRS hose gate valves, with loose bonnet caps and chains, 2-1/2 inch gate valves with local fire department threads, back outlet, manufactured by Potter Roemer No. 5864-D-2, or approved equal.

#### 2.7 JOCKEY PUMP

- A. General: Provide a complete and operational electric driven fire jockey pump and jockey pump controller as specified herein and as scheduled and as shown on the Drawings.
- B. Pump:



1. The jockey pump shall be a centrifugal multi-stage pump with stainless steel impeller and shaft, and cast-iron base, and EPDM O-rings.
  2. Jockey pump capacities shall be as scheduled on the Drawings.
  3. Pumps, casings, flanges, and mechanical seals shall be rated for operation with the working pressures scheduled.
- C. The jockey pump shall be mounted on a fabricated cast iron drip lip base and shall be close-coupled or flexible coupled to an energy efficient, high efficiency open drip-proof motor. Motor electrical characteristics and capacity shall be as scheduled or listed on the drawings.
  - D. Relief Valve: Provide the fire jockey pump with a factory-mounted bypass relief valve complete with piping. Set relief valve to relieve at a pressure of 25 psi above design total dynamic head to prevent motor overload and system damage.
  - E. Jockey Pump Controller: The electric jockey pump controller shall be UL listed and NFPA 70 compliant. Unit shall include a circuit breaker, magnetic starter with overloads, 0-300 psi pressure switch, H-O-A selector switch, minimum run timer, dual fused control transformer, two sets of remote form "C" contacts for pump running, and a NEMA 2 enclosure.
  - F. Field Service: The pump supplier shall provide pump checkout, start-up, testing and adjusting of system components and shall perform field certification testing on the installed jockey pump. The pump supplier shall also train the Owners Representatives in the proper operation and maintenance of the jockey pump system.

## 2.8 GROUT

- A. Standard: ASTM C 1107, Grade B, post-hardening and volume-adjusting, dry, hydraulic-cement grout.
- B. Characteristics: Nonshrink and recommended for interior and exterior applications.
- C. Design Mix: 5000-psi, 28-day compressive strength.
- D. Packaging: Premixed and factory packaged.

## 2.9 SOURCE QUALITY CONTROL

- A. Testing: Test and inspect fire pumps according to UL 448 requirements for "Operation Test" and "Manufacturing and Production Tests."
  1. Verification of Performance: Rate fire pumps according to UL 448.
- B. Fire pumps will be considered defective if they do not pass tests and inspections.
- C. Prepare test and inspection reports.

## PART 3 - EXECUTION

### 3.1 EXAMINATION

- A. Examine equipment bases and anchorage provisions, with Installer present, for compliance with requirements and for conditions affecting performance of fire pumps.
- B. Examine roughing-in for fire-suppression piping systems to verify actual locations of piping connections before fire-pump installation.
- C. Proceed with installation only after unsatisfactory conditions have been corrected.

### 3.2 INSTALLATION

- A. Fire-Pump Installation Standard: Comply with NFPA 20 for installation of fire pumps, relief valves, and related components.
- B. Equipment Mounting: Install fire pumps and jockey pumps on concrete bases.
  - 1. Where not otherwise indicated, install 4-inch-thick concrete foundation pads for indoor floor-mounted equipment, except where direct floor mounting is allowed by prior approval.
  - 2. For equipment mounted outdoors, provide concrete foundations a minimum of 6 inches above grade.
  - 3. Provide reinforcing steel as recommended by the structural engineer and as detailed on the Drawings.
  - 4. Pour pads on roughened floor slabs, sized so that outer edges extend a minimum of 3 inches beyond equipment. Trowel pads smooth and chamfer edges to a 1-inch bevel. Secure equipment to pads as recommended by the manufacturer.
  - 5. Anchor Bolts. Furnish and install galvanized anchor bolts for equipment placed on concrete equipment pads or on concrete slabs. Bolts shall be of the size and number recommended by the manufacturer of the equipment and shall be located by means of suitable templates. When equipment is placed on vibration isolators, the equipment shall be secured to the isolator and the isolator secured to the floor, pad, or support as recommended by the vibration isolation manufacturer.
    - a. Install dowel rods to connect concrete base to concrete floor. Unless otherwise indicated, install dowel rods on 18" centers around the full perimeter of concrete base.
    - b. For supported equipment, install epoxy-coated anchor bolts that extend through concrete base and anchor into structural concrete floor.
    - c. Place and secure anchorage devices. Use setting drawings, templates, diagrams, instructions, and directions furnished with items to be embedded.

- d. Install anchor bolts to elevations required for proper attachment to supported equipment.
- 6. Setting of Equipment. Provide permanent and temporary shoring, anchoring, and bracing required to make parts stable and rigid; even when such shoring, anchoring, and bracing are not explicitly called for.
  - a. Equipment must be leveled and set plumb.
- C. Install fire-pump suction and discharge piping equal to or larger than sizes required by NFPA 20.
- D. Support piping and pumps separately so weight of piping does not rest on pumps.
- E. Install valves that are same size as connecting piping.
- F. Install pressure gauges on fire-pump suction and discharge flange pressure-gauge tapings.
- G. Install piping hangers and supports, anchors, valves, gages, and equipment support according to NFPA 20.
- H. Electrical Wiring: Install electrical devices furnished by equipment manufacturers but not factory mounted. Furnish copies of manufacturers' wiring diagram submittals to Electrical Contractor.
- I. Wiring Method: Conceal conductors and cables in accessible ceilings, walls, and floors where possible.
- J. Engage a factory-authorized service representative to perform startup service.
- K. Complete installation and startup check according to manufacturer's written instructions.

### 3.3 ALIGNMENT

- A. Align split-case pump and driver shafts after complete unit has been leveled on concrete base, grout has set, and anchor bolts have been tightened.
- B. After alignment is correct, tighten anchor bolts evenly. Fill baseplate completely with grout, with metal blocks and shims or wedges in place. Tighten anchor bolts after grout has hardened. Check alignment and make required corrections.
- C. Align piping connections.
- D. Align pump and driver shafts for angular and parallel alignment and to tolerances specified by manufacturer.

### 3.4 CONNECTIONS

- A. Comply with requirements for piping and valves specified in Section 21 13 13, Wet-Pipe Sprinkler Systems. Drawings indicate general arrangement of piping, fittings, and specialties.

- B. Install piping adjacent to pumps and equipment to allow service and maintenance.
- C. Connect relief-valve discharge to drainage piping or point of discharge.
- D. Connect fire pumps to their controllers.

### 3.5 IDENTIFICATION

- A. Identify system components. Comply with requirements for fire-pump marking according to NFPA 20.

### 3.6 FIELD QUALITY CONTROL

- A. Test each fire pump with its controller as a unit.
- B. Manufacturer's Field Service: Engage a factory-authorized service representative to inspect, test, and adjust components, assemblies, and equipment installations, including connections.
- C. Perform tests and inspections.
  - 1. Manufacturer's Field Service: Engage a factory-authorized service representative to inspect components, assemblies, and equipment installations, including connections, and to assist in testing.
- D. Tests and Inspections:
  - 1. After installing components, assemblies, and equipment including controller, test for compliance with requirements.
  - 2. Test according to NFPA 20 for acceptance and performance testing.
  - 3. Leak Test: After installation, charge system and test for leaks. Repair leaks and retest until no leaks exist.
  - 4. Operational Test: After electrical circuitry has been energized, start units to confirm proper motor rotation and unit operation.
  - 5. Test and adjust controls and safeties. Replace damaged and malfunctioning controls and equipment.
  - 6. Components, assemblies, and equipment will be considered defective if they do not pass tests and inspections.
  - 7. Prepare test and inspection reports.
- E. Furnish fire hoses in number, size, and length required to reach storm drain or other acceptable location to dispose of fire-pump test water. Hoses are for tests only and do not convey to Owner.

### 3.7 DEMONSTRATION

- A. Engage a factory-authorized service representative to train Owner's maintenance personnel to adjust, operate, and maintain fire pumps. Coordinate training with Owner.
- B. Training of the Owner's operation and maintenance personnel is required in cooperation with the Owner's Representative. Provide competent, factory authorized personnel to provide instruction to operation and maintenance personnel concerning the location, operation, and troubleshooting of the installed systems. The instruction shall be scheduled in coordination with the Owner's Representative after submission and approval of formal training plans.

**END OF SECTION**

Fire Alarm System

**UNIVERSITY OF NORTH TEXAS SYSTEM**

**FIRE ALARM SYSTEM (ECS)  
SECTION \_\_\_\_\_**

**PART 1 - GENERAL**

1.1 GENERAL REQUIREMENTS

- A. The requirements of Division 1, General Requirements and other provisions of the contract documents apply to this work.
- B. The fire alarm system shall be an integrated fire detection and emergency voice evacuation system (ECS). The system shall be a U.L listed, modular, low voltage system with multiple communications features; capable of supporting intelligent addressable devices, analog detection devices and communicating over high-speed data networks.
  - 1. The fire alarm system shall be designed, installed, programmed, tested and delivered in full operating condition.
  - 2. The system shall include all required hardware, raceways, wiring and software to accomplish the requirements of these specification.
  - 3. All equipment shall be new and the latest state of the art products provided by the manufacturer.
- C. Manufacturer:
  - 1. NOTIFIER® by Honeywell (see Section 2.1), no exceptions, for the following:
    - a. Fire Alarm Control Panel (FACP);
    - b. Fire Alarm Remote Annunciator Panels (FAAP);
    - c. Remote Power Supplies;
    - d. Smoke, Heat & Duct Detectors;
    - e. Relay, Control & Monitor Modules;
    - f. Manual Pull Stations;
    - g. Amplifiers.
  - 2. System Sensor®, no exceptions, for the following:
    - a. Speakers;
    - b. Strobes.

1.2 MATERIALS AND SERVICES

- A. The system shall include, but not be limited to the following elements:

1. All fire detection, voice/audio and visual evacuation alarm control modules, supervised power amplifiers with the required back up modules.
2. Circuit interface panels including all modules.
3. Power supplies, batteries and battery chargers.
4. Pre-amplifiers, amplifiers, and tone generators.
5. Equipment enclosures.
6. Intelligent, addressable manual pull stations, heat detectors, alarm monitoring modules, supervised control modules, and analog smoke detectors.
7. Voice, Audible and Visual evacuation signaling devices.
8. Color graphic displays and historical archiving.
9. Software and programming as required to provide a complete functioning system.
12. Wiring and raceway.
13. Installation, testing, certification and training.
14. Monitor and Control modules for interface with electrical, mechanical, fire sprinkler, kitchen fire suppression, CO monitors, elevator and security equipment systems (see plans for coordination of those systems with the fire alarm system design and equipment).
15. Connection to MDF room for remote monitoring by the UNT Fire Systems Group.
16. Remote annunciator panels at each building entrance door or as required by the UNTS Fire Marshal or UNTS AHJ.

### 1.3 REFERENCE STANDARDS

- A. The publications listed below form a part of this publication to the extent referenced. The publications are referenced in the text by the basic designation only. The latest version of each listed publication shall be used as a guide unless the authority having jurisdiction has adopted an earlier version.
  1. Texas Department of Insurance (TDI) State Fire Marshal's Office;
  2. National Fire Protection Association (NFPA):
    - a. NFPA 72 Standard for the Installation, Maintenance and use of Protective Signaling Systems;
    - b. NFPA 13 Standard for the Installation of Sprinkler Systems;
    - c. NFPA 70 National Electrical Code;
    - d. NFPA 90A Standard for the Installation of Air Conditioning and Ventilating Systems'

- e. NFPA 101 - Life Safety Code.
- 3. Texas Insurance Code Chapter 6002, Fire Detection and Alarm Device Installation;
- 4. 28 TAC §§ 34.600 The Fire Alarm Rules;
- 5. Underwriter's Laboratories, Inc. (UL);
- 6. Texas Accessibility Standards (TAS);
- 7. UNTS Specifications.

#### 1.4 QUALIFICATIONS OF THE INSTALLER

- A. The installing contractor shall specialize in the design and installation of fire alarm systems. The firm shall have a minimum of three years of verifiable commercial fire alarm system design and installation experience.
- B. State License. The firm shall be registered as a fire alarm contractor (Alarm Certificate of Registration (ACR) with the Texas State Board of Insurance Underwriters (TDI) and have in its employ, a Fire Alarm Planning Superintendent (APS), licensed by the Texas State Board of Insurance Underwriters (TDI); and Fire Alarm Technician(s) (FAL), licensed by the Texas State Board of Insurance Underwriters (TDI). The firm shall also be an authorized NOTIFIER authorized distributor.
- E. Installer Qualifications: Installer(s) must be Fire Alarm Technician (FAL), licensed by the Texas State Board of Insurance Underwriters (TDI), and be a certified NOTIFIER equipment technician.
- F. Insurance: The installing firm shall carry liability insurance in the amount and manner specified by the Texas State Board of Insurance Underwriters (TDI) to install fire alarm systems.
- G. All fire alarm panel, ONYXWorks® and their associated programming shall be done by a NOTIFIER® certified technician.
- H. Before commencing work, the installing contractor shall submit data showing that the contractor has successfully installed fire alarm systems of the same type and design as specified, or that they have a firm contractual agreement with a state licensing subcontractor having the above required manufacturer's training and experience. The contractor shall include the names and locations of at least two installations where the contractor, or the subcontractor above, has installed such systems. Specify the type and design for each system and furnish documentation that the systems have performed satisfactorily for the preceding 18 months.

#### 1.5 SUBMITTALS

- A. The contracting firm shall submit copies of its Texas Department of Insurance (TDI) Fire Alarm Contractor Registration (ACR), Fire Alarm Planning Superintendent License (APS) and the required TDI's Liability Insurance Certificate, signed by a Texas Insurance Agent.
- B. The contractor shall include the following information in the equipment submittal:
  - 1. Power calculations.



- a. Battery capacity calculations. Batteries shall be sized at least 150% of the calculated requirement.
  - b. Supervisory power requirements for all equipment.
  - c. Alarm power requirements for all equipment.
  - d. Power supply rating justification showing power requirements for each of the system power supplies. Power supplies shall be sized to furnish the total connected load in a worst-case condition.
  - e. Justification showing power requirements of the system amplifiers.
  - f. Voltage drop calculations for wiring runs demonstrating worst case condition.
2. Complete manufacturer's catalog data including supervisory power usage, alarm power usage, physical dimensions, finish and mounting requirements.
  3. Data describing more than one type of item shall be clearly marked to indicate the type the contractor intends to provide for options not crossed out in submittal material will be furnished for the project. All submittal material shall be complete. Partial submittals will not be evaluated and will be rejected without comment.
  4. Submit panel configuration and interconnection of modules and all other data as required to make an informed judgment regarding product coverage and performance. At a minimum, data shall be submitted on the following:
    - a. Master system CPU including all fire detection, voice/audio and visual evacuation alarm control modules, and supervised power amplifiers with the required back up modules.
    - b. Circuit interface panels including all modules.
    - c. Power supplies, batteries and battery chargers.
    - d. Pre-amplifiers, amplifiers, tone generators, master microphone and master telephone.
    - e. Equipment enclosures, including dimensions and weights of completed units.
    - f. Intelligent addressable manual pull stations, heat detectors, analog smoke detectors, alarm monitoring modules, and supervised control modules.
    - g. Annunciator panels.
    - h. Audible and visual evacuation signals and devices.
    - i. Software and firmware as required to provide a complete functioning system.
    - j. Circuiting, including conduit and wire sizes.
    - k. All interface and connection with ONYXWorks remote terminals – UNTPD and Fire Systems Offices.

- C. Complete drawings covering the following shall be submitted by the contractor for the proposed system:
1. Floor plans showing all communicating, initiating, supervisory, indicating appliances, and output control devices; including circuit interface panels, message digitizers, amplifiers, annunciators, video display terminals, color graphic displays, transponders and the main CPU locations. Raceways shall be shown, marked for size, conductor count with type and size, showing the percentage of allowable National Electric Code fill used. Drawings shall indicate ambient sound levels used by the system installer for sound level calculations.
    - a. The FACP, FAAP, remote power supplies, electronic control boards and batteries shall be installed in rooms or locations where relative humidity is maintained at less than 90% and temperature is maintained between 60° - 80° F.
  2. Wiring diagrams showing points of connection and terminals used for all electrical connections to the system devices and panels.
- D. A complete proposed system database including a description of all logic strings, control by event programming and point identification labels on a CD ROM and in a formatted printed form, as required for offsite editing, uploading and downloading shall be submitted for evaluation by the owner. A programming manual shall accompany the submitted program and shall be adequate to allow understanding, operation and editing by the system owner.
- E. For use in system test, a complete operation and maintenance manual with two sets of proposed installation drawings shall be submitted.
1. The following information shall be inscribed on the cover:
    - a. "OPERATION AND MAINTENANCE MANUAL"
    - b. Building name and address.
    - c. The name of the fire alarm firm/contractor, Alarm Planning Superintendent and alarm system manufacturer.
  2. The manual shall be legible and easily read with a full-size copy of record drawings folded and contained in pockets. Included in the manual shall installed equipment details, circuit drawings, wiring and control diagrams and data to explain detailed operation and control of each item of equipment and a control sequence describing start up instructions. Included shall be installation instructions, maintenance instructions, safety precautions, test procedures, performance data, and software documentation.
- F. Upon completion of the installation, record drawings shall be submitted on each system before final acceptance of the work. In addition to the records drawing master, the contractor shall furnish to the Owner two sets of record drawings including system diagrams for each system. The record drawings masters shall be high quality for legibility and reproduction and on high density CD ROM in an AutoCAD DXF format.

## 1.7 SYSTEM FUNCTION

- A. The system shall be a complete, electrically supervised multiplex style fire detection and voice evacuation system with intelligent analog alarm initiation, to be device addressable and annunciated as described and shown on the drawings.
1. Devices attached to the signaling circuit shall be individually identifiable at the control panel for alarm and trouble indication. Smoke detectors shall be interrogated for sensitivity settings from the control panel, logged for sensitivity changes indicating the requirement for cleaning, and tested by a single technician using the panel field test routine.
  2. Sensitivity settings of individual detectors shall be automatically or manually adjustable from the control panel to reduce the incidence of false alarms caused by environmental conditions.
  3. The system shall support intelligent analog smoke detection, manual station, water flow, supervisory, security, and status monitoring devices. Fire alarm, supervisory, trouble, security and status shall each be treated as a separate level of alarm, each with its own level of priority. The system shall also support amplifiers, voice/visual circuits, telephone system and smoke control fans and dampers.
  4. The panel shall be UL listed as a test instrument for the measurement and logging of the sensitivity of connected intelligent analog ionization and photoelectric smoke detectors connected to the control panel or any remote circuit interface panel to comply with the bi-annual sensitivity logging requirements of NFPA 72.
    - a. The measurements shall be discrete voltage readings, accurate to .01 VDC. The readings shall be dynamic, providing a constant display of voltage shifts of the device being tested when in the sensitivity voltage list mode.
    - b. The control panel shall provide a display of these sensitivity measurements. An output shall be provided, together with a Windows XP based utility program to allow the data acquired in the sensitivity testing mode to be downloaded into a laptop computer and utilized in a data base program to formulate a complete system history or be printed as a permanent record of the required sensitivity testing.
    - c. Light refraction style smoke detector shall be capable of self-adjustment to compensate for the accumulation of contaminants that would change the detector sensitivity in either a more or less sensitive direction. This adjustment shall keep the relationship between the sensing chamber voltage and the programmed alarm threshold voltage constant to prevent false indications or failure to alarm in the presence of smoke. Data contained in a memory bank on each detector so programmed, shall maintain an average of the chamber voltage in determining the threshold setting for the device. The threshold setting installed in memory within each device shall maintain programmed operation in all cases, including default and default alarm modes. All devices programmed with this feature shall be automatically tested by the control panel once every twenty-four hours to assure their ability to detect and report an alarm condition. This test shall be done as a background

routine and shall remain transparent to the user. In the event of a test failure, the control panel shall report a trouble message for the failed device.

5. The system shall annunciate a pre-clean trouble condition when any smoke detector reaches 80% of the allowable threshold movement within the prescribed UL window due to gradual contamination, signaling the need for service, and eliminating unwanted alarms. Upon reaching 100% of the allowable movement, a second "Detector Dirty" message with a trouble condition shall be displayed.
  - a. The trouble report shall annunciate the specific location of the smoke detector requiring service. All analog smoke detectors installed in the system shall include this feature.
  - b. Upon completion of the cleaning of the device, the system shall reestablish the average chamber voltage file, determining if the detector sensitivity falls within the required window, and display a "Detector Cleaned" message. The detector cleaning shall be logged to the system history file.
6. Any intelligent analog smoke detector shall include a selectable alarm verification capability. This feature shall provide automatic verification of smoke detector alarms as described by NFPA 72. The system shall have the capability of logging to historical memory, the time and date of all unverified alarm events in order to track activity and generate reports indicating maintenance requirements prior to failures within the system.
7. All external circuits shall be listed as power limited circuits per the National Electric Code. Power limitation shall be provided using on board, self-restoring solid state thermal devices. Units using fuses or manually restorable circuit breakers for this purpose or requiring board replacement or exchange will not be acceptable.
8. The system shall recognize initiating of an alarm and indicate the alarm condition in a degraded mode of operation, in the event of processor failure or the loss of system communications to the circuit interface panels.
  - a. Each circuit interface panel shall be capable of operation in its own degrade mode. In this mode, the system shall receive an alarm from any intelligent analog or conventional initiating device. It shall activate local indicating appliances and remote or auxiliary connect circuits.
  - b. The system shall indicate a trouble condition during degrade mode operation and shall give a visual indication of an alarm condition.
  - c. Detector operation in the degrade mode shall continue at the alarm threshold previously programmed. Systems returning detectors to a common default value in degrade mode shall not be acceptable.
8. The system shall provide a default operation program to allow reporting of alarms from installed devices before loading of custom system software.
9. The system shall report alarms from installed devices but not yet added to the system custom program. Alarm reports from these devices shall activate indicating appliance circuits.

10. The system shall perform time-based control functions including automatic changes of specified smoke detector sensitivity settings. Time based functions shall be controlled by specifying time periods or actual dates. It also shall provide the ability to control these functions on an exception basis using a holiday schedule.
11. The system shall provide a one-person field test initiated from the control panel of either the complete system or a specified area supported from either the master control panel or any remote circuit interface panel, maintaining full function of areas not under test.
  - a. Field test shall be usable in a silent or audible mode. When in the audible mode, the signals shall audibly annunciate alarms, troubles and device types, each in a way identifiable by the testing technician.
  - b. All field test activity shall be logged to the system historical memory. It shall be possible to download historic memory to a data base program prior to, and subsequent to the walk test in order to establish a continuous system history.
12. The system shall be provided with eight levels of password protection with up to forty passwords. In addition, the system shall provide for up to sixty-four password protected sublevels protecting functions or groups of functions under operator control. Passwords and functions shall be field programmable.
13. The system shall be programmed in the field via a laptop computer. All programmed information shall be stored in nonvolatile memory after loading into the control panel. No special programming terminal or prom burning shall be required and the system shall continue in service during reprogramming. Systems requiring on line terminal programming or not capable of mass reading of panel software for offsite documentation or editing will not be considered acceptable.
  - a. During program reading or loading, the system shall retain the capability for alarm reporting.
  - b. The system shall read to a PC for program editing. System program shall be stored on a CD ROM and all programming shall be multilevel password protected.
  - c. A U.L. recognized programming utility shall be furnished to compare all altered functions, and input or output addresses, listing all related functions, inputs and output addresses that are effected by the program changes. These items shall constitute a minimum for required certification re-testing of the system in addition to the system device percentage mandated by the codes. Systems not providing this utility shall not be acceptable due to the expense related to complete re- testing for re-certification after program changes. The system shall consist of a central or distributed multiplex architecture using a centrally located control unit with interconnection to remote circuit interface panels containing any combination of pluggable intelligent analog signaling circuits and plug in relays.
  - d. The remote circuit interface panels shall as a minimum, provide a power supply, microprocessor-controlled bus structure, battery and automatic

charger, and communication link to the main CPU through a high-speed network.

- 1) The high-speed communications network shall support the use of fiber optics transmission techniques for the elimination of all electrostatic and electromagnetic induced electrical interference configured as a star loop.
- G. The network communications format shall include error checking of the installation location of each module address to verify the agreement between programmed software and installed hardware as a protection against card installation in incorrect plug-in slots. Module printed circuit cards shall be configured within each cabinet to physically prevent the installation of a card in an incorrect slot in that cabinet.
1. The system shall provide status indicators and control switches for all of the following functions:
    - a. Audible and visual evacuation alarm circuit zone control.
    - b. Status indicators for sprinkling system water flow and valve supervisory devices.

## 1.8 SYSTEM ZONING

- A. Each intelligent addressable device on the system shall be displayed at the fire alarm control panel by a unique alpha numeric label and room number identifying its location.

## 1.9 SYSTEM OPERATION

- A. Activation of any fire alarm initiating device shall cause the following actions and indications, unless otherwise noted below:
1. General alarm sounds on all floors;
    - a. Visual notification devices activated;
    - b. Voice annunciation message is activated;
  2. FACP sends notification to the central monitoring station (UNTPD);
  3. Fire doors and smoke doors close on all floors;
  4. All central air handling units shut down;
  5. Central exhaust fans shall continue operation;
  6. All smoke dampers close;
  7. All exit doors unlock;
  8. Stair pressurization or exhaust fans (if present) operate.
  9. Elevator recall shall be by initiating devices located in either the elevator lobbies, elevator shaft or elevator equipment room.
    - a. Activation of any alarm verified smoke detector in a single elevator lobby or an elevator equipment room shall cause the recall of that elevator or bank of elevators to the terminal floor and the lockout of controls. In the event of recall initiation by a detector in the terminal floor lobby, the recall shall be to the

- alternate floor. Activation of any heat detector in the elevator machine room/pit shall cause the fireman's hat in the elevator car(s) to flash.
10. Smoke detectors inside residence hall dorm rooms shall be programmed to cause the following actions and indications:
    - a. If one dorm room smoke detector activates:
      - 1) SD shall sound alarm in immediate room;
      - 2) Room SD activation sent to FACP;
      - 3) FACP sends notification to central monitoring station (UNTPD);
      - 4) FACP sounds SD activation signal at supervised panel and FAAP locations.
    - b. If two or more dorm rooms' smoke detectors activate:
      - 1) SDs sound alarm in all dorm rooms;
      - 2) SDs send activation notification to FACP;
      - 3) FACP sounds General Alarm on all floors and dorm rooms;
      - 4) FACP sends notification to the central monitoring station (UNTPD);
      - 5) Voice annunciation message is activated;
      - 6) FACP sends activation information to FAAP locations.
  11. Smoke Detectors inside Hall Directors', Faculty and Staff apartments shall be programmed to cause the following actions and indications:
    - a. If one or two smoke detectors in the same apartment activate:
      - 1) All SDs in the same apartment shall alarm;
      - 2) Apartment SD activation notification sent to FACP;
      - 3) FACP sends notification to central monitoring station (UNTPD);
      - 4) FACP sounds SD activation signal at supervised panel and FAAP locations.
    - b. If more than two smoke detectors in the same apartment activate:
      - 1) FACP sounds General Alarm on all floors and dorm rooms;
      - 2) FACP sends notification to the central monitoring station (UNTPD);
      - 3) Voice annunciation message is activated;
      - 4) FACP sends activation information to FAAP locations.
  12. Where building is a High-Rise Building or Patient Care Facility, coordinate fire alarm programming with UNTS Fire Marshal.
  13. Activation of any single air duct detector shall shut down that air handler unit and send a supervisory signal to the FACP & FAAP.
  14. Activation of any supervisory circuit; i.e., supervised valve closure, air pressure abnormal, low temperature, fire pump trouble, duct detector SD, etc., shall cause the following actions and indications:
    - a. Display the origin of the supervisory condition report at the FACP and FAAP alpha numeric LCD display.
    - b. Activate supervisory audible and visual signals at the FACP and FAAP. Audible signals shall be silenced from the fire alarm control panel by an alarm acknowledge switch. The supervisory indication shall be transferred to a visual indicator on the control panel and the supervisory signals shall resound for a subsequent supervisory condition, reported by a different device.
    - c. FACP shall send a supervisory notification to the central monitoring station (UNTPD).

- d. Record within the system history the occurrence of the event, the time of occurrence and the device initiating the event.
- B. The FACP shall:
1. Display a custom message, describing the device originating the alarm condition at the main fire alarm control panel and remote annunciators;
  2. Report to the UNT Police Department via dialer. Two telephone lines shall be provided. Coordinate requirements with UNT and telecom plans.
  3. Sound an alarm tone for a maximum of five seconds followed by an automatic digital voice message over all alarm circuits. At the end of the voice message, the alarm tone shall resume. The audio alarm signals shall sound alternately until the signal silence switch is operated.
    - a. All audio operations (speaker circuit selection and alarm tone/voice messages and timing variations) shall be activated by the system software, so that future changes can be implemented without rewiring or hardware additions. Audible signals shall be silenceable from the fire alarm control panel by an alarm silence switch. The alarm indication shall be transferred to a visual indicator on the control panel and the alarm signals shall resound for a subsequent alarm condition, reported by a different device. Visual signals shall be programmable to flash until system reset or alarm silencing, as required.
    - b. A signal dedicated to sprinkler system water flow alarm shall not be silenced while the sprinkler system is flowing at a rate of flow greater than or equal to a single head.
    - c. Status lights next to speaker selection switches on the control panel shall indicate which message each speaker circuit is distributing.
    - d. Provisions for total building paging shall be accomplished by an "All Page Switch".
  4. Record within the non-volatile system historical memory, the occurrence of the event, the time and date of occurrence and the device initiating the event. In addition, all operator actions shall be logged to system history with time and date.
- C. Receipt of a trouble report; i.e., primary power loss, open or grounded initiating or signaling circuit wiring, open, grounded or shorted indication system wiring, device communication failure, battery disconnect at the fire alarm control panel shall cause the following actions and alarms.
1. Display at the main fire alarm panel and remote annunciator alphanumeric LCD display, the origin of the trouble condition report.
  2. Activate trouble audible and visual signals at the FACP and FAAP.
    - a. Audible signals shall be silenced from the fire alarm control panel and remote annunciator by a trouble acknowledge switch. The trouble indication shall be transferred to a visual indicator on the control panel and the trouble signals



shall resound for a subsequent trouble condition reported by a different device.

- b. Trouble conditions which have been restored to normal shall be automatically removed from the trouble display queue and not require operator intervention. This feature shall be software selectable and shall not preclude the logging of trouble events to the historical file.
  - c. FACP shall send a supervisory notification to the central monitoring station (UNTPD).
3. Record within system history, the occurrence of the event, the time of occurrence and the device initiating the event.

#### 1.10 PROGRAMMING

- A. All fire alarm panel, ONYXWorks and associated programming shall be done by a NOTIFIER certified technician.
  1. The fire alarm contractor shall include creating the respective building's monitoring and control program in ONYXWorks.

#### 1.11 SECURITY SYSTEM INTERFACE

- A. Automatic Unlock of Electric Locking Mechanisms.
  1. Power fail open security locking mechanisms shall automatically unlock upon a fire alarm condition.
  2. To provide for automatic unlocking, the fire alarm contractor shall provide a normally closed auxiliary dry output contact from the fire alarm system. Upon a fire alarm condition, the contact shall open and the security system shall unlock the electric locking mechanisms. The contact shall remain open until the fire alarm system is manually reset.
- B. Manual Release of Electric Locking Mechanisms.
  1. Security electric locking mechanisms as indicated on the security plans shall be manually unlocked from a switch at the main fire alarm control panel.
  2. To provide for manual unlocking, the fire alarm contractor shall provide a DPST switch in the main fire alarm control panel. Upon activation of the switch, a normally closed dry contact shall open and the security system shall unlock the electric locking mechanisms. The contact shall remain open until the switch is returned to the locked position.
  3. The fire alarm contractor shall provide an additional normally closed dry contact from the switch for security system monitoring of the position status of the switch.
- C. Automatic Bypass of Card Reader Control of Elevators.

1. The card reader control of elevators shall be automatically bypassed by the security system upon a fire alarm condition.
  2. To provide for automatic bypass the fire alarm contractor shall provide a normally closed dry output contact from the fire alarm system. Upon a fire alarm condition, the contact shall open and the security system shall bypass the card reader control of elevators. The contact shall remain open until the fire alarm system is manually reset.
- D. Submittal.
1. Submit product specifications, fabrication shop drawing, and wiring diagrams for the following:
    - a. Dry Contacts
    - b. Interface terminal box
    - c. DPST Manual Switch

## **PART 2 - PRODUCTS**

### **2.1 FIRE ALARM CONTROL PANEL**

- A. FACP shall be campus standard NOTIFIER® NFS2-3030, no exception. In addition to its standard features, the FACP shall include:
- a. CPU2-3030D Primary Display and power supply;
  - b. ONYXWorks® high speed network;
  - c. NOTIFIER® embedded gateway (NFN-GW-EM-3);
  - d. NOTIFIER® high speed network communications modules (HS-NCM-W);
  - e. Digital Voice Communication (DVC-EM);
  - f. DAA Series Digital Audio amplifiers;
  - g. UDACT-2 Digital Communicator
  - h. Liquid Crystal Display Annunciators (LCD-160)
- B. FAAP shall be NOTIFIER® LCD-160.
- C. The control panel shall be modular in construction and shall include, but not be limited to; the hardware, software and firmware required to perform the following major system functions:
1. Surface mounted steel cabinet with indicator viewing window, hinged door and cylinder lock, dead front construction with outer door open, and factory finished in baked black enamel.

2. System power supplies, including necessary transformers, rectifiers, regulators, filters and surge protection required for system operation, with the capacity to power the system in a worst-case condition with all devices in alarm and all local indicating appliances active without exceeding the listed ratings. The system devices shall display normal and alarm conditions consistently whether operating from normal power or reserve (standby) power.
3. The integrated voice system shall operate up to three voice channels simultaneously; Evacuation, Alert and Auxiliary. Systems using a dedicated paging channel shall not be considered equal.
4. The integrated voice system shall utilize local and distributed amplification as required for optimum system performance, configuration and voice intelligibility.
5. The voice system amplifiers shall be capable of operating 25vrms and/or 70vrms speakers as required to optimize system performance. The amplifiers shall provide a minimum of 100 watts of power each. Amplifiers shall automatically transfer to battery when power fails or is disconnected. The amplifier shall have LED's indicating "AC power fail" and "Battery trouble". Sufficient amplifier power shall be provided to furnish a minimum average of 2 watts of power to all connected speakers on each channel, and in all spaces, provide the code mandated 15DbA above the prevailing equivalent sound level or 5DbA above the maximum sound level whichever is louder. Sound levels as specified by the NFPA 72 shall be furnished throughout. Amplifiers shall be protected by a backup amplifier capable of assuming the load of a failed amplifier automatically.
6. An audio control module shall be supplied as the master control module for all voice related functions. The audio control module shall communicate with the fire alarm master via high-speed network communications lines.
  - a. A supervised tone generator capable of providing a variety of tones for use in the system shall be included within the capabilities of this module. Software configuration shall determine which tone the system uses. Minimum available signal configurations shall be:
    - 1) Slow Whoop.
    - 2) 900Hz Steady, pulsed at 120 ppm, pulsed at 30 ppm, coded, temporal code 3, California code, zone code, or 4-4-4.
    - 3) Chime, pulsed at 120 ppm, pulsed at 30 ppm, coded, temporal code 3, California code, zone code, or 4-4-4.
    - 4) Horn Steady, pulsed at 120 ppm, pulsed at 30 ppm, coded, temporal code 3, California code, zone code, or 4-4-4.
    - 5) 2000Hz Steady, pulsed at 120 ppm, pulsed at 30 ppm, coded, temporal code 3, California code, zone code, or 4-4-4.
    - 6) Hi/Lo
    - 7) Wail.

- b. A backup tone card shall be furnished for the audio control module.
7. The master microphone module shall be permanently mounted behind the locked access door, visible through the viewing window and provide firefighters with the means of issuing voice message instructions to specific audio zones, groups of zones or all zones. The microphone and the press-to-talk switch shall be supervised. This module shall contain a local speaker with volume control to monitor selected audio channels.
8. The amplifier supervision modules shall supervise the output of all amplifiers, providing automatic switching of backup amplifier output when required.
9. Manual control and annunciator modules shall be provided on the face of the control panel in quantities required by the system. Module circuit labels shall be color coded to indicate speaker control, water flow indication and valve supervision.
  - a. Furnish for the indication and control of all system speaker zones, modules comprised of eight software programmed switches, each capable of displaying status of the controlled zone via LED's capable of displaying three different colors in both the steady and flashing state to denote the active status circuit and indicate trouble. All switch activation and LED status indications shall be software mapped to any system functions desired. Systems requiring the use of multiple switches to activate groups of zones or functions shall not be acceptable.
    - 1) Speakers shall be located where indicated on plans.
    - 2) Strobe visual signals shall operate in conjunction with the automatic activation of the speaker zones. Visual signals shall be programmable to remain activated until system reset or system acknowledgment, as required.
  - b. Furnish for the display of fire sprinkler system status, annunciator modules comprised of eight software programmed switches, each capable of displaying status of the controlled zone via LED's capable of displaying three different colors in both the steady and flashing state to denote the status and indicate trouble, shall be provided in quantities as required to indicate real time status of each system water flow switch and valve supervisory switch.
10. Provide as required, speaker/strobe zone modules providing 8 zones Style Y for either supervised speaker circuits or 24 VDC strobe light or combination of the two indicating type signals. Modules shall incorporate solid state self-restoring current limiting. Equipment requiring fuse replacement, manual resetting, or card replacement will not be considered acceptable.
11. The enclosure for the system shall provide complete dead front construction when the outer cabinet door is opened, with no wiring, terminals, batteries or electronic components visible. Human interface modules shall be on a frame hinge mounted to provide easy access to wiring and system plug in cards. Enclosure door shall be pin hinged and removable, for easy system operation by firefighters and technicians in testing and maintenance modes.

12. The system shall include a real time link to the system database, historical event log, logic, and operating system. The system shall require no manual input to initialize in the event of a complete power down condition. It shall return to an on-line state as an operating system performing all programmed functions upon power restoration. Systems requiring battery backed-up memory devices shall not be acceptable.
  - a. The system shall be capable of programming to allow troubles occurring and restored in the system to be automatically removed from the display queue, eliminating the necessity for individual acknowledging of these events. This feature shall not affect the historical logging of events as programmed.
  - b. As a minimum, an LED display for "ALARM", "AUDIBLES SILENCED", "SUPERVISORY", "TROUBLE", "SECURITY", "POWER ON" and "PARTIAL SYSTEM DISABLED".
  - c. Touch activated membrane switches for "ALARM ACKNOWLEDGE", "AUDIBLE SILENCE", "SUPERVISORY ACKNOWLEDGE", "TROUBLE ACKNOWLEDGE", "SECURITY ACKNOWLEDGE", "RESET", "DISPLAY HOLD" and "DISPLAY NEXT".
  - d. All membrane switches shall be tactile with audible feedback when pressed.
  - e. Touch activated membrane switches, programmable to perform a minimum of twelve custom designed and programmed functions such as drill, disable, bypass automatic control commands or other special functions as required by the system user. The membrane switches shall also be used for the entry of individual pass codes, allowing for an individual code for each operator allowed to perform security bypass functions.
  - f. Ten-digit keypad for pass code entry to perform programming and maintenance functions.
13. The system shall support a minimum of three supervised remote alpha- numeric annunciators as full function remote control points. Software defined logic module as required for each alarm initiation point, capable of controlling any combination of the system output functions using as logic factors; counting, verification, time, day, holiday, type of device, "and", "or", "not", "timer", "all", "any", flip-flop, D latch, and up to 32 levels of programming shall be possible.
14. Selective historical log events of all types shall be stored in flash memory and displayed, printed or downloaded by classification for selective event reports.
  - a. The system shall allow selection of events to be logged, including inputs, as: alarms, troubles, supervisories, securities, status changes, walk tests and device verification, outputs as: audible control and output activation, actions as; reset, set sensitivity, arm/disarm, override, password, set time and acknowledge.

- b. Data format for downloading shall be compatible with the data base handling program, allowing custom report generation to track alarms, troubles and maintenance.
  - c. Audible and visual indications shall be generated when memory is 80% and 90% full to allow downloading of data. The system shall be programmable circular logging, assuring that at least the last 400 events will always be stored in non-volatile memory.
  - d. Downloading historical events shall set a system flag at the last event downloaded to allow future retrieval to start at that point, assuring a continuous history log.
15. Environment compensating, software driven logic for adjusting the alarm threshold windows on detectors to compensate for accumulating contamination and keep detector response sensitivity constant. The software shall compensate for either over-sensitized or de-sensitized units, raising a system flag when a detector approaches the allowable limits of adjustment, indicating a requirement for cleaning.
- a. Environment compensation values shall be stored in non-volatile memory allowing activation of all tracking functions within 90 seconds of system initiation from a "cold boot". During the boot sequence, alarms from detectors programmed with the feature shall be suppressed. When the full data history is active all devices shall be checked and any active alarms displayed.
  - b. The control panel shall place each detector in the system in an alarm condition, transparent to the system user, every twenty-four hours as a dynamic check of the accuracy of the alarm threshold setting. Upon reception of the alarm report, the system detector shall be restored to its pretest state.
  - c. The system shall be capable of monitoring the state of detectors and displaying a message when a detector is approaching the limits of adjustment as a result of contaminates. A second message shall be displayed when the detector reaches the limits of adjustment due to these contaminates.
  - d. The system shall recognize that a detector has been cleaned, initiating a series of tests to determine if the cleaning was successful and display a detector cleaned message, readjusting that detector's normal sensitivity setting reference based on a new cumulative average.

## 2.2 FIRE ALARM SYSTEM AND REMOTE POWER SUPPLIES

- A. Primary power for the FACP and individual remote power supplies, and the secondary power battery chargers shall each be obtained from the nearest 120 V emergency panel. FACP power supply shall be connected to a U.L. listed surge protector. See plans for the exact location of the 120 V power panel.
- B. Secondary power supply. Provide sealed gelled electrolyte batteries as the secondary power supply for the fire alarm control panel and each system circuit interface panel. The battery supply shall be calculated to operate its load in a supervisory mode for twenty-four

hours with no primary power applied and, after that time, operate its alarm mode for two hours.

1. Batteries shall be sized 150% of the calculated size to compensate for deterioration and aging during the battery life cycle. Battery calculations shall be submitted to justify the battery size. Batteries shall be housed in the control cabinet or a separate cabinet with adequate cell separation to prevent accidental discharge.

### 2.3 SPARE BOX

- A. Provide a separate box located adjacent to the main fire alarm panel. The box shall be sufficiently sized (16" X 16" X 6" minimum) to hold all spare detectors and paperwork. This box shall match the main fire alarm panel in appearance and be keyed the same.

### 2.4 REMOTE CIRCUIT INTERFACE PANELS

- A. Remote circuit interface panels shall consist of an enclosure, a remote power supply, digital communications circuitry, mother boards, batteries and hardware, modules and circuitry described for inclusion in the fire alarm control panel as required to function as specified.
  1. Circuit interface panels, when required, include conventional zone module, analog loop drivers, indicating appliance circuits, output circuitry to perform actions, speaker supervisory and distribution circuits. All fire detection, alarm and indicating devices supported by the circuit interface panel shall function as a self-standing system in the failsafe mode upon loss of the central fire alarm control panel processing, communications or the communications wiring between them.
  2. Smoke detectors shall alarm at their programmed sensitivity settings and shall not revert to a common default setting when their operating system segment is in the default mode.
  3. Circuit interface panels shall support remote system displays, annunciators and printers. Test procedures shall be capable of initiation at the main fire control panel, any remote LCD annunciator or any remote interface panel equipped with a keypad.

### 2.5 DETECTOR BASES

- A. Detector Bases – Detector bases for public areas shall be low profile, surface or flush mounted on a standard 4" square by 2-1/8" deep box. Bases shall be able to accept photoelectric, ionization or heat detectors.
- B. Detector Bases for sleeping/dwelling units shall be sounder bases for all system smoke detectors located in sleeping/dwelling units. Sounders shall produce a low frequency 520 Hertz  $\pm$  10% frequency alarm signal that complies with NFPA 72 Section 18.4.5.

### 2.6 SMOKE DETECTORS-PHOTOELECTRIC

- A. Furnish and install intelligent analog photoelectric smoke detectors in accordance with NFPA 72, in all sleeping/dwelling units and public areas and where indicated on the drawings.
    - 1. Manufacturers:
      - a. Detector shall be campus standard System Sensor, no exception.
- 2.7 DUCT DETECTORS-PHOTOELECTRIC
- A. Furnish and install where indicated on the drawings, intelligent analog smoke detectors
    - 1. Manufacturers:
      - a. Detector shall be campus standard System Sensor, no exception.
        - i. if mounted where the detector is not readily accessible or within normal view, a remote visual indicator and control for testing and re-setting unit shall be installed in close proximity in a readily accessible, viewable location.
- 2.8 HEAT DETECTORS, INTELLIGENT RATE COMPENSATED
- A. Furnish and install where indicated on the drawings, intelligent analog smoke detectors
    - 1. Manufacturer:
      - a. Detectors shall be campus standard System Sensor, no exception.
- 2.9 MANUAL STATIONS, INTELLIGENT
- A. Provide double action, intelligent, manual fire alarm “Pull Stations” where shown on the plans. Pull stations shall be:
    - 1. Manufacturer:
      - a. Pull Stations shall be campus standard NOTIFIER, no exception, and shall be:
        - i. red in color;
        - ii. provide a clear indication when activated;
        - iii. labeled “FIRE”;
        - iv. equipped with terminal strip and pressure style screw terminals for the connection of field wiring;
        - v. flush mounted.
- 2.10 MAGNETIC HOLD OPEN DEVICE
- A. Provide 24VDC magnetic hold open devices where indicated in architectural door hardware specification. Devices shall release upon activation of a fire alarm.
- 2.11 INTELLIGENT SYSTEM INTERFACE MODULE
- A. Furnish and install, for the monitoring of contact type initiation devices and for the control of electrical devices where required, intelligent analog signaling circuit interface module.



- B. The module shall be suitable for two wire, two-way communications on the intelligent analog signaling circuit. The module shall display a flashing LED for each circuit, in the normal power or standby power condition. The module shall display a steady LED when in the alarm state or during control circuit activation.
- C. Modules shall incorporate triple technology microprocessor chips including analog, digital and EEROM technologies on the single device.

#### 2.12 FIRE SPRINKLER SYSTEM DETECTION AND SUPERVISION

- A. Furnish fire alarm monitoring modules for interconnection of the following fire sprinkler system functions (see fire sprinkler plans for type of equipment and location):
  - 1. Water flow switches and their associated audio/visual device at the FDC, control valve tamper switches, fire pump controller, emergency generator monitoring, dry system air compressor power or air pressure monitoring, fire sprinkler pipe heat trace and other required fire sprinkler equipment and pipe heating equipment power.
  - 2. Outside screw and yoke valve supervisory switches in sizes as required for monitoring valves as indicated on the drawings. The single pole double throw supervisory switch shall activate an off normal report within one half turn of the valve.

#### 2.13 INTELLIGENT SUPERVISED CONTROL MODULE

- A. Furnish and install for the control of supervised relays, contactors, audible signal circuits, visual signal circuits, distributed speaker circuits and two-way fire fighters' communication circuits, intelligent supervisory and control modules including features as follows:
  - 1. The modules shall be suitable for two wire operation and communications on intelligent analog alarm detection loops. Address assignments shall be accomplished electronically. Devices requiring dip switches, rotary switches, staples and/or jumpers are not acceptable.
  - 2. The module shall display a flashing LED in the normal power or standby power condition, and a steady LED when in the activated state.
  - 3. The module shall be suitable for semi-flush or surface mounting in a 2" deep, 4" square or double gang electrical outlet box having a depth of 3 1/2".
- B. Modules shall be available to supervise reverse polarity supervised indicating circuits utilizing 24VDC, two-way supervised fireman's communication circuits or audio circuits utilizing 25VRMS or 70.7VRMS. It shall be possible to configure the module for control of motor contactors and AC voltages to 115VAC.
  - 1. All controlled circuits shall be power limited at 1.5A, produced by self-restoring thermal components. Units requiring circuit replacement for restoration of outputs are not acceptable.

- a. The module shall report a trouble condition in the event of loss of the primary 24VDC signal operating supply voltage.

## 2.14 EVACUATION SIGNALS

- A. Speakers: Shall be of the polarized 24-VDC type. Speaker shall be UL listed for fire alarm voice evacuation use. Speakers shall be designed to be mounted on a wall, ceiling or other suitable rigid surface and shall be capable of being surface, semi-flush, or flush mounted. Speakers shall be multi-tap. Settings shall be 1/16, 1/8, 1/4, 1/2, 1, 2 or 4 watts.
  1. Speech Intelligibility: The emergency voice communication system shall be designed to meet a Common Intelligibility Scale (CIS) of not less than 0.70.
- B. Strobe Light: Visual notification appliances shall be comprised of a xenon flashtube and be entirely solid state. These devices shall be UL listed and available for ceiling or wall mounting. The unit shall be Texas Accessibility Standards (TAS) compliant with an output no less than 15 candela. The Lexan lens shall be pyramidal in shape to allow better visibility. All strobe lamps and lenses shall be clear. Strobe light candela ratings shall be shown on the fire alarm plans. Contractor is responsible for providing number of strobes and candela sizing per NFPA 72 based on room size and device location. Units shall be installed 80" above finished floor. All strobes within the same line of site shall be synchronized. Provide multi-tap strobes to allow for a full range of candela settings. Settings shall be 15/75, 30/75, 75 or 110 candela. Circuits for strobes shall allow for capacity to increase strobe intensities one setting for all strobes. Provide spare devices equal to 1% of the total number of new devices provided for this project.
- C. Speaker/Strobe combination: Units shall meet TAS. Audio/Visual units shall provide a common enclosure for the fire alarm audible and visual alarm devices. The housing shall be designed to accommodate either horns, bells, chimes or speakers. The unit shall be complete with a tamper resistant, Lexan lens visible from a 180-degree field of view. Strobe shall be multi-tap type to allow for a full range of candela. Xenon strobe shall provide 4-wire connection to insure properly supervised in/out system connection. Unit shall be complete with all mounting hardware including back box. Audio/visual unit shall be UL listed for its intended purpose. Speaker shall be multi-tap type to allow for different audio settings. Provide spare devices equal to 1% of the total number of new devices provided for this project.
- D. The evacuation signal device shall be available in flush, semi-flush, or surface mount versions as required for signal locations shown on the contract documents. Devices shall be mounted using a listed outlet box. Signals shall be available in visual and audio/visual to satisfy all required project applications. Device housing shall be white and without any label.

## 2.15 SECURITY INTERFACE TERMINAL BOX

- A. The interface terminal box shall be a lockable continuous hinge cover NEMA Type 4 enclosure. The cover of the enclosure shall be labeled to identify its function.

- B. Dual screw barrier type terminal strips shall be provided within the interface terminal box. Terminals shall be provided for each interface output from the fire alarm system and the manual unlock key switch. All terminals shall be labeled to identify their function.
- C. The output contacts from the fire alarm system shall be rated for 1A at 120V.

### **PART 3 - EXECUTION**

#### **3.1 DESIGN AND INSTALLATION DRAWINGS**

- A. Show a general layout of the complete system including equipment arrangement. It shall be the responsibility of the fire alarm contractor to verify dimensions and assure compatibility with all other systems interfacing with the fire alarm system.
  - 1. Identify on the drawings, conduit and conductor sizes and types with number of conductors in each conduit. Provide each conduit and device with a unique identification. For addressable alarm initiation devices, the system identifier shall be the system address for that device. Signals shall be sequentially numbered as the address of the controlling module.
  - 2. Indicate on the point to point wiring diagrams, interconnecting wiring within the panel between modules, and connecting wiring to the field device terminals.
  - 3. Provide mounting details of FACP and other boxes to building structure, showing fastener type, sizes, material and embedded depth where applicable.

#### **3.2 INSTALLATION**

- A. All work shall be in compliance with Section 1.3, REFERENCED STANDARDS contained herein.
- B. All work shall be accomplished in a professional and workmanship like manner.
- C. A qualified fire alarm technician shall supervise the installation, testing and adjustment of the fire alarm equipment.
- D. The Fire Alarm contractor is responsible for patching and repairing walls and/or ceilings penetrations made by the fire alarm contractor or his/her designated subcontractor(s) where wiring, conduit or devices are installed or removed. Holes in smoke barrier or fire-resistive construction walls and ceilings shall be properly sealed with approved U.L. listed materials and/or U.L. listed fire stop/smoke devices designed for such use or location. The smoke or fire stop material or devices shall be approved by the wiring manufacturer for compatibility with the wiring material it contacts. Whichever method is approved, it shall be installed per the U.L. listing of the specific product.

#### **3.3 CONDUIT**

- A. All wiring shall be installed in conduit, minimum  $\frac{3}{4}$ " EMT. Plenum rated cable with J-hooks may be used above ceilings.

### 3.4 ENCLOSURES AND WIRING DEVICES

- A. Wiring enclosures and equipment device boxes shall be sized and installed per NFPA 70.
  - 1. All fire alarm J-Boxes and their covers shall be painted red. The cover shall be labeled "FA System" in minimum  $\frac{1}{2}$  inch letters with permanent black ink.

### 3.5 CONDUCTORS

- A. All fire alarm systems shall be installed in such a manner that a failure of any single initiating device or single open in an initiating circuit conductor will not interfere with the normal operation of other such devices. All signaling line circuits (SLC) shall be installed such that a single open will not interfere with the operation of any addressable devices (Class A). Outgoing and return SLC conductors shall be installed in accordance with NFPA 72 requirements for Class A circuits and shall have a minimum of four feet separation horizontal and one foot vertical between supply and return circuit conductors. The initiating device circuit (IDC) from a signaling line circuit interface device may be wired Class B, provided the distance from the interface device to the initiating device is ten feet or less. NAC circuits shall be wired Class A.
- B. Each conductor shall be identified as shown on the shop drawings with wire markers at every splice and terminal point. Attach permanent wire markers within 2 inches of each wire termination. Marker legends shall be visible.
  - 1. All wiring shall be supplied and installed in compliance with the requirements of the National Electric Code, NFPA 70, Article 760, and that of the manufacturer.
  - 2. Wiring for analog loop circuits and speaker circuits shall be minimum 18 AWG twisted. Wiring for strobe circuits shall be a minimum 14 AWG.
  - 3. Wiring shall be installed without splices or joints. Connections shall be made to the device terminals or equipment terminal strip.
  - 4. Crimp-on type spade lugs shall be used for terminations of stranded conductors to binder screw or stud type terminals. Spade lugs shall have upset legs and insulation sleeves sized for the conductors.
- C. Permanently label or mark each conductor at each end and at all terminals with permanent alphanumeric wire markers.
- D. Provide Type CI, 2 hour rated circuit integrity cable for riser wiring and wherever else required per code.

### 3.6 CERTIFICATE OF COMPLIANCE

- A. Complete and submit to the Owner in accordance with NFPA 72.

### 3.7 FIELD QUALITY CONTROL

#### A. Testing, General.

1. All intelligent analog devices shall be tested and logged for correct address and sensitivity using test equipment specifically designed for that purpose. These devices and their bases shall be tagged with adhesive tags located in an area not visible when installed, showing the system address, initials of the installing technician and date.
2. Wiring runs shall be tested for continuity, short circuits and grounds before system is energized. Resistance, current and voltage readings shall be made as work progresses.
  - a. A systematic record shall be maintained of all readings using schedules or charts of tests and measurements. Areas shall be provided on the logging form for readings, dates and witnesses.
  - b. The acceptance inspector shall be notified before the start of the required tests. All items found at variance with the drawings or this specification during testing or inspection by the acceptance inspector, shall be corrected.
  - c. Test reports shall be delivered to the acceptance inspector as completed.
3. All test equipment, instruments, tools and labor required to conduct the system tests shall be made available by the installing contractor. The following equipment shall be a minimum for conducting the tests:
  - a. Ladders and scaffolds as required to access all installed equipment.
  - b. Multimeter for reading voltage, current and resistance.
  - c. Intelligent device programmer/tester.
  - d. Laptop computer with programming software for any required program revisions.
  - e. Two-way radios, flashlights, smoke generation devices and supplies.
  - f. A manufacturer recommended device for measuring air flow through air duct smoke detector sampling assemblies.
  - g. Decibel meter.
4. In addition to the testing specified to be performed by the installing contractor, the installation shall be subject to test by the acceptance inspector.
5. System wiring: fire alarm circuits shall be tested for continuity, grounds, and short circuits.

#### B. Acceptance testing.

1. A written acceptance test procedure (ATP) for testing the fire alarm system components and installation will be prepared by the Acceptance Inspector in accordance with NFPA 72, and this specification. The contractor shall be responsible for the performance of the ATP, demonstrating the function of the

system and verifying the correct operation of all system components, circuits, and programming.

2. A program matrix shall be prepared by the installing contractor referencing each alarm input to every output function affected as a result of an alarm condition on that input. In the case of outputs programmed using more complex logic functions involving "any", "or", "not", "count", "time", and "timer" statements; the complete output equation shall be referenced in the matrix.
3. A complete listing of all device labels for alpha numeric annunciator displays and logging printers shall be prepared by the installing contractor prior to the ATP.
4. The acceptance inspector shall use the system record drawings in combination with the documents specified under Paragraph 3.1 during the testing procedure to verify operation as programmed. In conducting the ATP, the acceptance inspector shall request demonstration of any or all input and output functions. The items tested shall include but not be limited to the following:
  - a. System wiring shall be tested to demonstrate correct system response and correct subsequent system operation in the event of:
    - 1) Open, shorted and grounded intelligent analog signaling circuit.
    - 2) Open, shorted and grounded network signaling circuit.
    - 3) Open, shorted and grounded conventional zone circuits.
    - 4) Open, shorted and grounded speaker, telephone circuits.
    - 5) Intelligent device removal.
    - 6) Primary power or battery disconnected.
    - 7) Incorrect device at address.
  - b. System evacuation alarm indicating appliances shall be demonstrated as follows:
    - 1) All alarm notification appliances actuate as programmed
    - 2) Audibility and visibility at required levels.
  - c. System indications shall be demonstrated as follows:
    - 1) Correct message display for each alarm input at the control panel, each remote alphanumeric display and each CRT terminal.
    - 2) Correct annunciator light for each alarm input at each annunciator and color graphic terminal as shown on the drawings.
  - d. Secondary power capabilities shall be demonstrated as follows:
    - 1) System primary power shall be disconnected for a period of time as specified herein. At the end of that period, an alarm condition shall be

- created and the system shall perform as specified for a period as specified.
- 2) System primary power shall be restored for forty-eight hours and system charging current shall be normal trickle charge for a fully charged battery bank.
  - 3) System battery voltages and charging currents shall be checked at the fire alarm control panel using the test codes and displayed on the LCD display.
5. In the event of system failure to perform as specified and programmed during the ATP procedure, at the discretion of the acceptance inspector, the test shall be terminated.
- a. The installing contractor shall retest the system, correcting all deficiencies and providing test documentation to the acceptance inspector.
  - b. In the event that software changes are required during the ATP, a utility program shall be furnished by the system manufacturer to compare the edited program with the original. This utility shall yield a printed list of the changes and all system functions, inputs and outputs effected by the changes. The items listed by this program shall be the minimum acceptable to be re-tested before calling for resumption of the ATP.
  - c. The acceptance inspector may elect to require the complete ATP to be performed again if, in his opinion, modifications to the system hardware or software warrant complete re-testing.

### 3.8 DOCUMENTATION

- A. System documentation shall be furnished to the owner and shall include but not be limited to the following:
1. System record drawings and wiring details including one set of reproducible masters and drawings on CD ROM in a DXF format suitable for use in a CAD drafting program.
  2. System operation, installation and maintenance manuals
  3. Written documentation for all logic modules as programmed for system operation with a matrix showing interaction of all input signals with output commands.
  4. Documentation of system voltage, current and resistance readings taken during the installation, testing and ATP phases of the system installation.
  5. System program showing system functions, controls and labeling of equipment and devices. Also provide a copy of the system files on CD ROM in PDF format.

### 3.9 TEST EQUIPMENT

- A. Refer to Division 01 for General commissioning requirements.
- B. The Contractor shall furnish all test equipment as required to program devices and test the system, specifically an intelligent device tester and programmer.

3.10 INTERFACE TERMINAL BOX

- A. The fire alarm system contractor shall install the interface terminal box at the main fire alarm control panel in a readily accessible location no more than 8'-0" A.F.F.
- B. The fire alarm contractor shall wire from the fire alarm system to the interface terminal box.
- C. The security contractor shall wire from the security system to the interface terminal box.

3.11 INTERFACE CONDUIT, POWER AND WIRING

- A. The fire alarm contractor shall provide all conduit, power and wiring required for the installation of the terminal box, manual unlock switch and interfacing to the fire alarm system. All wiring installations shall meet NFPA 70 and be UL listed for the fire alarm applications.
- B. The security contractor shall provide all wiring from the interface terminal box to the security system. All wiring installations shall meet NFPA 70 and be UL listed for the fire alarm applications.

3.12 WARRANTY AND SERVICES

- A. The contractor shall warrant the entire system against mechanical and electrical defects for a period of 18 months. This period shall begin upon completed certification and test of the system.
- B. During the warranty period, the fire alarm system subcontractor or manufacturer shall provide at no additional charge the inspection, parts, maintenance, testing and repair to maintain the system in full compliance with the requirements of NFPA 72.
- C. A NOTIFIER trained technician in the employ of the installing fire alarm contractor shall furnish training to the Owner's employees on operation of the fire alarm system.
  - 1. Training in the receipt, handling and acknowledgement of alarms.
  - 2. Training in the system operation including manual control of output functions from the system control panel.
  - 3. Training in the testing of the system including logging of detector sensitivity, field test of devices and response to common troubles.
  - 4. The total training requirement shall be a minimum of 6 hours but shall be sufficient to cover all items specified.

**END OF SECTION**



## APPENDIX D: DISTRIBUTED LEARNING VIDEOCONFERENCE ROOM DESIGN CONSIDERATION

### UNT Classroom Standards Overview

The Division of Digital Strategy & Innovation Technology department, or DSI-Tech (formerly known as Classroom Support Services), (provides learning environment, room based, technology design and integration services to) designs, installs, and supports audiovisual technology for the purposes of instructional activities in all type 110 general purpose classrooms for the university. Historically videoconferencing had been considered a specialized room type with dedicated hardware and design standards. Technology has evolved to meet the changing needs of instructors and students. Videoconferencing/web conferencing/digital communications has expanded into our classroom design standards.

#### Facilities Design

DSI-Tech will work with the project architect to specify the layout and design of a physical space to be used with audiovisual equipment. DSI-Tech will evaluate an existing space which is being considered for use as a classroom against the industry standards, university standards and state requirements for the space. Our evaluation of an existing space will result in either a qualification of the room as "functional", with a list of necessary modifications, or determined to be a poor candidate for an AV system.

#### Systems Design

DSI-Tech's base features of a standard classroom have evolved over the years to meet the needs of instructors from many disciplines. Below are standard presentation and communication technology features included in all general-purpose classrooms:

##### Traditional Classroom Style

The teacher delivers a standard curriculum to the students. Presentation style classroom. Front facing audience towards the presenter. The presentation area will include a talk board, video reinforcement, and access to AV technology. The area will have technology to support face to face, virtual synchronous and asynchronous capabilities.

##### Traditional Classroom Technology

- Projection system
- Presentation computer, monitor, keyboard, and mouse
  - Computer support provided by DSI-Tech w/ standardized applications
  - Provides audiovisual systems control via an always-on application
  - Wireless BYOD screen sharing software for instructors and/or students

- Both a privacy and preview monitor are available (except in rare cases of limited workspace)
- Auxiliary input for BYOD connection to the audiovisual system
- Audio system for program audio and speech reinforcement
- Lapel microphone that may be used in digital communications and for speech reinforcement
- At least one PTZ camera, for capturing the instructor in digital communications or lecture recordings
- Document camera, which may also be used in digital communications or recordings via the computer.

### Active Learning Classroom

Collaboration learning style classroom. Students participating or interacting in the learning experience. Hands-on activities, discussions, problem solving, and group work are examples of active learning. Presenters/participants can arrange the furniture in the area to reflect a traditional classroom or arrange the furniture for collaboration. Utilizing the in-room technology combined with web-based technology, mixed delivery course design is possible.

### Active Learning Classroom Technology:

- Projection system
- Presentation computer, monitor, keyboard, and mouse
  - Computer support provided by DSI-Tech w/ standardized applications
  - Provides audiovisual systems control via an always-on application
  - Wireless BYOD screen sharing software for instructors and/or students
  - Both a privacy and preview monitor are available (except in rare cases of limited workspace)
- Auxiliary input for BYOD connection to the audiovisual system
- Audio system for program audio and speech reinforcement
- Lapel microphone that may be used in digital communications and for speech reinforcement
- At least one PTZ camera, for capturing the instructor in digital communications or lecture recordings
- Document camera, which may also be used in digital communications or recordings via the computer.
- Flexible tables and chairs that can be arranged in the classroom
- Displays for collaboration
  - Control system allows displays to be used for presentation support or collaboration with BYOD

- BYOD connects to display via wireless screen sharing software

### Maintenance

DSI-Tech performs maintenance and support for audiovisual systems that have been designed by DSI-Tech. Regular inspections and maintenance are performed every 90 days (about 3 months) or 250 operating hours. Additionally, equipment is monitored remotely by trained personnel during normal class hours (typically 8am to 8pm) for correct operation and surveilled by UNT Police after hours via a monitoring system.

### Roles and Responsibilities

DSI-Tech is responsible for:

- Designing audiovisual (AV) system layout and placement
- Ordering and receiving AV equipment, and delivering OFCI equipment to job site
- Pulling and terminating cable from instructor equipment rack to each device (speakers, projectors, displays, etc.) as required
- Installing AV equipment (cameras, projectors, speakers, displays, etc.) onto their respective mounts
- Installing AV equipment rack into designated location
- Conducting AV performance verification checks and commissioning the system

Contractor and/or UNT Facilities are responsible for:

- Installing electrical outlets where specified, and connecting hardwired equipment to electrical system (if such equipment is utilized in the design)
- Installing any cable track, cable boxes, conduits, J-hooks, wire hangers, cable trays, or other cable-concealing or cable support systems necessary by UNT building requirements and local safety codes
- Installing supporting structure necessary for attaching audio visual hardware (provided by DSI-Tech) to structure in accordance with safety code
- Mounting and installing projection surfaces (projector screens, manual or motorized) securely to building structure in accordance with the system design, layout, and local safety codes
- Providing any custom-built lectern or cabinetry to conceal cabling or to provide additional workspace
- Providing all additional hardware (metal framing channel (Unistrut), concrete anchors, bolts, washers, all thread, etc.) required for any of the above tasks if not included with equipment or associated mounting kit

DSI-Tech, contractor, and UNT Facilities will coordinate on the timing and execution of the above tasks to ensure adherence to project timelines. In general, the following timelines are preferred:

- Before drywall installed:
  - DSI-TECH Confirms with contractor the placement of wall box(es) and conduit(s)
  - DSI-TECH Confirms location and placement of electrical/networking and in-wall backing board or housings
- Before ceiling grid installed:
  - CONTRACTOR Complete installation of structural mounting and support for AV equipment mounts
  - CONTRACTOR Complete installation of cable support systems (J-hooks or conduit)
  - CONTRACTOR Complete installation of projection screen (only if mounted in-ceiling)
  - DSI-TECH Pull cable through raceways, J-hooks, and conduits
- ONLY AFTER the space is made dust-free:
  - DSI-TECH Terminates cable pulls
  - DSI-TECH Installs AV equipment

## Requirements for Classrooms

The DSI-Tech department oversees the design, integration, and maintenance of classroom technology. Our efforts create and support an audible and visual technology reinforced learning environment. The AV technology in the classroom is in place to help the instructor reach their teaching goals and to help the student reach their learning goals.

All the areas have installed equipment with intuitive control interfaces. Presenters can utilize the technology to display information onto a projector screen and/or displays. There is an in-room computer and document camera available. A presenter can also bring their own device and connect to the in-room equipment to share content. A wireless microphone and mounted speakers facilitate reinforced audio that amplifies the presenter's content and voice. Cameras are installed to support video capture of presentations.

Classroom Technologies are designed to support in-room and connected audience members. An in-room camera will send the video to the presenter's preferred destination (i.e., Zoom, Teams, Canvas, etc.). Audio is routed to both in the room and to the camera capture software.

## Decor

The best decor is plain and simple. Keep the area within the camera's view (usually the front of the room) uncluttered. Extraneous objects such as mirrors, artwork,

plants, and fans cause the camera view to be cluttered and distracting to remote participants and learners. The best wall color is a neutral non-white color, such as medium gray. Avoid wall treatments with patterns. These also can cause undesirable visual artifacts in a web conference.

### **Acoustics**

Audio reinforcement technology is provided to support in room and connected audio. Audio quality is one of the most important contributing factors to a favorable learning experience, therefore good acoustics are important. The physical environment has a significant impact on the performance of this equipment. Of particular concern is reverberation - the effect of sound reflecting from hard surfaces. One of the best ways to minimize the harmful effects of reverberation is to coat floors, ceilings, and walls with sound absorbing materials, such as carpet, acoustical ceiling grid, and sound-absorbing acoustical panels. Speakers and microphones should be installed with a focus upon distance between installed components (speakers, microphones, projectors, etc.). In addition to minimizing reverberation, it is also important to isolate the room from external noise sources, such as fans, HVAC (Heating, Ventilating, and Air Conditioning), water pipes, noisy lab equipment, telephones, and street noise. Consider installing audio in the area in a way that limits audio bleeding into other areas (focus upon containing the audio in the room).

### **Room Type/Furniture Layout**

The room furniture should be best suited to the desired capacity and sightlines of the room. Larger rooms should have a sloped or tiered floor so that all students may have an unobstructed view of the projection surface. Lecture halls may have stadium-style seating which should be staggered as well to prevent students looking at the back of another person's head. The fixed bar-style row desk with attached swivel seating is discouraged due to their tendency to be easily damaged and unaccommodating to individuals with certain body types. Moveable tables and chairs are preferred.

### Room system overview

UNT's classroom instructional systems are built around a common set of equipment that meets our minimum technical requirements. These standards were designed for a range of applications, levels of service and quality dependent upon their purpose. DSI-Tech will set and maintain the standard technical level for equipment in university classrooms and requires this equipment, e.g., computers, mics, cameras, etc. for end user familiarity, as well as to enable bulk purchase and standardized support, replacement, and serviceability from the department.

### **Cost variable accessories**

Rooms are designed around common technical requirements, and most cost variations are due to the size of the room and necessary audiovisual reinforcement (number of displays, speakers, etc.). In certain cases, an additional camera may be

installed in areas where Space Management and the Registrar have agreed to use for distance education where rooms are paired between cities.

Classroom Instructional System Hardware Cost *Estimates*

<b>Small Room System</b>	<b>Medium – Large Room System</b>
Participants: 20 - 40	Participants: 40 - 200
Cost range: \$15,000 - \$30,000	Cost range: \$35,000 - \$50,000
Typical Equipment	Typical Equipment
<ul style="list-style-type: none"> <li>• Computer</li> <li>• Projector (or large flat panel display)</li> <li>• Projection surface</li> <li>• PTZ camera</li> <li>• Wireless microphone system</li> <li>• Audio-video presentation switcher</li> <li>• Amplifier (may be integrated)</li> <li>• Ceiling speakers</li> <li>• Auxiliary BYOD input</li> </ul>	<ul style="list-style-type: none"> <li>• Small room system equipment, plus:</li> <li>• Additional projectors and displays, as necessary for visual reinforcement</li> <li>• Additional speakers</li> <li>• Additional amplifiers</li> <li>• Second camera (if distance education)</li> <li>• Desk-mounted document camera</li> <li>• Ceiling microphones</li> </ul>

Physical Room Characteristics & Other Considerations

It is always easiest to start with new constructions which will afford the greatest degree of flexibility in creating an ideal classroom. There are several unique considerations to keep in mind when considering a room for a videoconference installation.

Location of network jacks

The videoconference equipment is typically housed in an instructor podium which must be connected to the data network and electricity. These jacks should be located adjacent to the instructor podium to minimize cabling lengths and ensure safety. A cable box and conduit are required to run audiovisual cabling into the ceiling plenum or through the foundation. The diameter and number of conduits must be coordinated between designer, contractor, and DSI-Tech.

Location of doors

The orientation of equipment in the room is such that the instructor station is placed in one corner near the front of the room. The front wall adjacent to the instructor has one or two large projections screens attached. The location of the doors should accommodate the placement of this equipment and ensure that participants entering the room do not interfere with class which may be in progress.

## Carpeting

Covering the floor with carpeting helps to decrease the ambient sound in the room and eliminates such distractions as chairs being moved across the floor.

## Security

Some components of a classroom technology installation are portable and have consumer appeal for non-videoconference applications. To ensure reliability of the system, it is necessary to secure the components by using some proprietary fasteners, locking mounts and other security techniques.

Equipment is monitored remotely by trained personnel during normal class hours (typically 8am to 8pm) for correct operation and surveilled by UNT Police after hours for presence via a monitoring system.

## Sight lines

The goal is to provide the best view of the display units to all videoconference participants. The widest viewing angle for any participant should be 35 degrees off the center of the display units. No columns or other physical obstructions should be located between the participants and the display units.

## Size

- Ideal dimensions are 1.25:1 (depth: width); maximum dimensions are 1.5:1 for a lecture-style layout (depth: width).
- Minimum ceiling height is dictated by screen height (see also "Screen" below).
- REFER TO FIGURE DRAWING OF TYPICAL CLASSROOM LAYOUTS

## Seating

- ADA-compliant aisle widths.
- Tables and chairs are preferred.
- All seats within 90 degrees of screen center (no more than 45 degrees to right or left).
- The front row of seats should be no closer than 1.5 X screen width.

## Screen

- Screen dimensions must accommodate format as wide as 16:9
- Screen height = range of 1/5 to 1/7 distance from screen to last seat
- Screen bottom = 4' above floor.
- Offset as needed.

## Data projector installation

- Clear path from projector mount point to both sides of screen (no protruding sprinkler heads, exit signs, air ducts, lights).
- No lights shining right in front of projector screen, directly at projector, or immediately behind projector.

- One 110-volt electrical circuit with two outlets installed in ceiling tiles for projector. Projector mount point varies by projector model and projector screen size.
- No air ducts, conduits, or lights at or above projector mount points.
- No air blowing onto projection screens.

### Teaching area

- One 110-volt electrical circuit, minimum quadplex outlet within lectern or at specified location
- Instructor lectern containing AV equipment is to be located next to sidewall near front and outside of front screen viewing angle with minimum 3' egress on 3 sides. Clear path for wiring from podium to jacks/outlets.

### Lighting/Electrical

- All electrical circuits need to be dedicated and on the same isolated ground.
- The lighting near the screens should have a separate on-off switch. No light should fall directly on the projection screens. The instructor area should be well-lit with sources in front of and overhead.
- There are four data network jacks adjacent to the instructor lectern electrical outlets. One 110-volt electrical outlet within 3' of instructor podium. One 110-volt electrical outlet, mounted in ceiling tile, located within 3' of each projector(s).

### Writing surface

- Matte glass boards at the front of the room.
- Marker trays to be installed along the length of the board, or at least one near the instructor station and opposite side of the room.

### Sound

- Speakers, microphone, and sound system are integrated with the computer so that any soft-coded may be used (Zoom, Teams, etc.)
- Quiet-closing doors.
- Quiet air-handlers.
- Room insulated from outside and building/mechanical noise.
- Acoustic wall and floor treatments as required to minimize sound reflection.

### Miscellaneous

- Windows must have room darkening and/or blackout covers available.
- Trash cans.
- Chair rails.



## APPENDIX E: GUIDE FOR THE STANDARDIZATION OF THE CAMPUS AUTOMATION SYSTEM

### UNT Controls and Automation Standards

The University of North Texas Denton Campus Facilities utilizes the Schneider Electric building automation control and monitoring system StruxureWare, Vista™ 5 and I/NET Seven with the associated interface hardware. Schneider Electric StruxureWare is a software suite of building management tools that control and monitor our building systems. It is based on open systems technology based on the LonWorks® [technology](#) and NL220 protocol. New installations and construction shall be specified with Schneider Electric StruxureWare. The legacy building management systems are Vista™ 5 and I/Net Seven and are present in a number of existing buildings.

1. All end devices must be compatible with the Schneider Electric StruxureWare software front end and subsequent releases. All UNT programming or adjustments of any end device after installation shall be done through the Schneider Electric StruxureWare program and not require a secondary program.
2. Existing buildings operating with Schneider Electric Vista™ 5 or I/NET Seven software and hardware will be upgraded, where possible, with newer controllers that will interface more fully with Schneider Electric StruxureWare.
3. The programmable network devices, control panels, controllers will be provided and specified by Schneider Electric building controls.
4. Full functionality and seamless interface to the controlled equipment through Schneider Electric StruxureWare is expected especially fume and laboratory hood controls & valves, chillers, boilers, fans, VFDs, AHUs, VAVs, lighting, metering, etc.
5. Each VAV air-handling unit will have a Dedicated Control Unit as per current UNT Spec. Only points associated with that unit will be terminated in the DCU plus IO unless for lighting, exhaust, or other not associated with another unit.
6. Each VAV air handling unit will have 1 or more DCU controllers which will perform the data management functions for the VAV for a specific unit that the terminal units are associated to. **If an air handler serves more than one floor, it will have a DCU on each floor with only that floors VAV terminals connected to it.** Max of 10 terminal units per 401: B. **Each VAV terminal will have a supply air sensor if the terminal unit has any heating stages.**
7. Each single zone, double duct, and most multi zone air-handling unit will have their own controller but some of the multi zone air-handling unit may require multiple controllers. No more than 1 unit will be terminated to a base controller.
8. Each single zone CAV, VAV or face and bypass unit will have a supply air sensor.

9. Each air-handling unit will have a return air if the ductwork is continuous from the space back to the unit. Multi-zone units will have cold deck and hot deck sensors installed in associated decks. Return Air Temperature Sensors will be installed as a standard. Mixed air temperature sensors will not be used as a standard, unless the unit is being served by another unit (an example of this would be a dedicated outside air unit [1] serving another unit [2] – then the mixed air of 2 is really the supply air of 1).
10. If safety device feedback is standard, the different devices (i.e.: smoke detector, freeze stat, high pressure cutout, etc.) will be a common safety circuit input to the controller. When a safety goes into alarm, **only** that safety's feedback will be in alarm in the controller (safeties will be wired in series to pull in a relay for status to the controller). Each AHU control panel will have a service input switch to reset any safeties and allow local personnel to disable the control of the unit. Hardwire safeties will go to the motor controller and maintenance feedback from safeties to DCU. This switch must have a label indicating that this switch is only a means of EMS shut-down/reset, not intended as a service disconnect.
  - a. Every VFD will have a LON interface and alarm in the DCU, or the following hardwired points as a minimum:
    - i. VFD Run Indication
    - ii. VFD Speed Feedback
    - iii. VFD Speed Control
    - iv. VFD Start/Stop
  - b. Standard VFD manufacturers acceptable for UNT are ABB and Square D. Exceptions have to be approved.
11. Each chiller, boiler plant, heating system and condenser water system will have its own dedicated DCU plus I/O controller. The Chiller and heating system controller will have a cooling or heating required LED and a plant reset pushbutton mounted on the cabinet door.
12. Each secondary pumping system will have its own dedicated controller.
13. A Zone Override pushbutton station will be provided at the direction of UNT, the purpose of this station will be to enable the local operator to override the scheduling of each unit or grouped zone in a building from 1 location through software. The override duration will be a timed for a default set at 2 hours.
14. An override momentary pushbutton will be installed on the front of the panel for each major zone. See #10 for details.
15. UNT will provide IP addresses.
16. The university standard sequence of operations will be followed and provided by UNT.
17. The university standard wiring termination will be followed. – Done per application.
18. Point names in the software will include the equipment name. This must be coordinated with UNT Facilities and generally is limited to 12 characters.

19. Each controller will be labeled (controller name and equipment name) on the front of the panel door.
20. Each controller will have a graphic printout showing wire termination by point name and wire number. The power source location will also be shown on the drawing (panel and breaker number and IP addresses). The drawing will be mounted inside the panel door in a clear plastic sleeve. There will be a separate Electronic Format file of drawings and bound reference copy.
21. All relays, transducers and other controls which are separated from the controlled device will be mounted in a control cabinet or electrical trough that is accessible without a ladder. This does not include sensors or transmitters which must be installed in a pipe.
22. Each controller panel will have a light switch/110v outlet combination installed. The switch will power down all the transformers in the panel. The 110v outlet will remain powered up with the switch off.
23. The following wire types will be used for the shown functions:

<u>Cable Function</u>	<u>CSI Part #</u>	<u>Jacket Color</u>	<u>Description</u>
-----------------------	-------------------	---------------------	--------------------

24. All wiring in control panels will be installed in open slot wiring duct with snap on covers (Panduit or equal). The panels will be large enough to accommodate all of the hardware without over-crowding.
25. Each controller will have separate controller power and output power transformers.
26. A copy of the controls as-built (record) will be furnished in Visio format on CD or DVD.
27. Two hard copies of the controls as-built (record) will also be furnished.
28. Space temperature sensor shall be determined and approved by UNT for color and type- Submit samples. Non-Occupant Controlled and No Display
29. Graphic pages to follow Vista/NSP standards version 5.x or higher.
30. Wireless networks shall not be used. All networks shall be hardwired and a static IP address will be required by UNT.
31. Five-year plan and system design required for approval.
32. Programming logic to be approved by UNT personnel. Generally, logic will be designed with as few calculations as necessary to accomplish tasks. Prefer use of modules over calculations.
33. Equipment network gateway to be fully functional. Contractor will be responsible for this complete functionality.

34. Hand held device set up will be standardized with Graphics compatible and resolution for devices such as laptops, net books, smart phones, etc.
35. A standard controller cabinet, mounting, color, labeling, lighting and location design and instructions will be provided by UNT or designated representative.

## APPENDIX F: INTERIOR SIGNAGE STANDARDS

### UNT Interior Signage Standards

Removed 12/18/2019

## APPENDIX G: ILLUSTRATIONS, DIAGRAMS, AND STANDARD DETAILS

### UNT Design Details

Figure 1 Crosswalks.....	240
Figure 2 ADA Ramp and Curb Cut Details .....	241
Figure 3 Parking Area Detail.....	242
Figure 4 Entry Treatment Detail .....	243
Figure 5 Planting Detail.....	244
Figure 6 Planting Detail for Hedges .....	245
Figure 7 Planting Detail for Trees.....	246
Figure 8 Planting Detail for Trees on Slope.....	247
Figure 9 Outdoor Solid Waste Front-Load Containers Detail .....	248
Figure 10 Outdoor Solid Waste Container Enclosure Without Gates Detail .....	249
Figure 11 Outdoor Solid Waste Enclosure with Gates Detail .....	250
Figure 12 Bollard Detail.....	251
Figure 13 Bicycle Racks Detail.....	252
Figure 14 Fence Detail .....	253
Figure 15 Building and Parking Lot Sign Post Specification .....	254
Figure 16 Building and Parking Lot Entry Sign Detail .....	255
Figure 17 Interior Signage Plate Details Option 1.....	256
Figure 18 Interior Signage Plate Details Option 2.....	257
Figure 19 Restroom Signage Option 1 .....	258
Figure 20 Restroom Signage Option 2 .....	259
Figure 21 Stairwell and Exit Signage Detail Option 1.....	260
Figure 22 Stairwell and Exit Signage Detail Option 2.....	261
Figure 23 Street Banner Details .....	262
Figure 24 Building Sign Installation Detail .....	263
Figure 25 Emergency Phone Specification 1.....	264
Figure 26 Emergency Phone Specification 2.....	265
Figure 27 Office Standards: Typical A .....	266
Figure 28 Office Standards: Typical B .....	267
Figure 29 Office Standards: Typical C1 .....	268
Figure 30 Office Standards: Typical C2 .....	269
Figure 31 Office Standards: Typical C3 .....	270
Figure 32 Office Standards: Typical D .....	271
Figure 33 Elevator Shunt-Trip Device Policy Statement .....	272
Figure 34 Classroom Lighting Detail.....	273
Figure 35 Electrical Box Mounting Bracket Example .....	274
Figure 36 Handrail Detail .....	275
Figure 37 Sample Signage Schedule.....	276
Figure 38 Parking Lot Sign Placement and Standards.....	277
Figure 39 Accessible Sign Placement and Standards .....	278
Figure 40 Standard Light Pole Specification.....	279

Figure 41 Exterior Emergency Key Cabinet Specification ..... 280  
Figure 42 Primary Power Duct bank 4-Cell ..... 281  
Figure 43 Primary Power Duct Bank 2-Cell ..... 282  
Figure 44 Primary Power Duct bank 2-Cell to Transformer ..... 283  
Figure 45 Secondary Power Duct Bank ..... 284  
Figure 46 Telecommunications Duct bank..... 285  
Figure 47 Telecommunications Duct Bank 4 Cell..... 286  
Figure 48 Shared Duct bank 4 Cell Primary & 4 Cell Telecom..... 287  
Figure 49 AED Wall Cabinet ..... 288  
Figure 50 Standard Light Bollard Specification 1 ..... 289  
Figure 51 Standard Light Bollard Specification 2 ..... 290  
Figure 52 Paver Design..... 291  
Figure 53 Control and Expansion Joints ..... 292

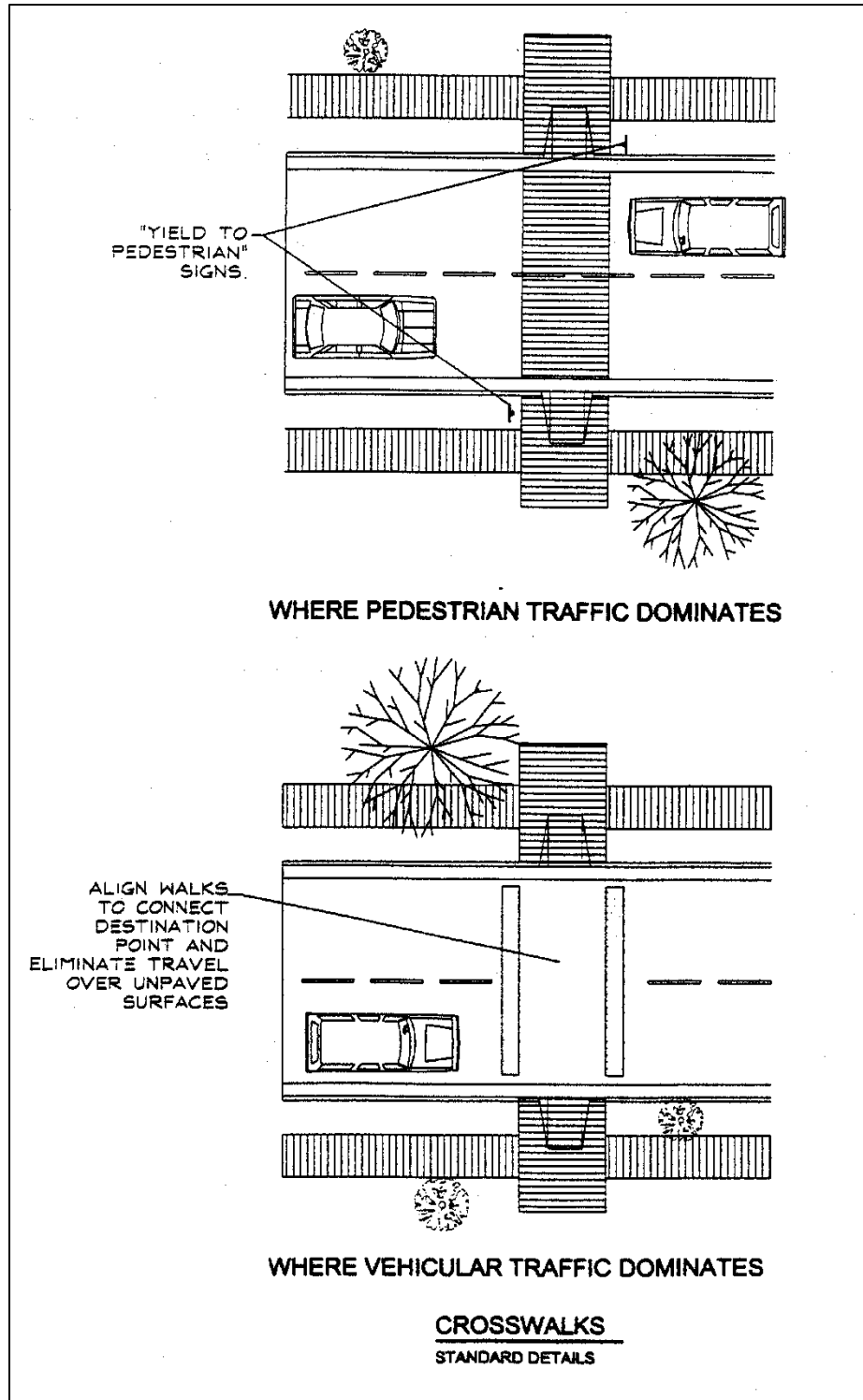
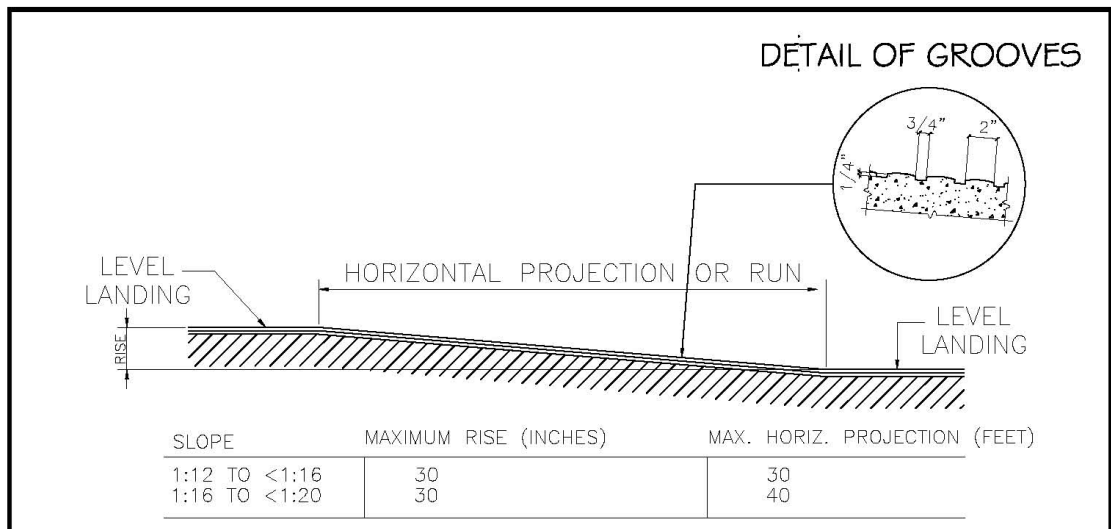

Figure 1 Crosswalks





**COMP. OF A SINGLE RAMP & SAMPLE RAMP DIMENSIONS**

**NOTES :**

1. Surface of curb ramp shall consist of exposed crushed stone aggregate or roughened concrete extending the full width and depth of the curb ramp. For the purposes of warning the full width and depth of curb ramps shall have a light reflective value and texture that significantly contrasts with that of adjoining pedestrian routes. Detectable warning shall consist of grooves 1/4 inch deep and 3/4 inch wide, 2 inches apart and arranged so the water will not accumulate. The grooves shall be detectable underfoot and shall contrast visually with adjoining surfaces, either light-on-dark or dark-on-light.

2. If X is less than 48 in. then the slope of the flared side shall not exceed 1:12

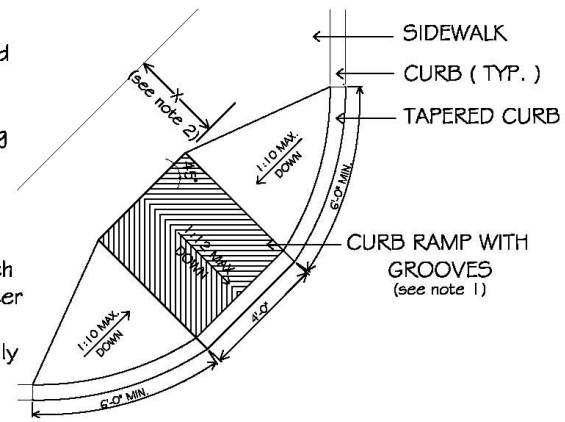

**CURB RAMP LAYOUT**

SHEET <b>1</b> OF 1	TITLE: ADA CURB RAMP SLOPE AND SURFACE	<p><b>UNIVERSITY of NORTH TEXAS</b> OFFICE OF FACILITIES PLANNING AND CONSTRUCTION P.O. BOX 311040, DENTON, TX 76203-1040 940-369-7000</p>	REV #	DESCRIPTION	DATE	BY
	SCALE: N.T.S.    DATE: 05-20-04    BY: K.A.B.		1	ADDED DETAIL OF GROOVES	06-07-04	K.A.B.
			2	FLARED SIDE SLOPES NOTE	06-11-05	H.S.

Figure 2 ADA Ramp and Curb Cut Details

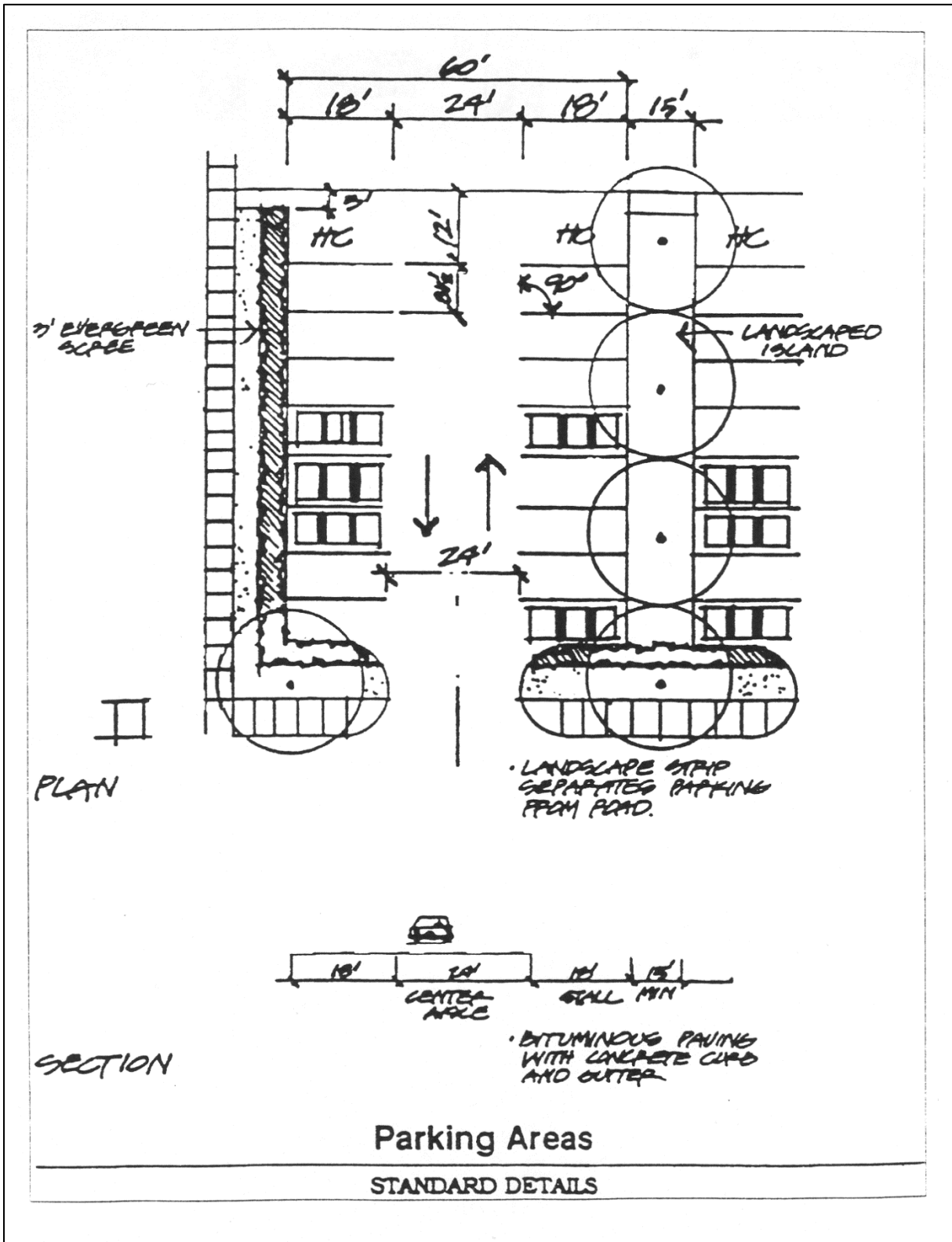

Figure 3 Parking Area Detail

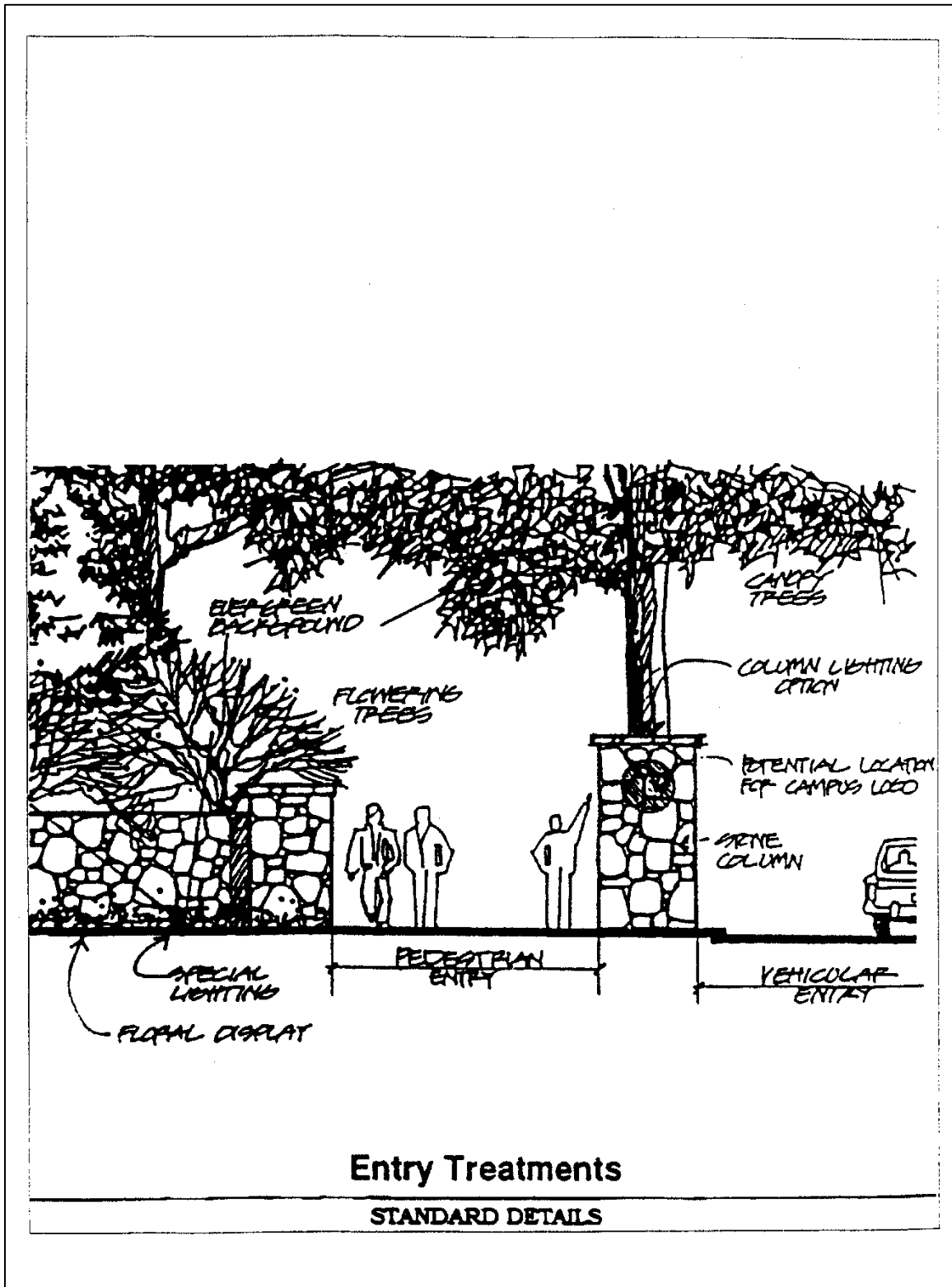

Figure 4 Entry Treatment Detail

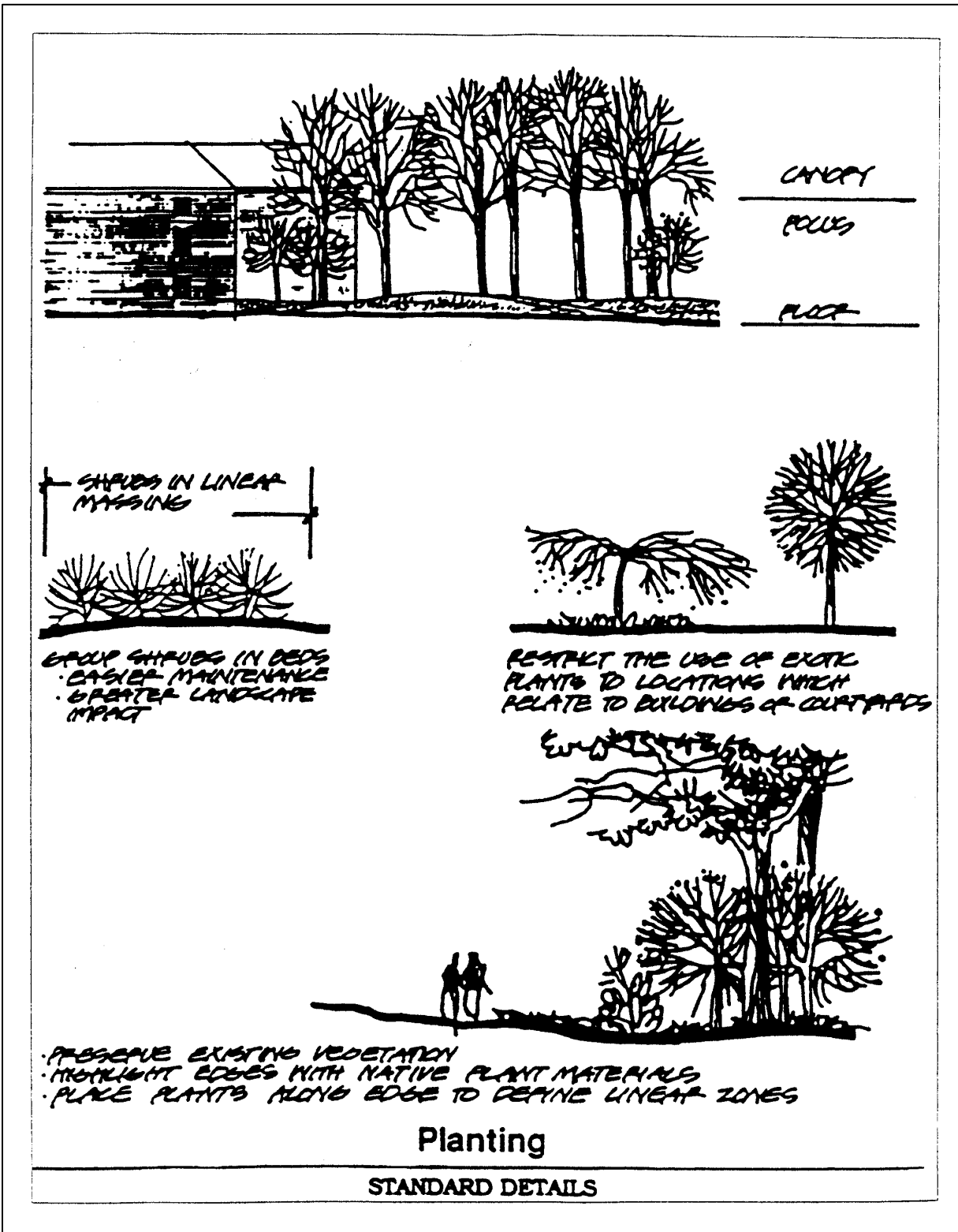

Figure 5 Planting Detail

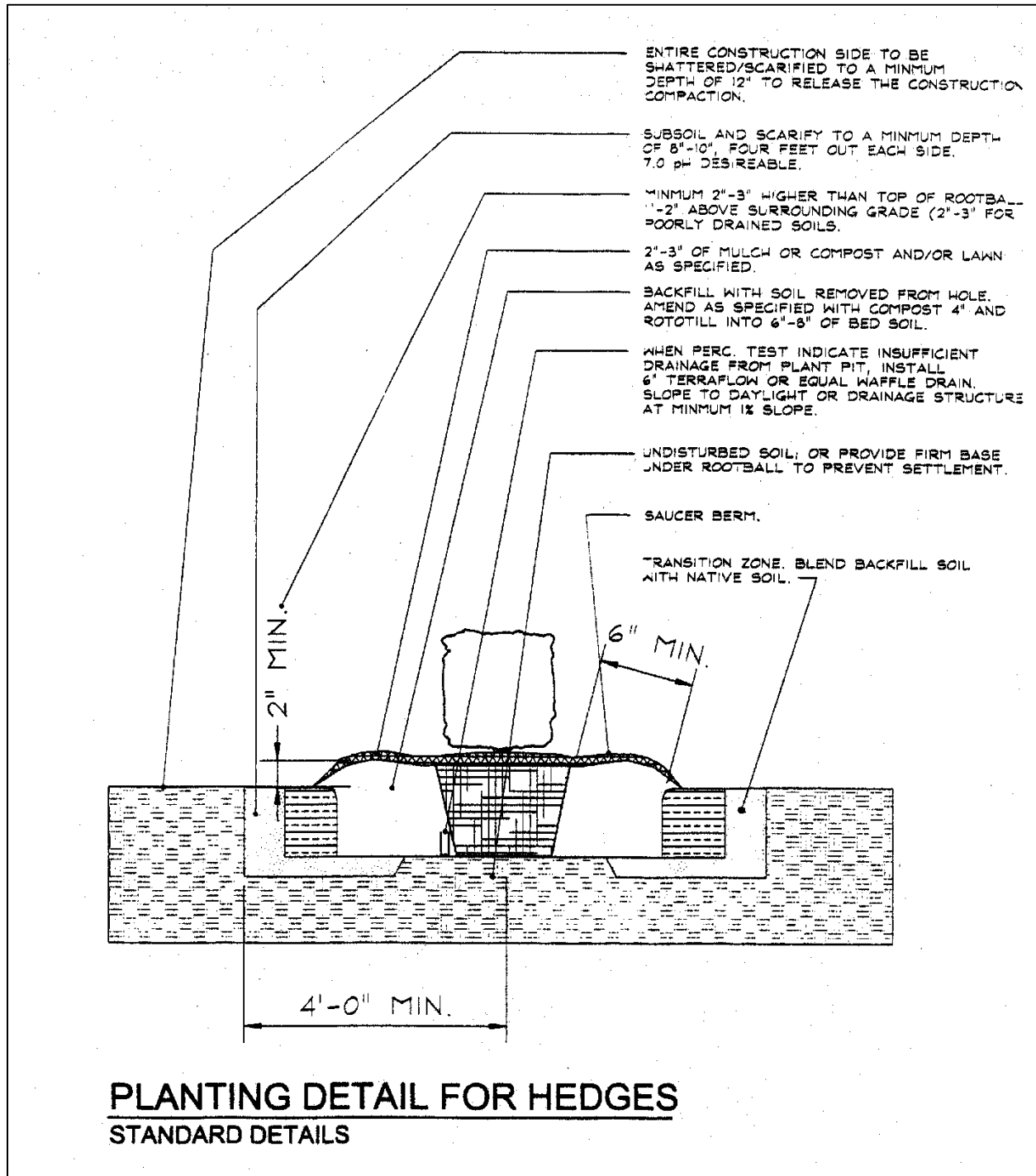

Figure 6 Planting Detail for Hedges

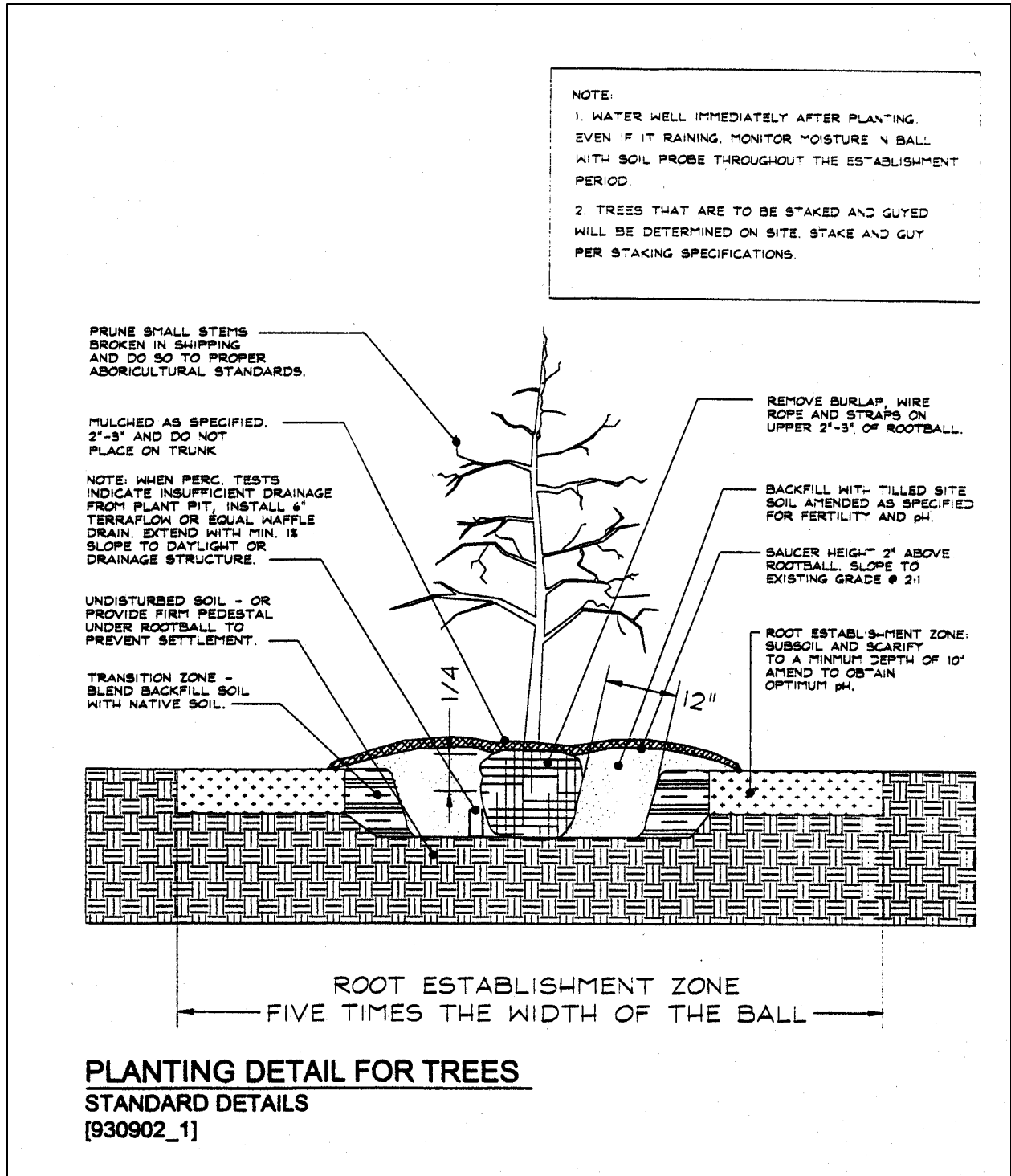

Figure 7 Planting Detail for Trees

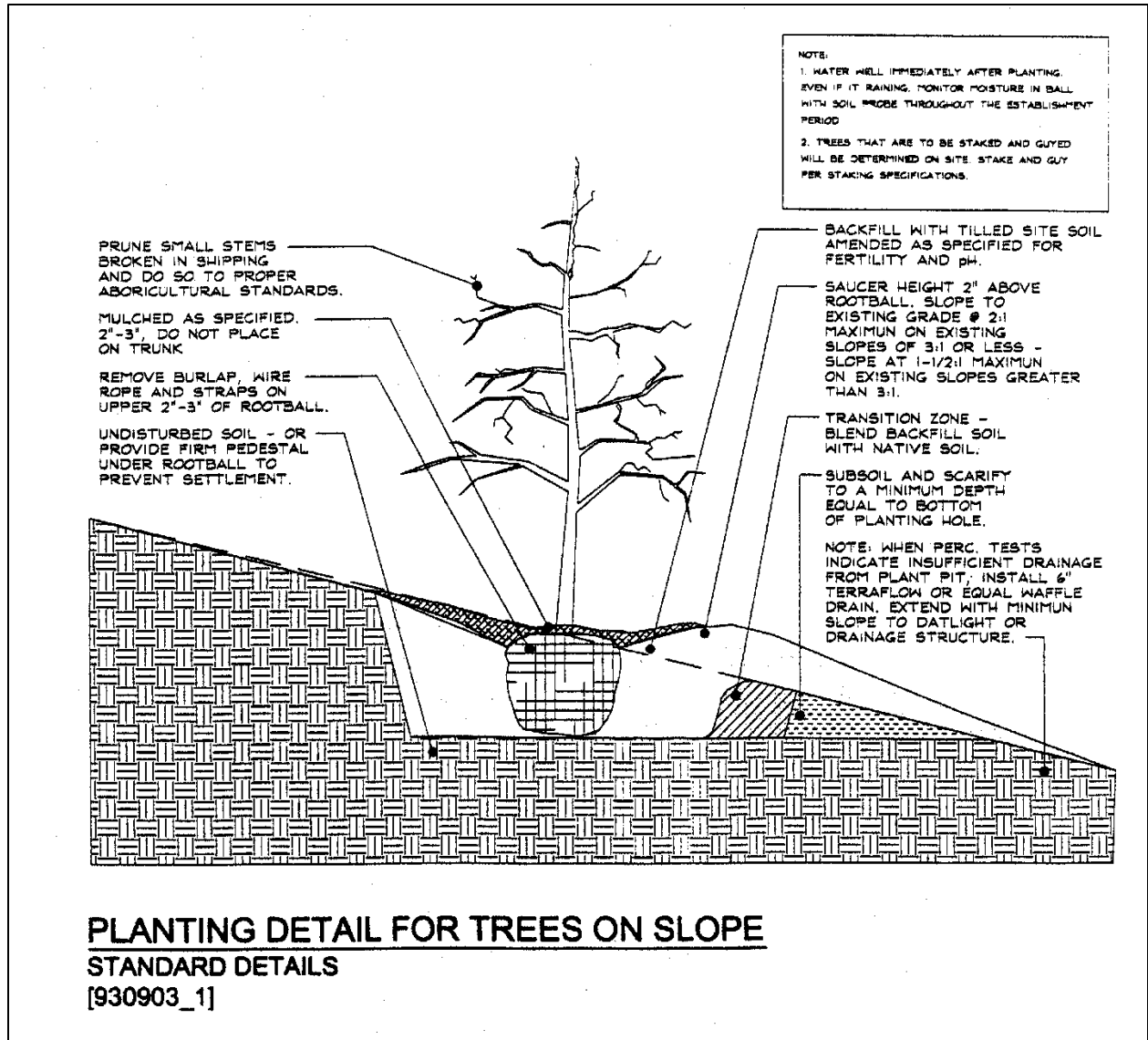

Figure 8 Planting Detail for Trees on Slope

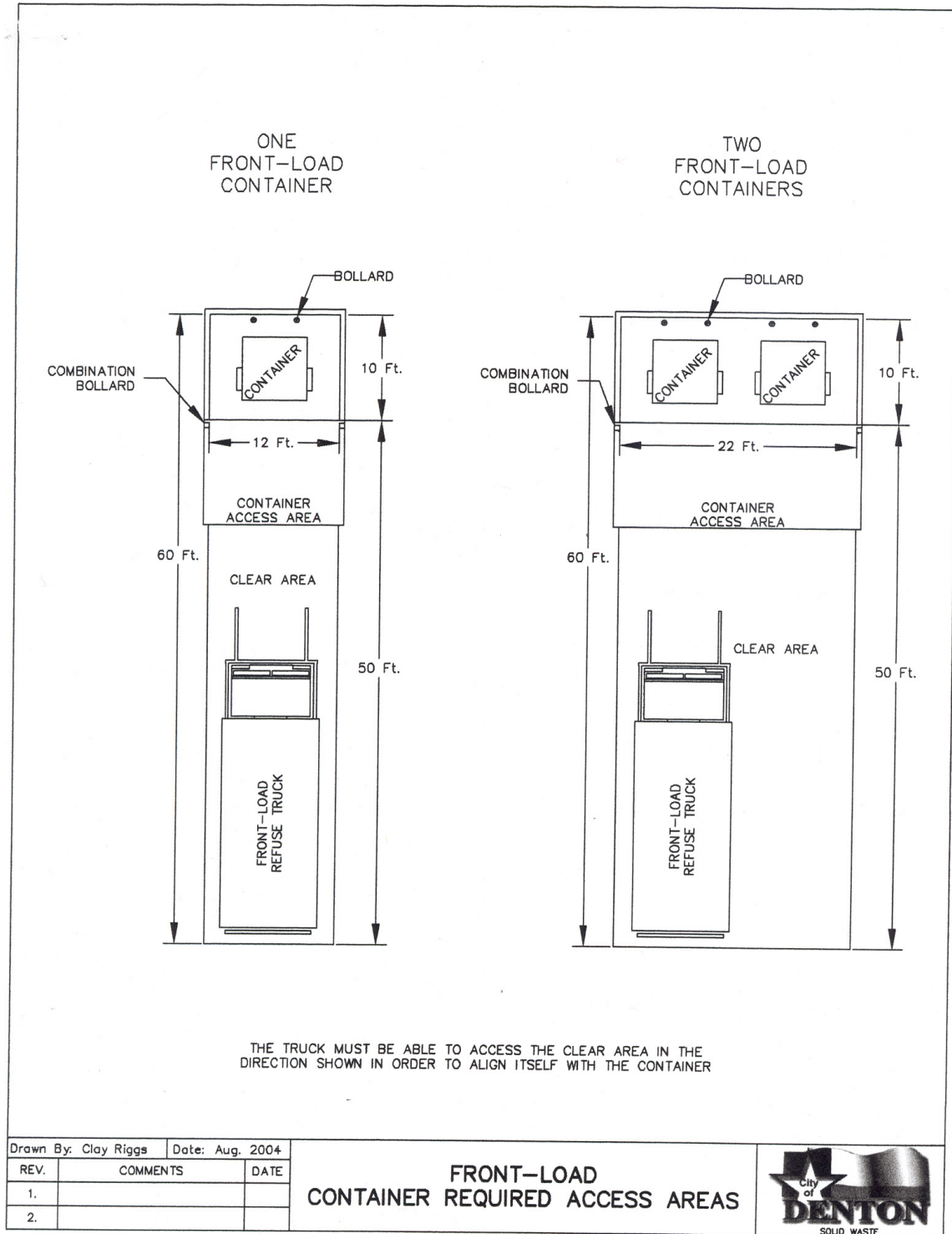

Figure 9 Outdoor Solid Waste Front-Load Containers Detail



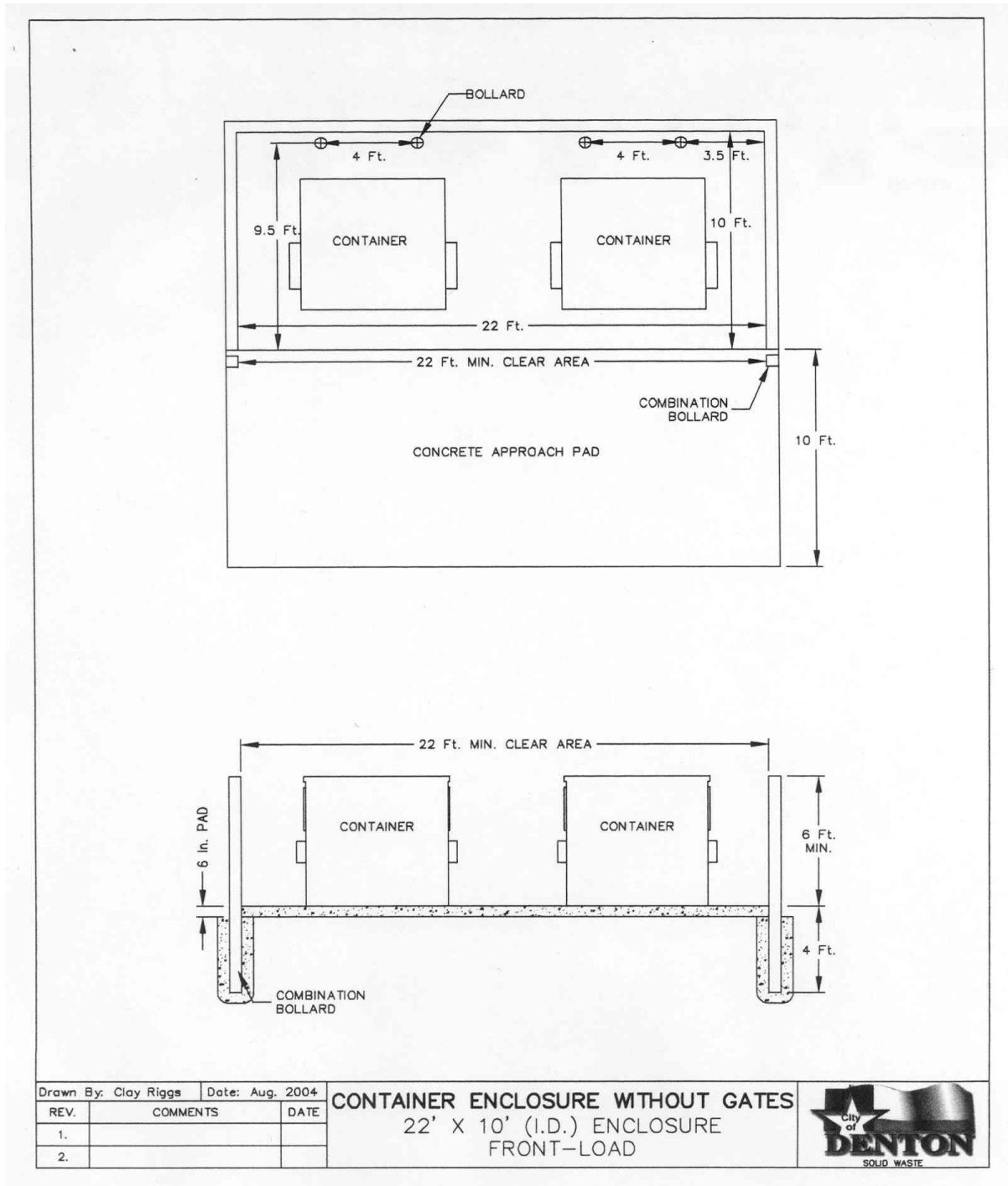

Figure 10 Outdoor Solid Waste Container Enclosure Without Gates Detail

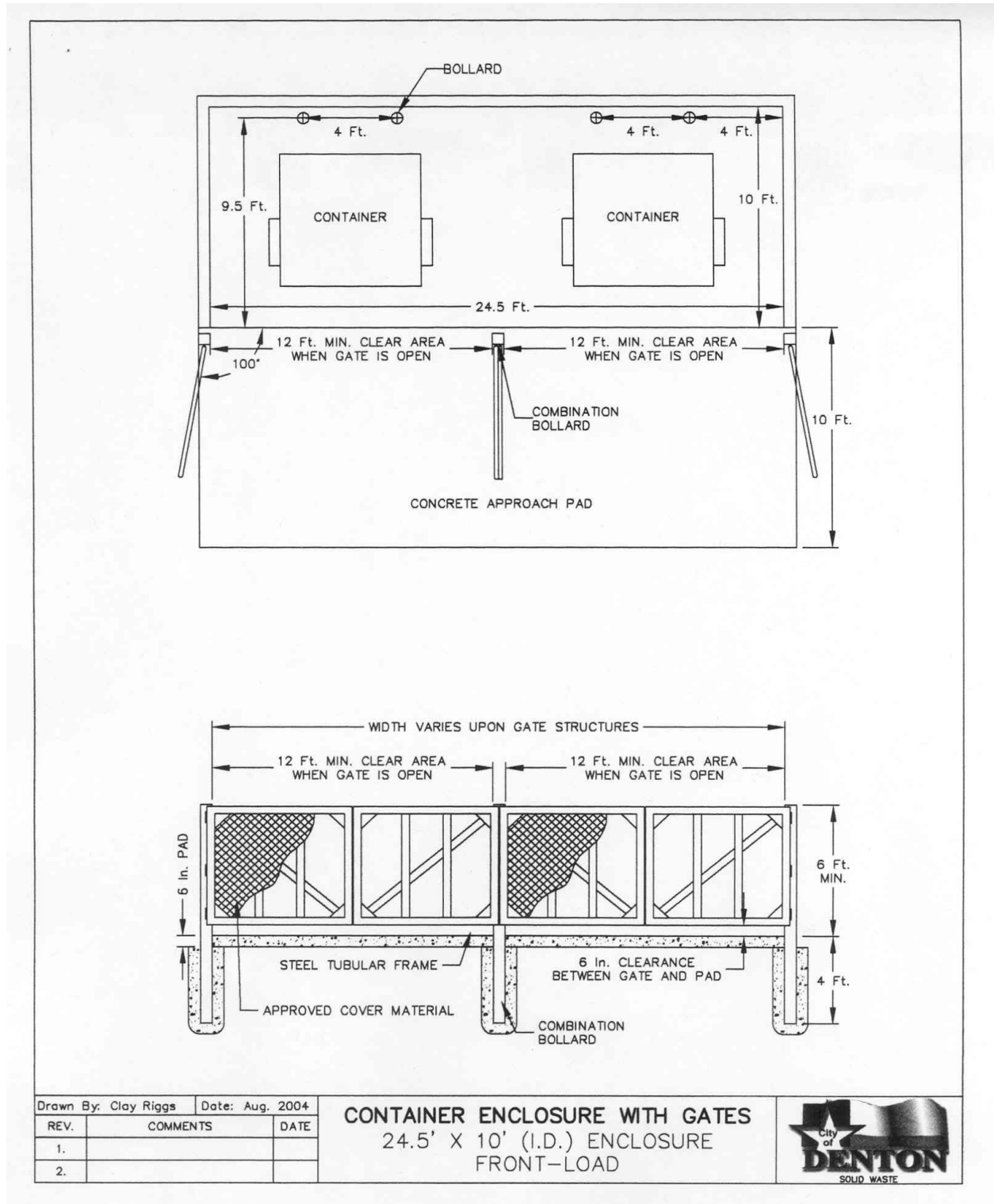
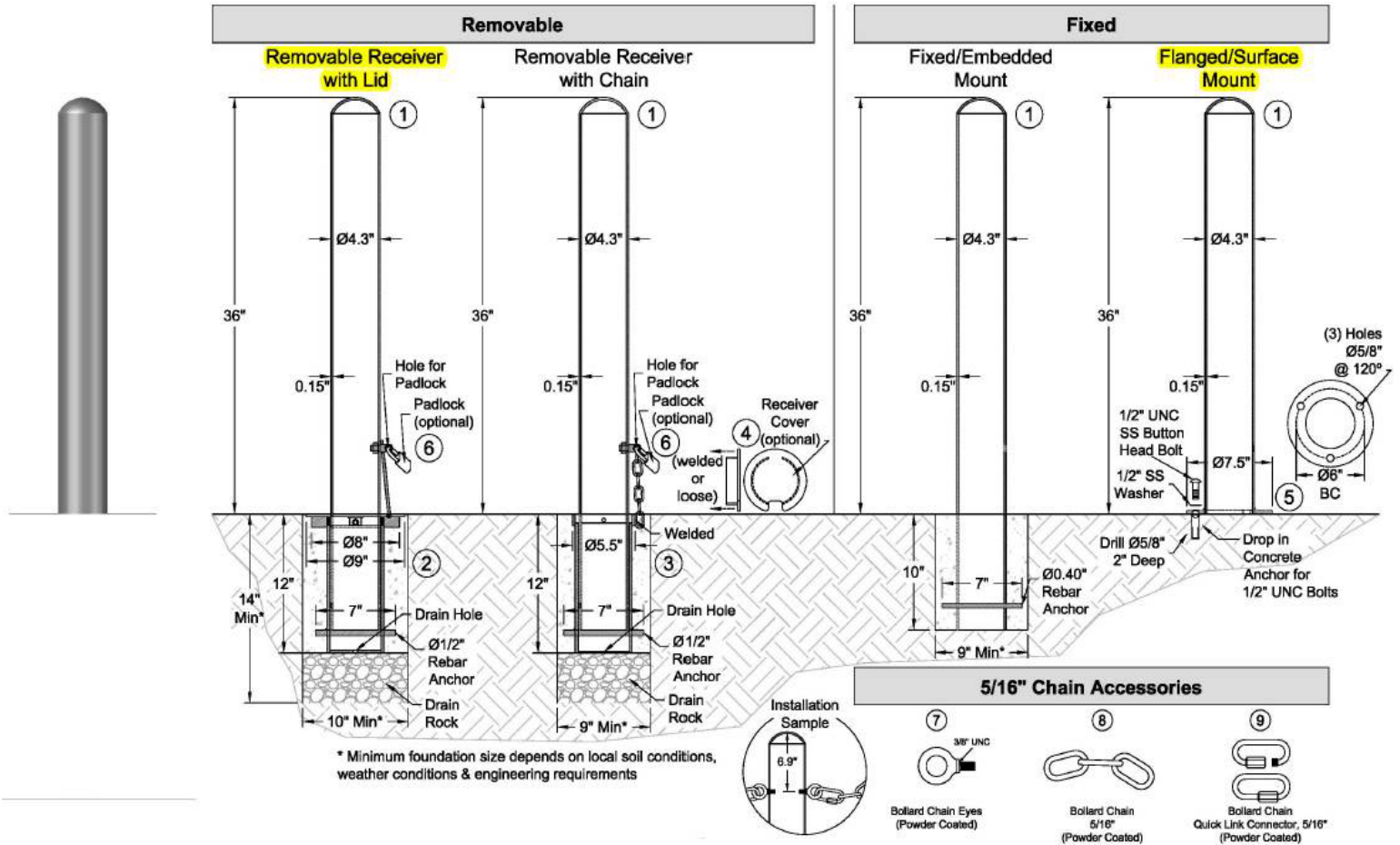

Figure 11 Outdoor Solid Waste Enclosure with Gates Detail



Bollard				
Item	Part Number	Description	Material	Weight
1	R-7902	Bollard Post	Steel (ASTM A36)	29 lbs.
1	R8902	Bollard Post	Stainless steel (SAE 316)	34 lbs.

Mount Options & Accessories			
Item	Part Number	Description	Material
2	R-7901-R	Removable Receiver with lid	Galvanized steel, c/w SAE 304 Stainless steel cover
2	R-8901-R	Removable Receiver with lid	Stainless Steel (SAE 316)
3	R-7900-R	Removable Receiver with chain	Galvanized steel, c/w SAE 304 stainless steel chain
3	R-8900-R	Removable Receiver with chain	Stainless Steel (SAE 316)
4	R-7900-C	Cover for removable receiver with chain (OPTIONAL)	Stainless Steel (SAE 316)
5	R-7900-F	Flanged/surface mount	Steel (ASTM A36)
5	R-8900-F	Flanged/surface mount	Stainless Steel (SAE 304)
6	Padlock 936	Padlock, marine grade (OPTIONAL)	Brass; chrome plated with stainless steel shackle
6	Padlock 835	Padlock (OPTIONAL)	Brass
7	R-7500-E	Chain Eye Loop	Steel - Forged
8	R-7500-CH	Chain, 5/16" (measure in feet)	Steel - Plated
9	R-7500-Q	Chain Quick Link, 5/16"	Steel - Plated

REV	DATE	DESCRIPTION	DR

**RELIANCE FOUNDRY**  
CO. LTD.

Unit 207, 6450 - 148 Street, Surrey, BC, Canada V3S-7G7  
1-888-735-5680 - info@reliance-foundry.com  
www.reliance-foundry.com | www.bollards.ca | www.bike-parking.ca

**Removable Bollard, Model R-7902 and R-8902**

SCALE	NTS	DRAWING NUMBER	SIZE	REV.
DESIGN	LC	<b>R-7902 / R-8902</b>	A	
DATE	12/19/2011			

Figure 12 Bollard Detail

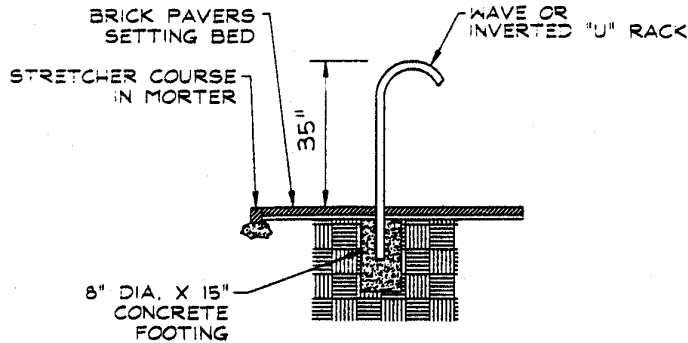

**ANCHOR TO SUBSURFACE**

**SPECIFICATIONS:**

**WAVE-SHAPED RACKS**

RACKS SHALL BE EQUAL OR SUPERIOR TO "WAVE LOK" AS MANUFACTURED BY SUNSHINE-U-LOK CORP. 31316 VIA COLINAS, SUITE 102, WESTLAKE VILLAGE, CA. 91382 (818) 707-0110

2" DIAMETER, MIN. SCHEDULE 10, 16 GAUGE STEEL PIPE WITH DIPPED AND BAKED BLACK POLYVINYL FINISH. 180 DEGREE BENDS IN A WAVE PATTERN TO PROVIDE FOUR VERTICAL POSTS A WIDTH OF 18" APART FROM CENTER TO CENTER. INSTALLED HEIGHT OF 35". ANCHOR TO SUBSURFACE.

**INVERTED "U" SHAPED RACKS:**

RACKS SHALL BE EQUAL OR SUPERIOR TO "WAVE-LOK" AS MANUFACTURED BY SUNSHINE-U-LOK CORP.

2" DIAMETER, MINIMUM SCHEDULE 10, 16 GAUGE STEEL PIPE WITH DIPPED AND BAKED BLACK POLYVINYL FINISH. 180 DEGREE BENDS IN A WAVE PATTERN TO PROVIDE TWO VERTICAL POST A WIDTH OF 18" APART. INSTALLED HEIGHT OF 35". ANCHOR TO SUBSURFACE.

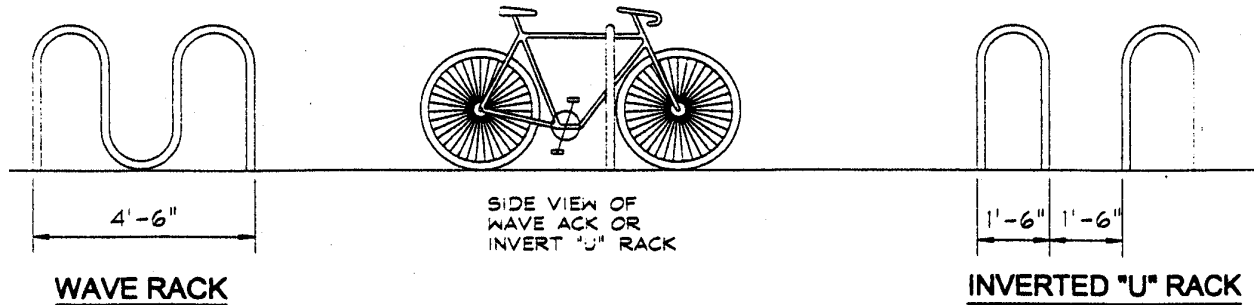

**BICYCLE RACKS**  
STANDARD DETAILS

*Figure 13 Bicycle Racks Detail*

*See section 32 33 13 exterior improvements bike racks for alternative product option*

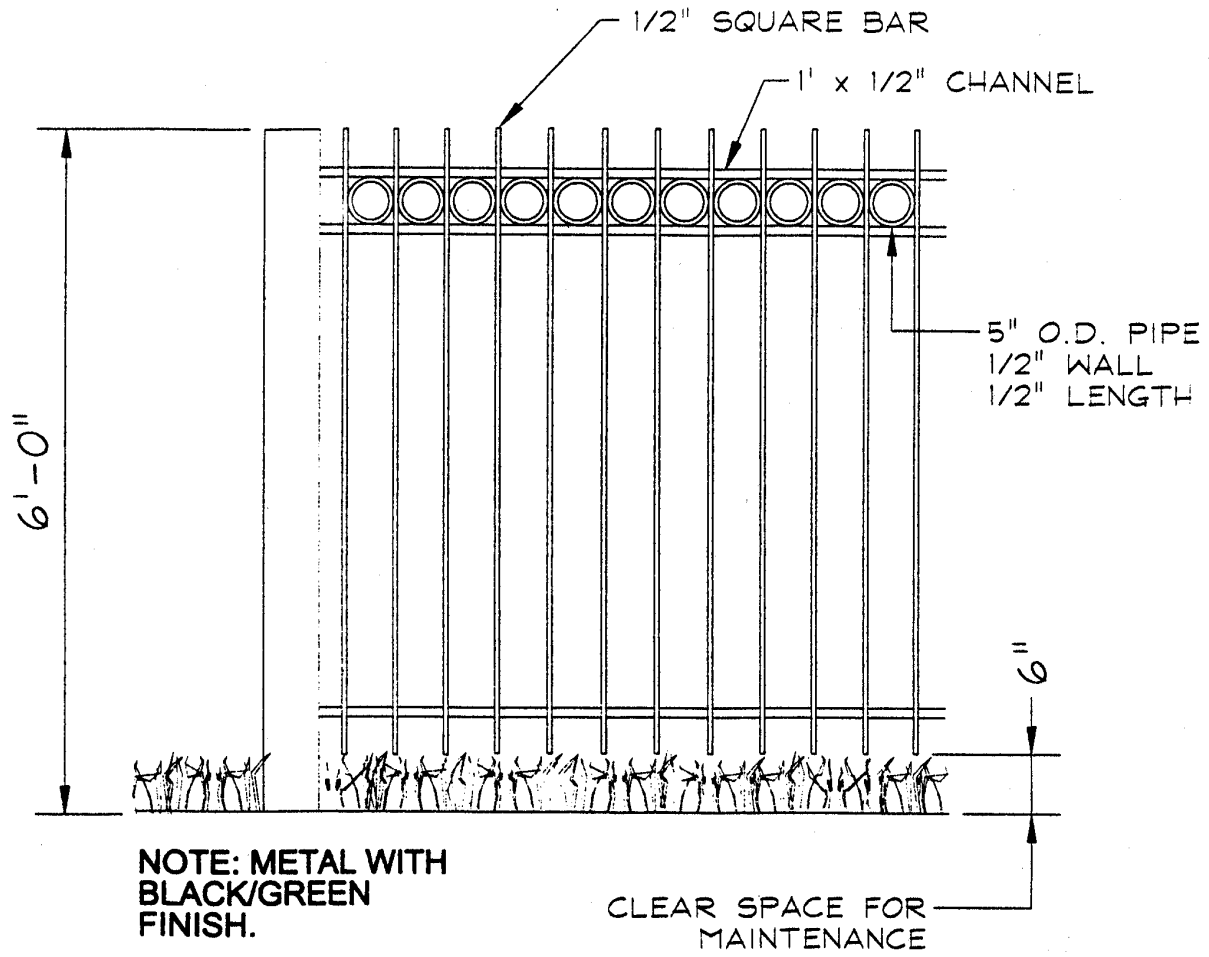

## FENCES

---

### STANDARD DETAILS

*Figure 14 Fence Detail*

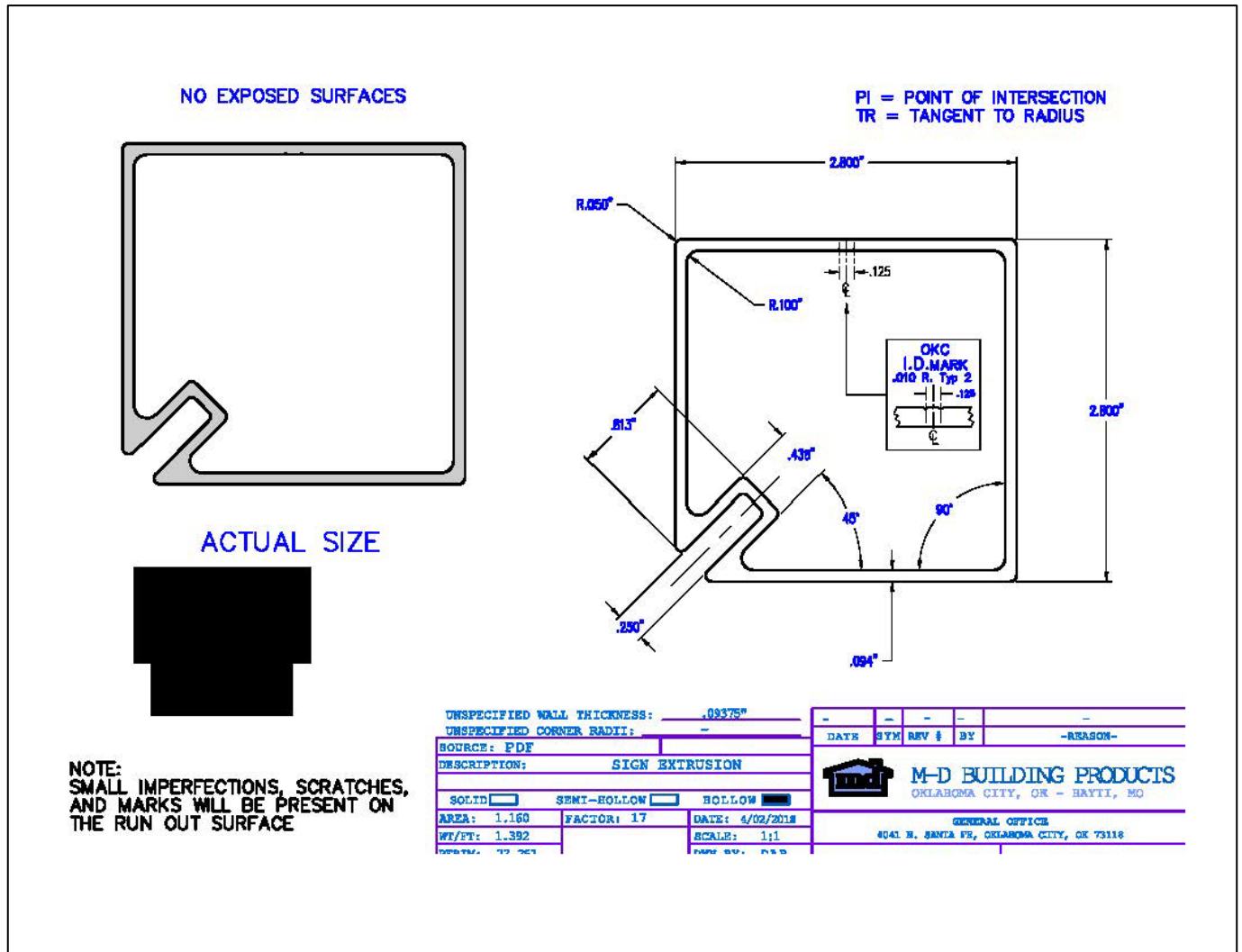

Figure 15 Building and Parking Lot Sign Post Specification

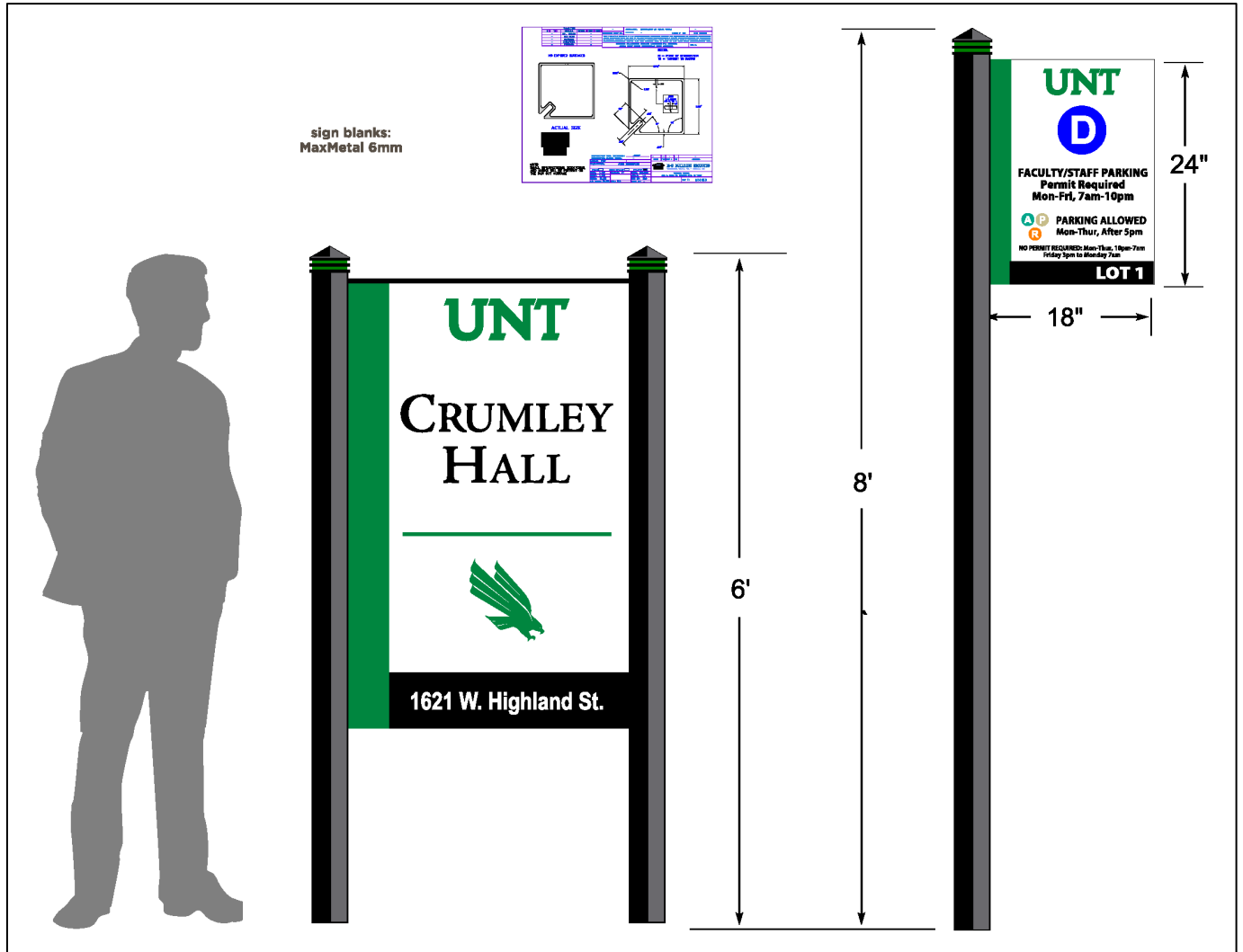

Figure 16 Building and Parking Lot Entry Sign Detail

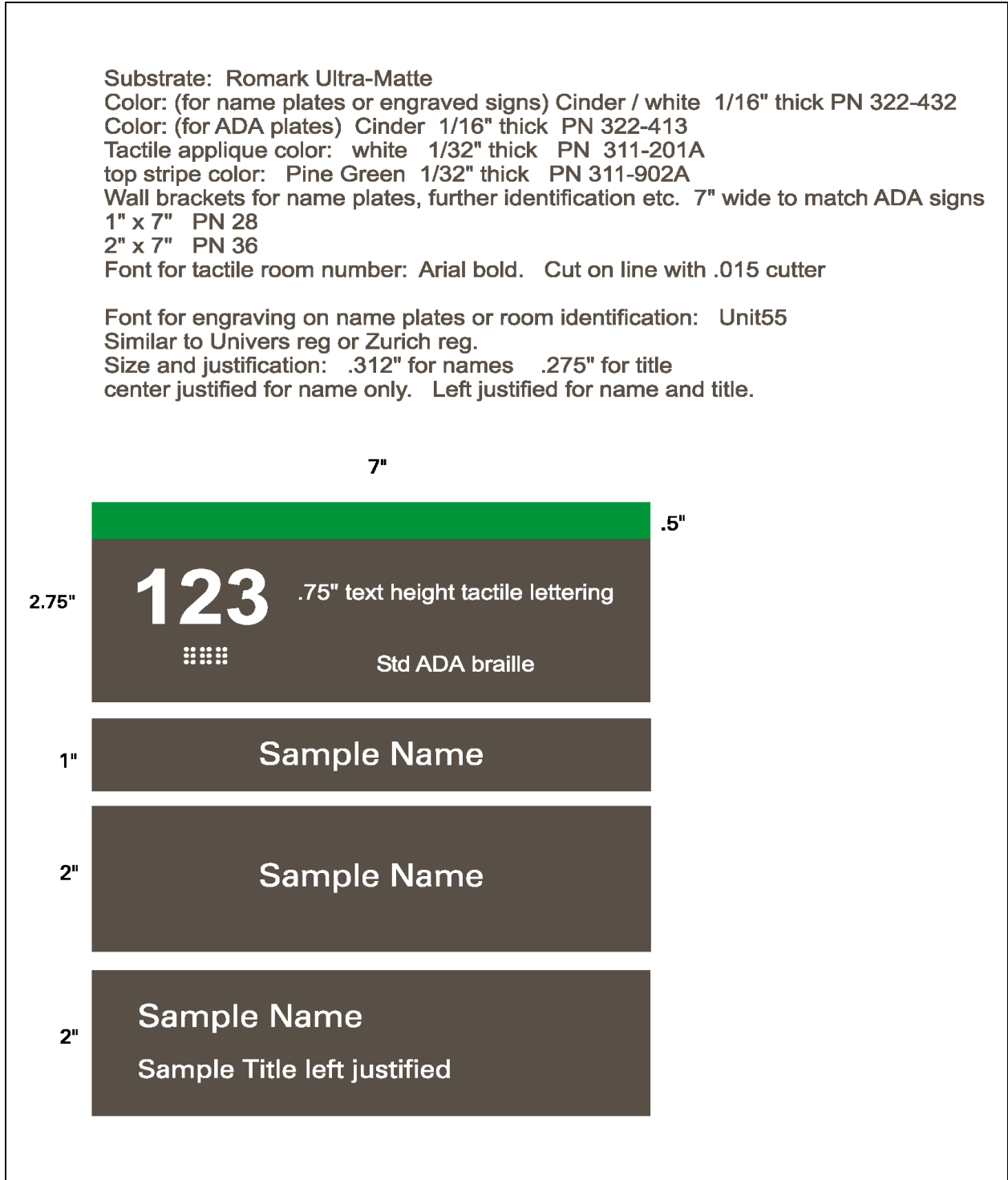
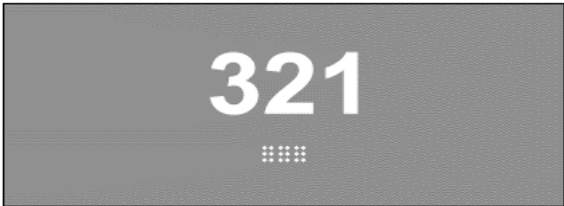



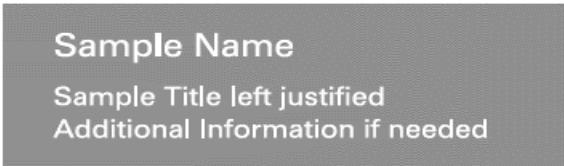

Figure 17 Interior Signage Plate Details Option 1  
Renovation to match adjacent



6"		
2.5"		<p>Std Room ID (number only) 2.5" x 6" Tactile number .75" tall Std Braille under tactile number Arial Bold - engrave on line with .015</p>
3.5"		<p>Std Room ID with room name 3.5" x 6" Tactile number .75" tall Std Braille under tactile number Arial Bold - engrave on line with .015 Room name: Univers55 .3125"</p>
1"		<p>Std name plate (name only) centered 1" x 6" Univers55 .3125"</p>
1"		<p>Std name plate (with title) left justified 1" x 6" Univers55 Name: .285" Title: .225"</p>
2"		<p>Std name plate (with title) left justified 2" x 6" Univers55 Name: .285" Title: .225"</p>
		<p>Nameplates mounted in wall brackets Install directly under Room ID - no space</p>

Substrate: Romark  
 Color: Gray/White 1/16" thick PN 222-312  
 Tactile applique color: white 1/32" thick PN 311201A  
 Wall brackets for name plates, further identification etc. 6" wide to match ADA signs  
 1" x 6" JRS PN 28  
 2" x 6" JRS PN 36

Font for tactile room number: Arial bold. Cut on line with .015 cutter

Font for engraving on name plates or room identification: Unit55  
 Similar to Univers reg or Zurich reg.

*Figure 18 Interior Signage Plate Details Option 2  
 New build or renovation to match adjacent*

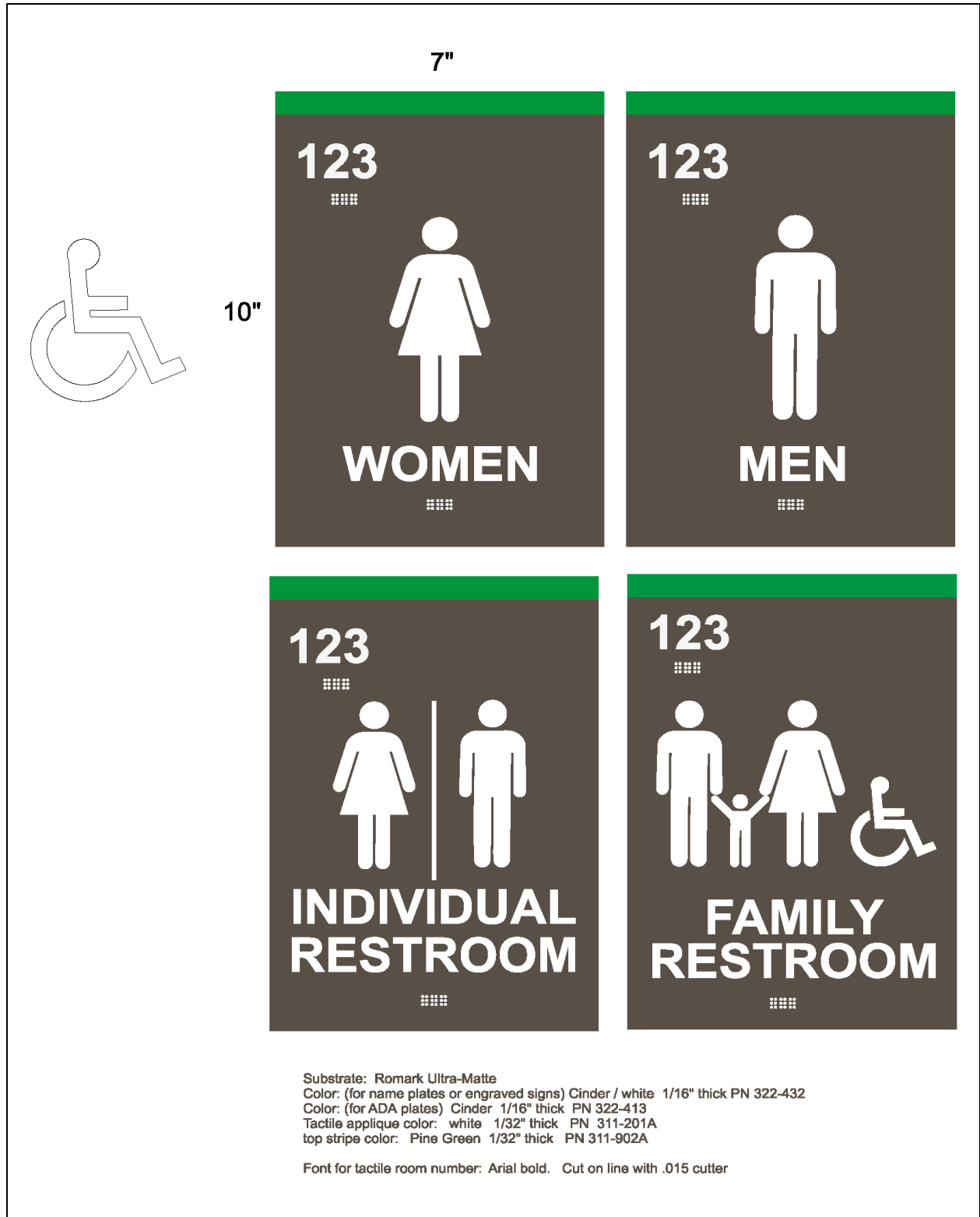
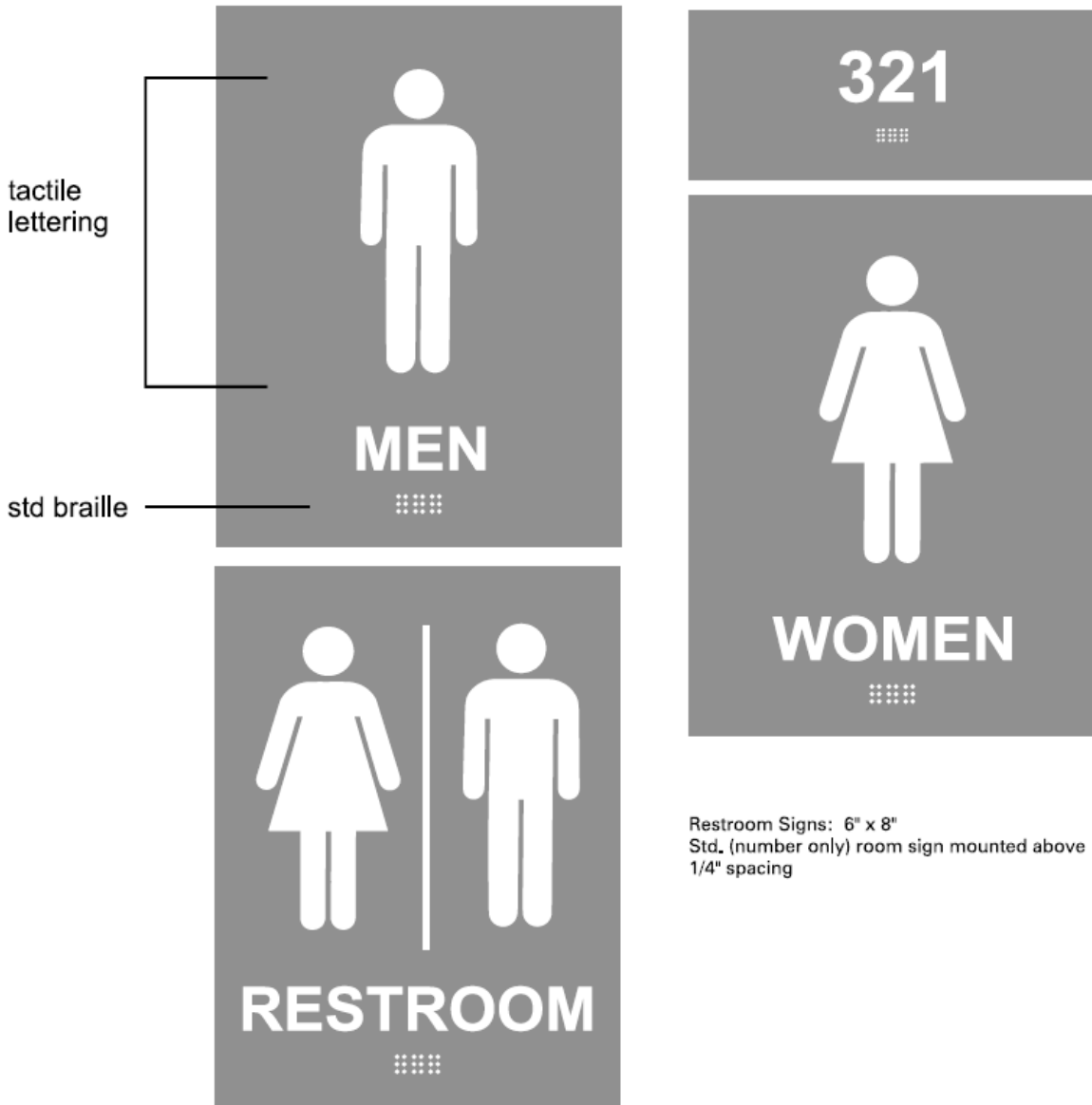

Figure 19 Restroom Signage Option 1  
Renovation to match adjacent



Substrate: Romark  
 Color: Gray/White 1/16" thick PN 222-312  
 Tactile applique color: white 1/32" thick PN 311201A  
 Wall brackets for name plates, further identification etc. 6" wide to match ADA signs  
 1" x 6" JRS PN 28  
 2" x 6" JRS PN 36

Font for tactile room number: Arial bold. Cut on line with .015 cutter

Font for engraving on name plates or room identification: Unit55  
 Similar to Univers reg or Zurich reg.

*Figure 20 Restroom Signage Option 2  
 New build or Renovation to match adjacent*

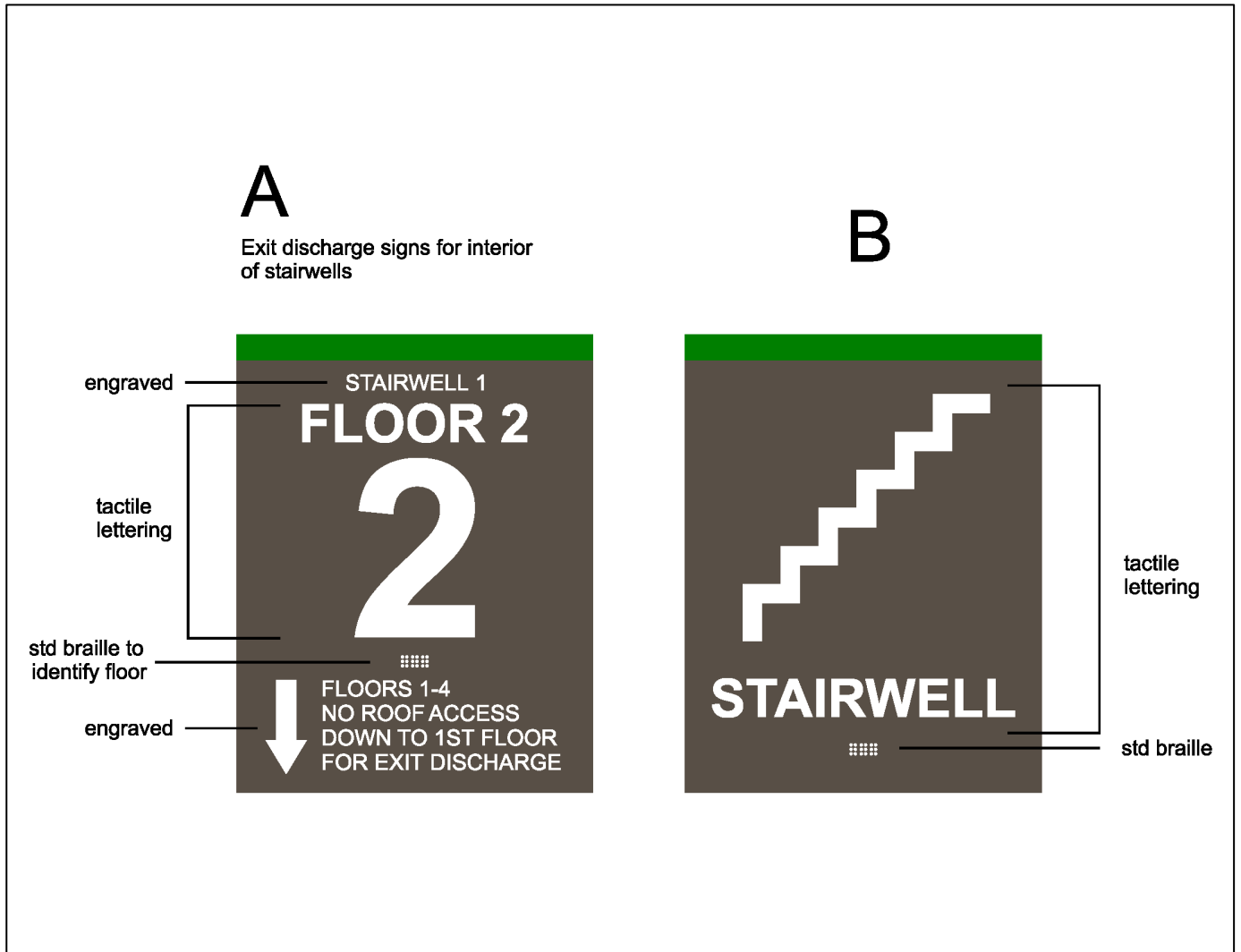
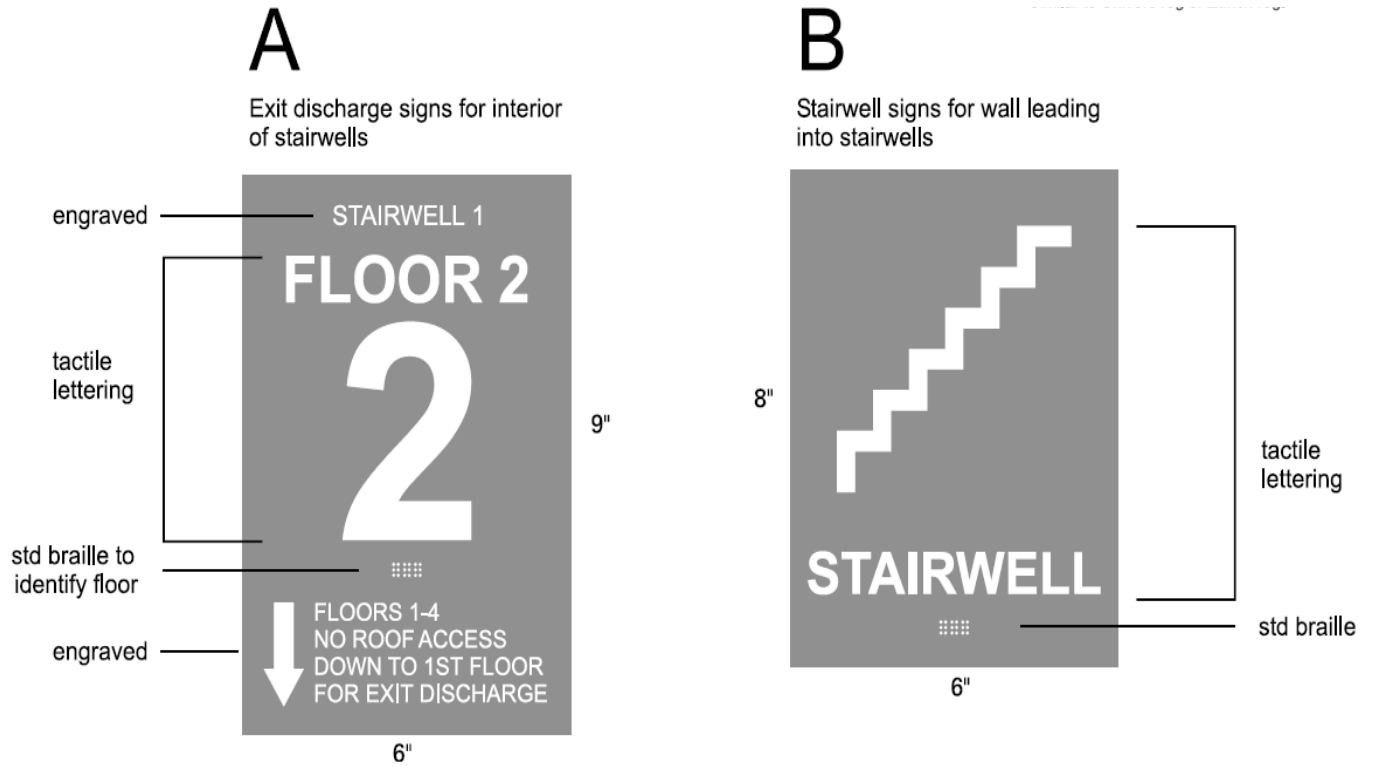
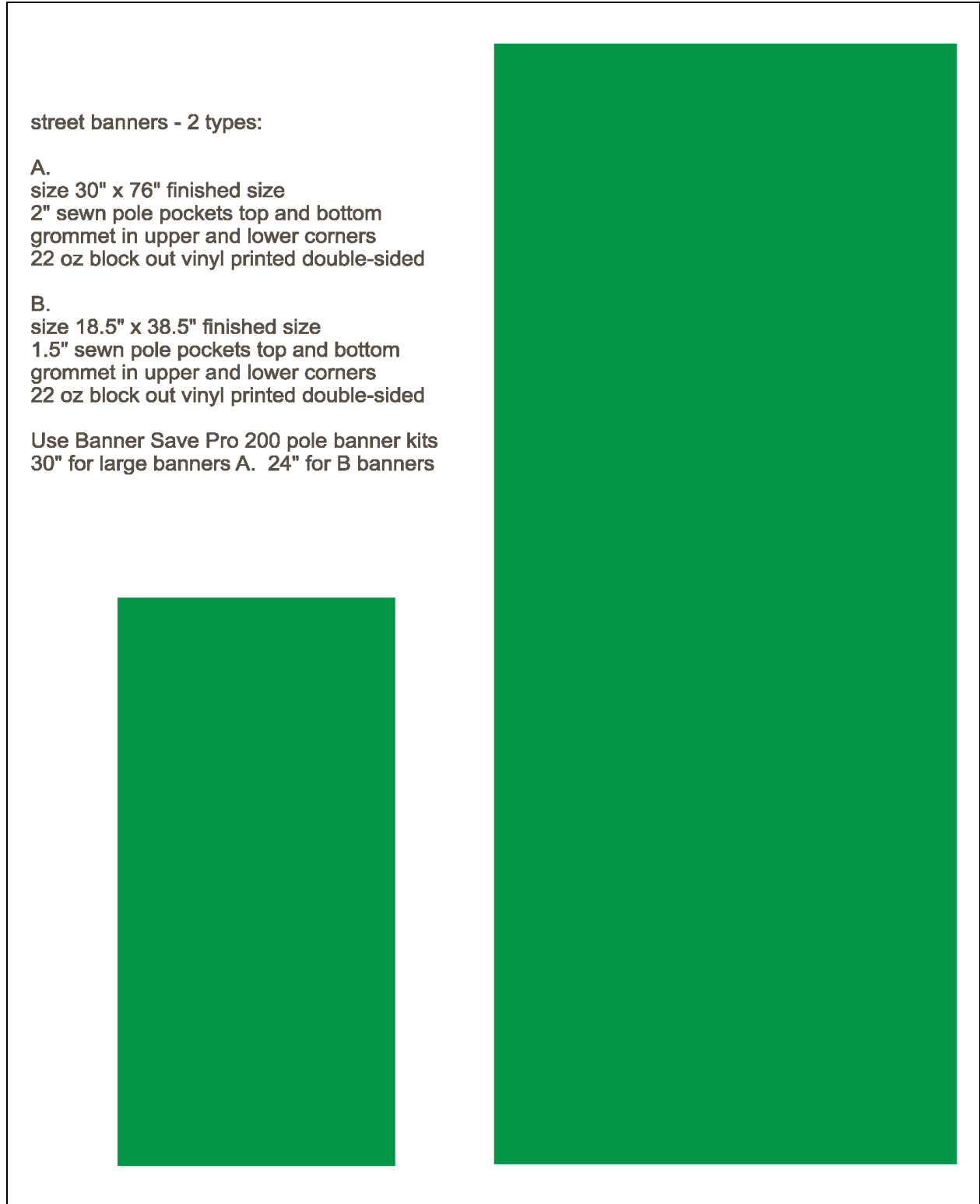

Figure 21 Stairwell and Exit Signage Detail Option 1  
Renovation to match existing



*Figure 22 Stairwell and Exit Signage Detail Option 2  
New buildings and Renovation to match existing*



*Figure 23 Street Banner Details*

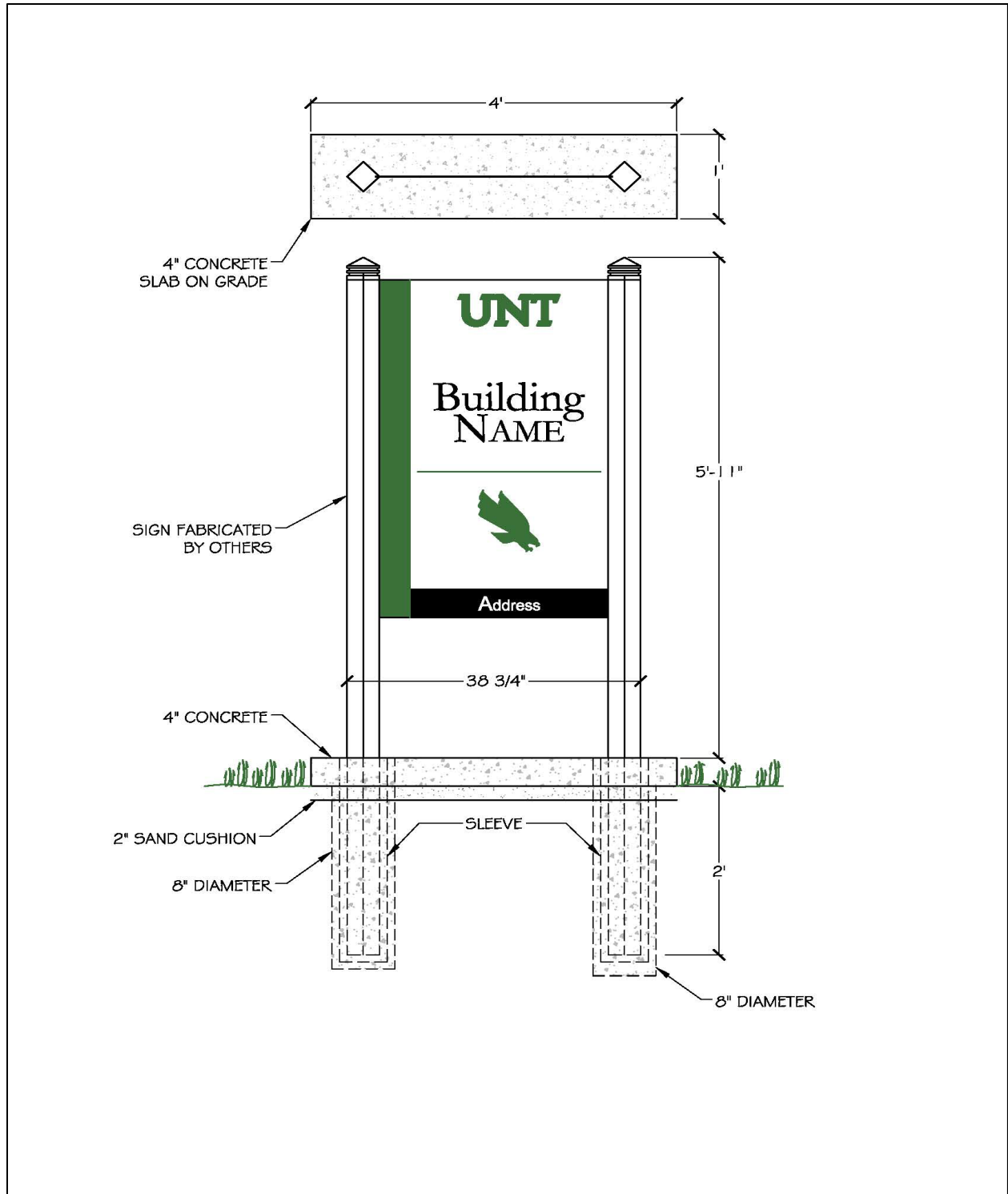

Figure 24 Building Sign Installation Detail



**Code Blue®**

**CB I-s**



**PEDESTAL - INTERACTIVE VOICE COMMUNICATION UNIT**

The **CB I-s** is the original Code Blue Pedestal unit and sets the industry standard for rugged construction, full feature availability and high visibility. The **CB I-s** is easily recognized throughout a full 360-degree area. The user friendly lighted faceplate and the integral area light ensures rapid location in an open environment. The high powered strobe is easily identifiable by security when activated. The exclusive CB 3100 speakerphone is designed for maximum reliability and leads the market in system programming flexibility. The **CB I-s** is an excellent choice for walkways, parks, college and commercial campus areas, open landscape areas and anywhere a freestanding pedestal unit is required.

**STANDARD FEATURES:**

- CB 3100 Speakerphone
- 3 auxiliary inputs
- 2 auxiliary outputs
- Phone line surge suppressor
- Analog telephone connection
- 70w HPS area light with Code Blue Beacon
- High powerd strobe
- Lighted stainless steel faceplate
- 120v AC power
- Ultra weather resistant finish
- Vandal resistant hardware
- UV resistant lenses
- 12.75" diameter/ 9'1½" height
- ¼" thick steel construction
- Overhead Camera Mount
- Internal foundation anchor kit
- Passive vent
- ADA compliant

**OPTIONAL FEATURES:**

- |  |  |
|--|--|
| <input type="checkbox"/> Two button speakerphone             | <input type="checkbox"/> Photocell for area light    |
| <input type="checkbox"/> Two button speakerphone with keypad | <input type="checkbox"/> Powered vent                |
| <input type="checkbox"/> 2.4 Ghz RF communication            | <input type="checkbox"/> Step-down power transformer |
| <input type="checkbox"/> Cellular communication              | <input type="checkbox"/> Custom colors               |
| <input type="checkbox"/> Night Charge™                       | <input type="checkbox"/> Custom graphics             |
| <input type="checkbox"/> 70 watt metal halide area light     |  |

Code Blue Corp. - 92 East 64<sup>th</sup> Street - Holland, MI 49423 - 800-205-7186 - Fax 616-392-8391 - www.codeblue.com

Figure 25 Emergency Phone Specification 1





**CB I-s**

**STANDARD FINISH COLORS**

Safety Blue	Gloss Black
Safety Red	Medium Bronze
Safety Yellow	Dark Bronze
Midnight Blue	Cardinal Red
Gloss White	British Racing Green

**GRAPHICS TEXT (WORDING)**

Emergency Assistance	Courtesy Security
----------------------	-------------------

**GRAPHICS COLOR**

Reflective White	Reflective Black
Reflective Blue	Reflective Red

Custom colors and graphics from RAL number or sample are available as a special order.

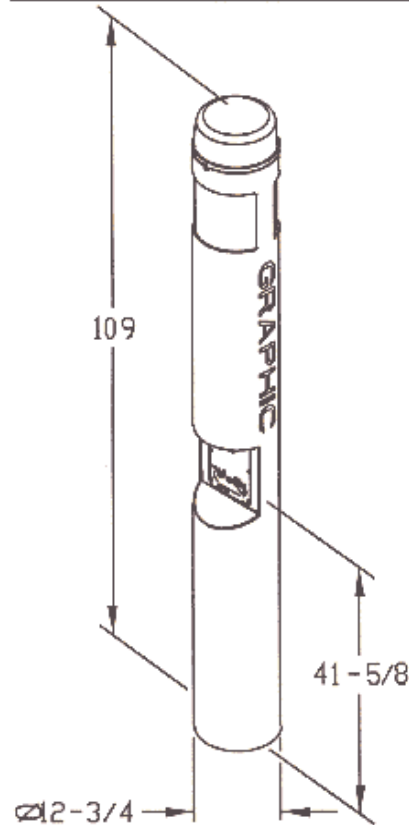

Code Blue Corp. - 92 East 64<sup>th</sup> Street - Holland, MI 49423 - 800-205-7186 - Fax 616-392-8391 - www.codeblue.com

**FACEPLATE OPTIONS**

FP 1	FP 2	FP 2-K
Standard Faceplate Assembly with Single red <i>Push For Help</i> button	Optional Faceplate Assembly with additional black <i>Info</i> button	Optional Faceplate Assembly with additional <i>Call</i> button and keypad

**CELLULAR OPTION**

Provides wireless communications to eliminate trenching for phone lines. System requires a reliable AMPS cellular service to be provided by customer.

**NIGHT CHARGE™ OPTION**

Provides continuous power to the Code Blue unit from a non-continuous power source. Typically used with an outdoor lighting network when power is only on during a portion of the day or night.

**CODE BLUE UNIT SPECIFICATIONS**

Overall Height	9' 1"
Outside Diameter	12 3/4"
Housing Material	1/4 inch steel
Overall Weight	375 pounds
Access Opening	8 1/2" x 12"
Standard Power Requirements	120v AC

Mounting hardware and template for each CB I-s is shipped in advance of unit for foundation work.

Figure 26 Emergency Phone Specification 2

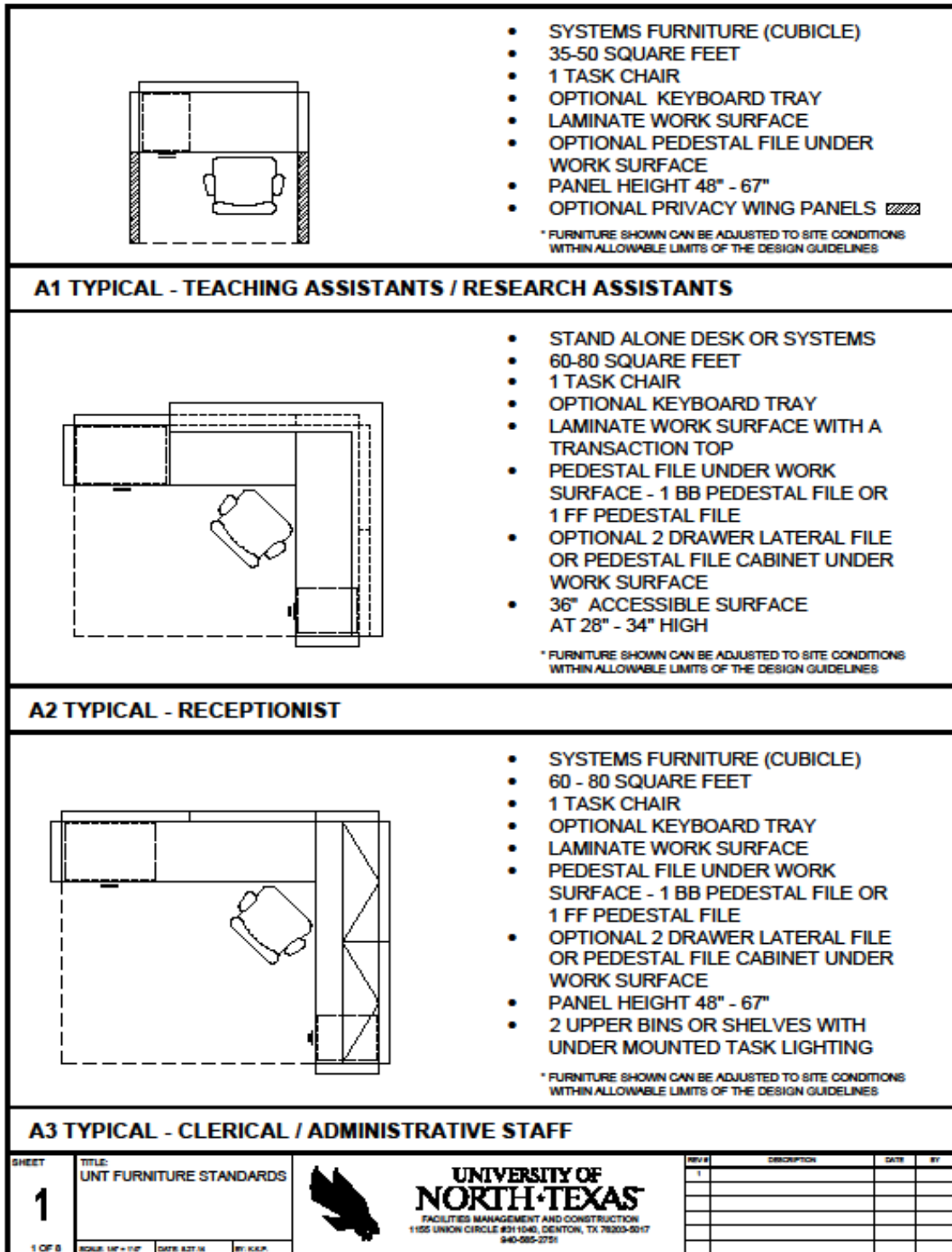
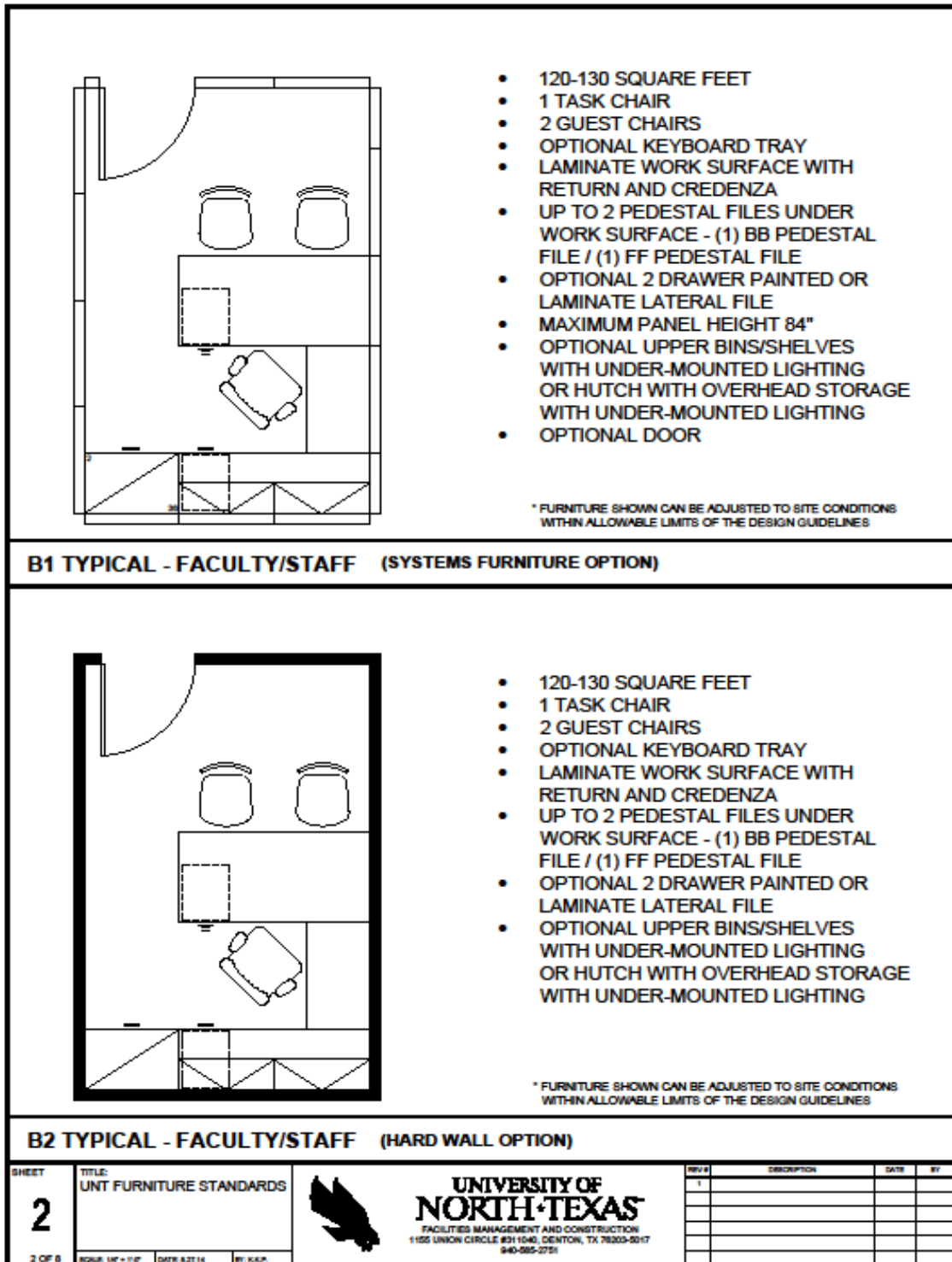
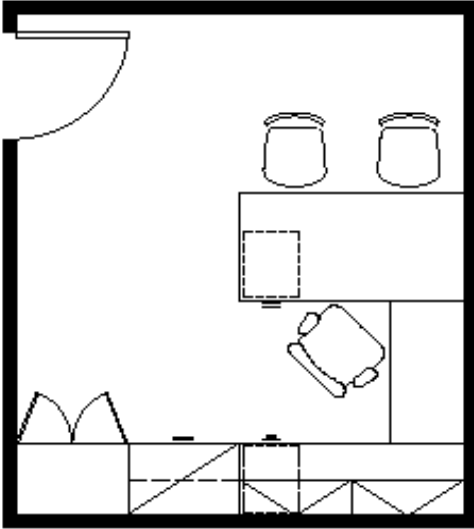

Figure 27 Office Standards: Typical A





**C1 TYPICAL - DEPARTMENT CHAIR, DIRECTOR OR EQUIVALENT**

- HARDWALL OFFICE
- 140 - 150 SQUARE FEET
- 1 TASK CHAIR
- 2 GUEST CHAIRS
- OPTIONAL KEYBOARD TRAY
- LAMINATE OR VENEER DESK WITH RETURN AND CREDENZA
- 1 BB PEDESTAL FILE AND 1 FF PEDESTAL FILE UNDER WORK SURFACE
- 2 DRAWER LAMINATE OR VENEER LATERAL FILE CABINET
- UPPER BINS OR SHELVES WITH UNDER-MOUNTED LIGHTING OR OPTIONAL HUTCH WITH OVERHEAD STORAGE AND UNDER-MOUNTED LIGHTING
- OPTIONAL STORAGE PIECE IN LAMINATE OR VENEER - SEE PAGE 6 FOR STORAGE COMPONENTS

\* FURNITURE SHOWN CAN BE ADJUSTED TO SITE CONDITIONS WITHIN ALLOWABLE LIMITS OF THE DESIGN GUIDELINES

SHEET	TITLE	 <b>UNIVERSITY OF NORTH TEXAS</b> <small>FACILITIES MANAGEMENT AND CONSTRUCTION                      1155 UNION CIRCLE #311540, DENTON, TX 76203-5017                      940-585-3751</small>	REV.#	DESCRIPTION	DATE	BY
<b>3</b>	UNT FURNITURE STANDARDS		1			

3 OF 8    SCALE: 1/4" = 1'-0"    DATE: 8.27.14    BY: KAK

Figure 29 Office Standards: Typical C1

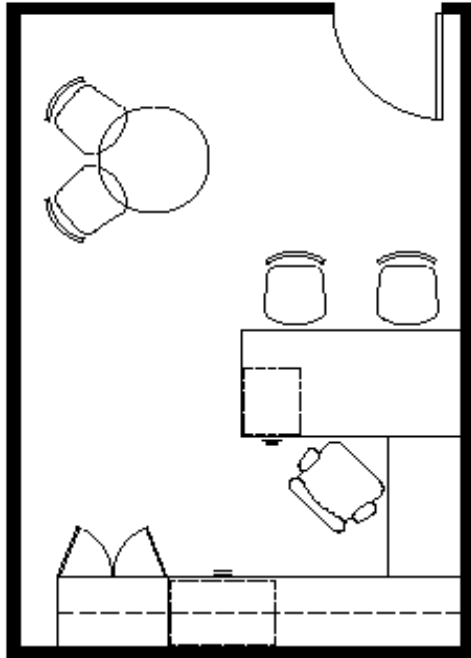

**C2 TYPICAL - ASSOCIATE DEAN OR EQUIVALENT**

- HARDWALL OFFICE
- 150 - 160 SQUARE FEET
- 1 TASK CHAIR
- 2 GUEST CHAIRS
- 2 CONFERENCE CHAIRS
- OPTIONAL KEYBOARD TRAY
- LAMINATE OR VENEER DESK WITH RETURN AND CREDENZA
- 1 BB PEDESTAL FILE UNDER WORK SURFACE
- 2 DRAWER LAMINATE OR VENEER LATERAL FILE CABINET UNDER WORK SURFACE
- HUTCH WITH STORAGE AND UNDER-MOUNTED LIGHTING
- OPTIONAL STORAGE PIECE IN LAMINATE OR VENEER - SEE PAGE 6 FOR STORAGE COMPONENTS
- 36" - 48" SMALL CONFERENCE TABLE

\* FURNITURE SHOWN CAN BE ADJUSTED TO SITE CONDITIONS WITHIN ALLOWABLE LIMITS OF THE DESIGN GUIDELINES

SHEET	TITLE: UNT FURNITURE STANDARDS	 <b>UNIVERSITY OF NORTH TEXAS</b> <small>FACILITIES MANAGEMENT AND CONSTRUCTION 1155 UNION CIRCLE #311040, DENTON, TX 76203-5017 940-895-2751</small>	REV #	DESCRIPTION	DATE	BY
<b>4</b>	4 OF 8    SCALE: 1/4" = 1'-0"    DATE: 8/27/14    BY: K.K.P.		1			

Figure 30 Office Standards: Typical C2

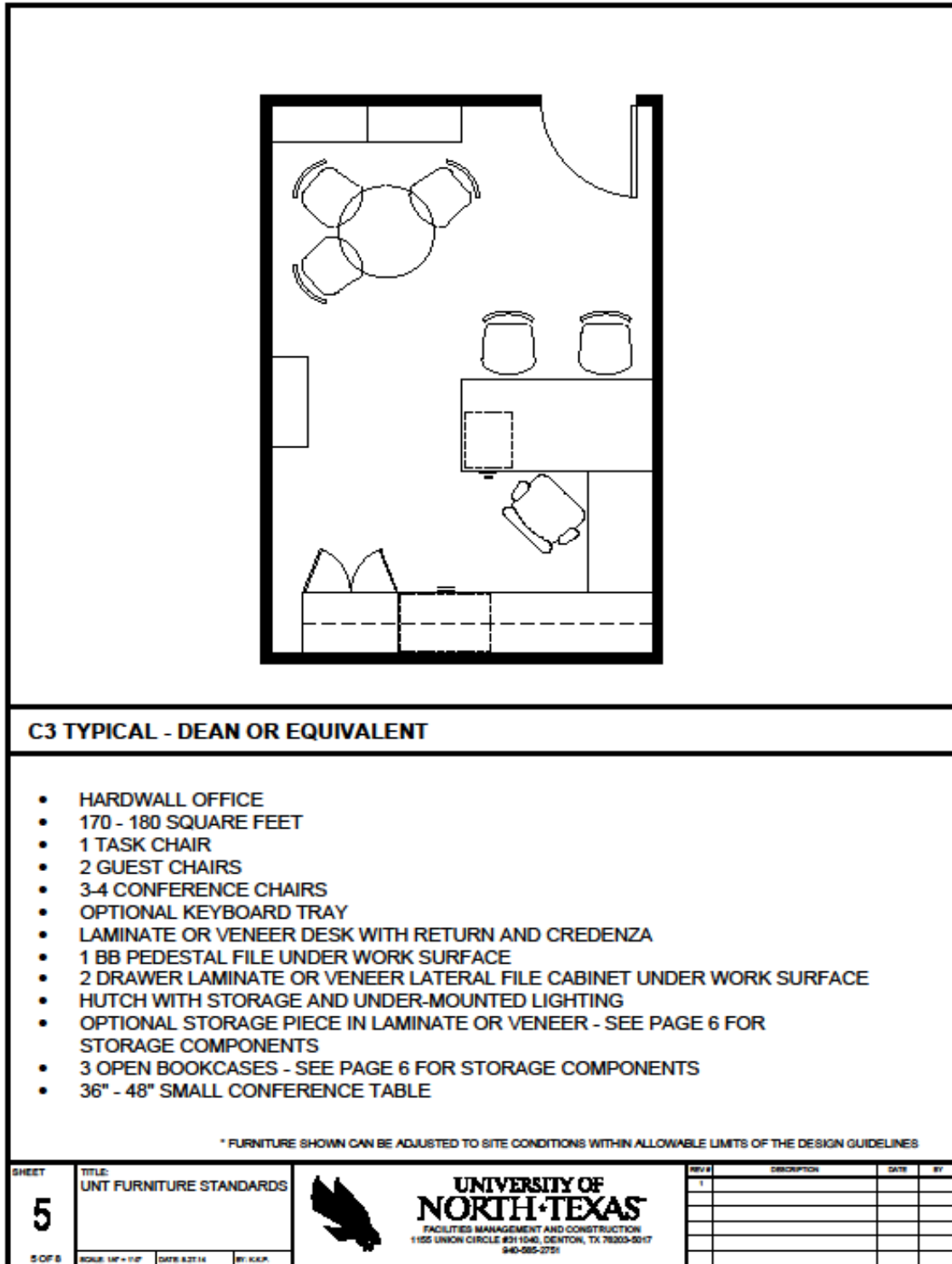

Figure 31 Office Standards: Typical C3

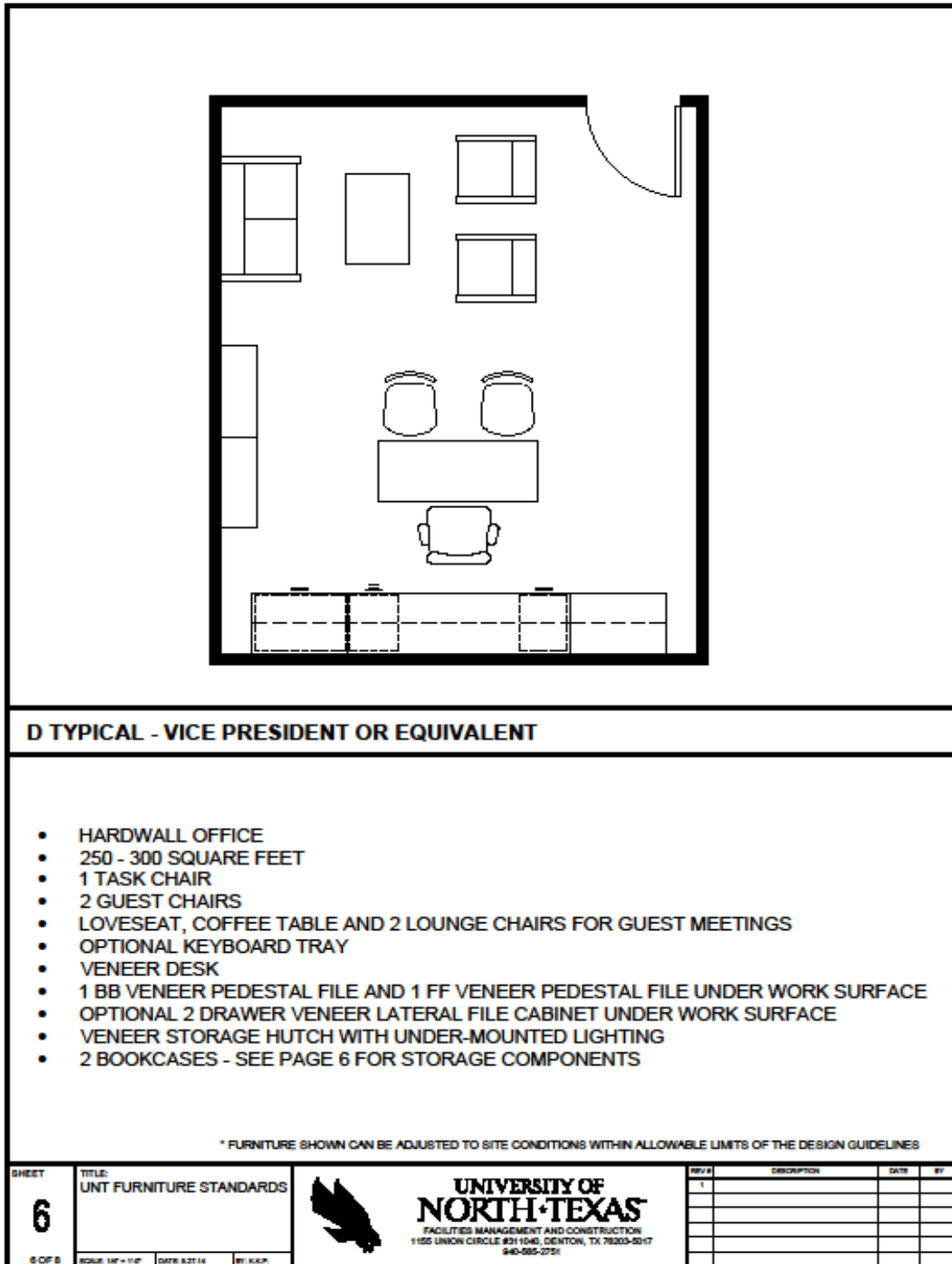

Figure 32 Office Standards: Typical D

# UNIVERSITY of NORTH TEXAS

## POLICY STATEMENT ELEVATOR SHUNT-TRIP DEVICES

Current State Elevator Laws require a shunt-trip shut-off device to kill power to elevators when water flow is detected in the fire sprinklers located in the elevator machine room or top of shaft. This loss of power greatly increases the risk that citizens and firefighters may become trapped in such elevators. The Fire Department uses elevators during fire situations for rescue, evacuation, and to transport fire fighting equipment and personnel to staging floor areas.

The Board of Regents for the University of North Texas System, has appointed the University System Architect as the Building Official, and Authority Having Jurisdiction for the University System as defined by all applicable codes.

Upon the recommendation of the UNT Fire Marshal, the University System Architect has ruled that such shunt-trip devices are not permitted in University of North Texas facilities. In the past, the Uniform Fire Code has allowed fire sprinkler heads to be omitted from the elevator machine rooms and top of the elevator shafts, with the concurrence of the Fire Chief, or other authority having jurisdiction. This eliminates the need or requirement for a shunt-trip device by the state elevator inspectors. Please note that supervised smoke detectors tied to the building fire alarm system are required in these areas. If you have any questions, please contact the Fire Marshal at 940-565-2109 or the University System Architect at 940-369-7000.

Recommended By:

  
Wendell McCloud  
University Fire Marshal

7/15/02  
Date

Approved By:

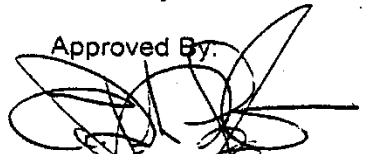
  
A. Peter Gignola, AIA, NCARB  
University System Architect

7.16.02  
Date

*Figure 33 Elevator Shunt-Trip Device Policy Statement*



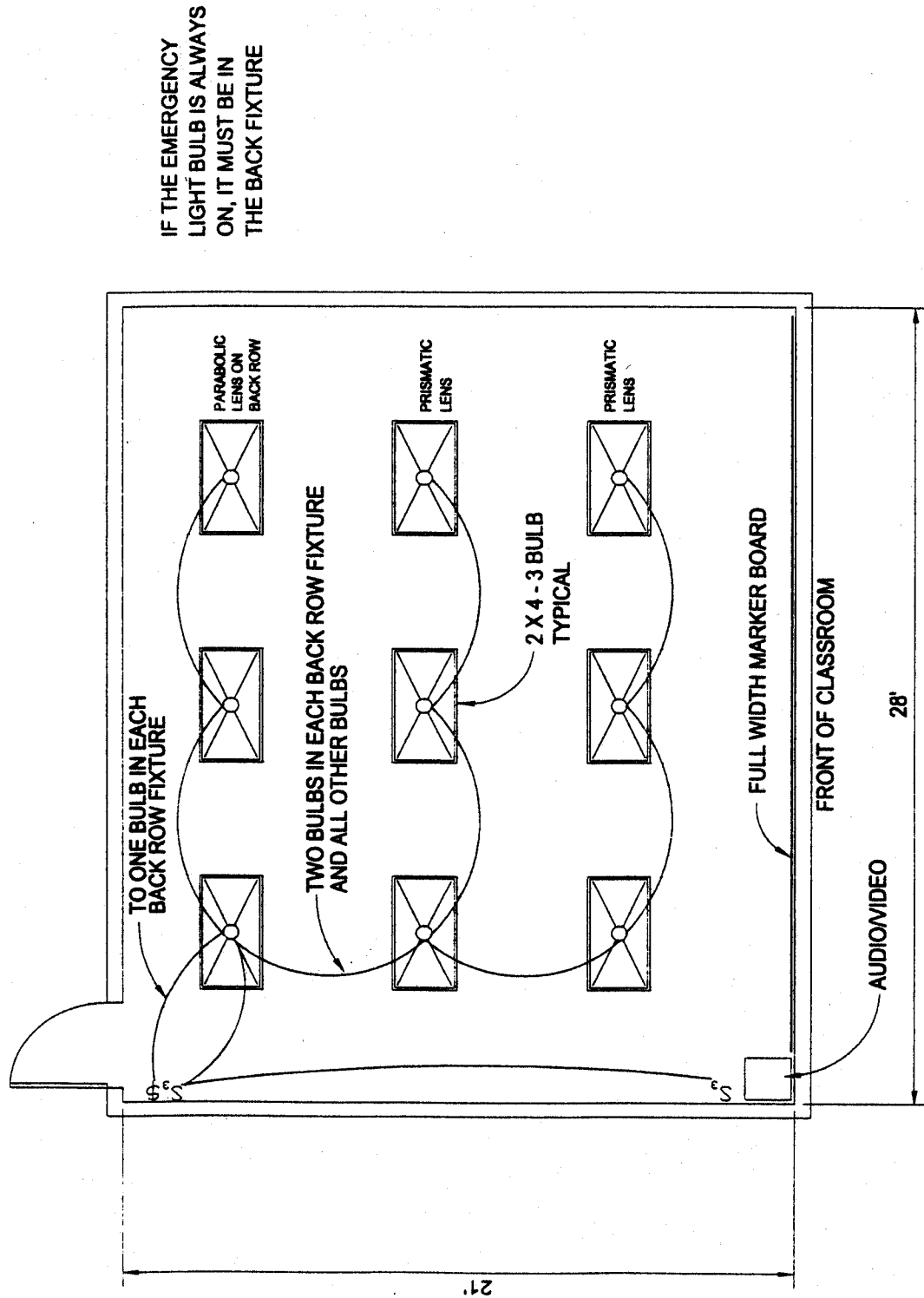
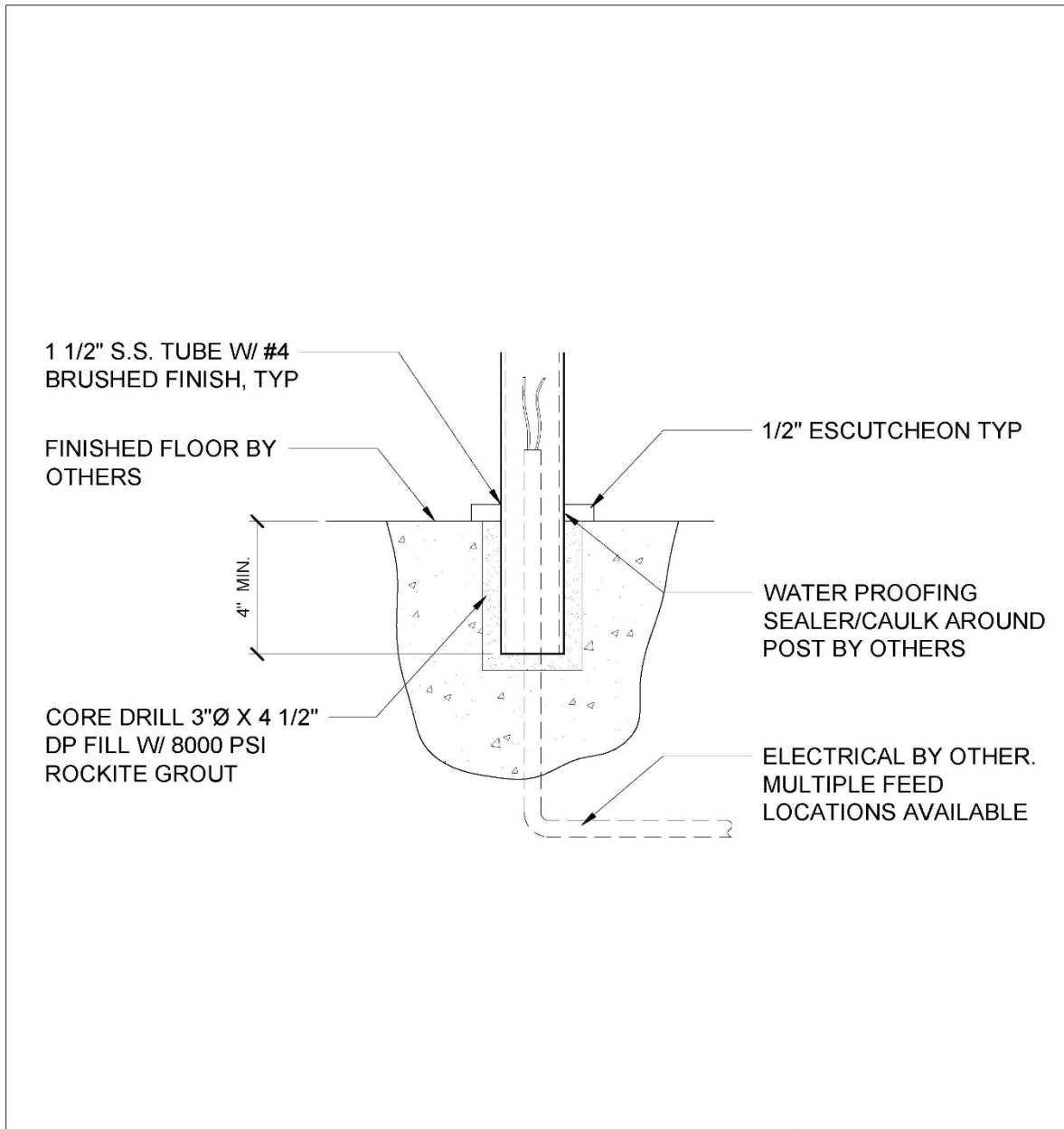

Figure 34 Classroom Lighting Detail

TYPICAL CLASSROOM LIGHTING - CAPACITY 36



*Figure 35 Electrical Box Mounting Bracket Example*



Mount Railing Detail

Scale: 3" = 1'-0"

Except where it may be otherwise provided by contract, these drawings and specifications are property of the University of North Texas, and are issued in strict confidence and shall not be made available, reproduced, copied, or used for any other intended purpose without written permission.

Issue:
Date: December 21, 2021
Drawn By: PL
Checked By: PL
Sheet Name
TYPICAL DTL
Sheet Number
DTL

Figure 36 Handrail Detail

Signage Schedule UNT Chemistry Building						Refer sheet 5.10 for sign types and locations. All signs to be mounted on corridor side unless otherwise noted.		
Rm. No.	Door No.	Name	Sign Type	Sign Location	Number	Wording 1	Wording 2	Remarks
101	N/A	RECEPTION	2	A	101	Student Service	-	SIGN ON EXISTING STOREFRONT BY EXISTING DOOR
101A	101A	WORK ROOM	1	A	101A	-	-	
101B	101B	OFFICE	1	A	101B	-	-	
			8	A	-	OCCUPANT NAME	-	
101C	101C	OFFICE	1	A	101B	-	-	
			8	A	-	OCCUPANT NAME	-	
101D	101D	OFFICE	1	A	101B	-	-	
			8	A	-	OCCUPANT NAME	-	
101E	101E	OFFICE	2	A	101E	Ruthanne Thomas	-	
101D	101F	OFFICE	-	-	-	-	-	
103	103	MAIL ROOM	1	A	103	-	-	
104	104	STUDY	2	D	104	Lounge	-	
104A	104A	COFFEE	1	A	104A	-	-	
105	105	CONFERENCE	2	D	105	Conference	-	

Figure 37 Sample Signage Schedule

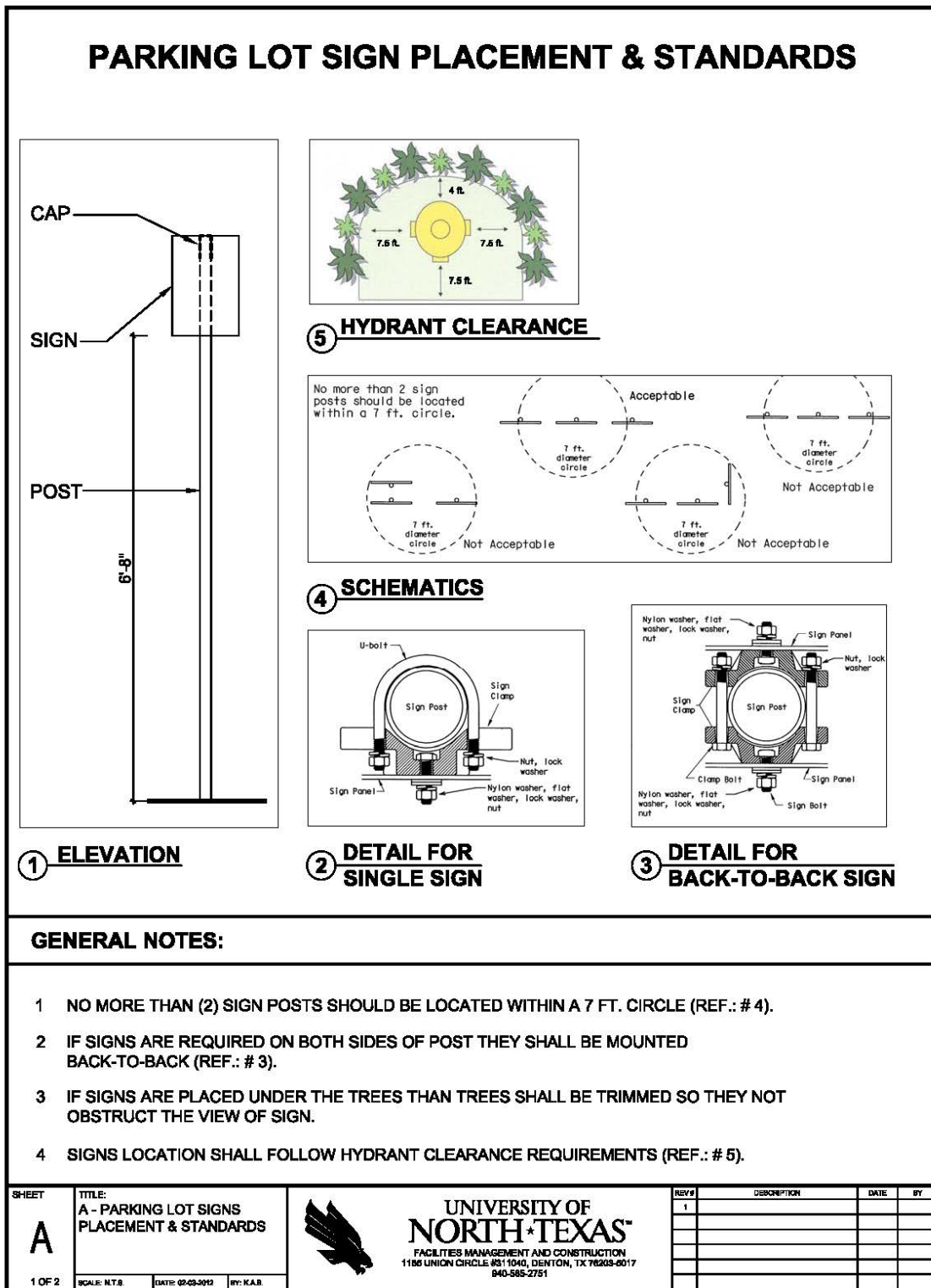

Figure 38 Parking Lot Sign Placement and Standards

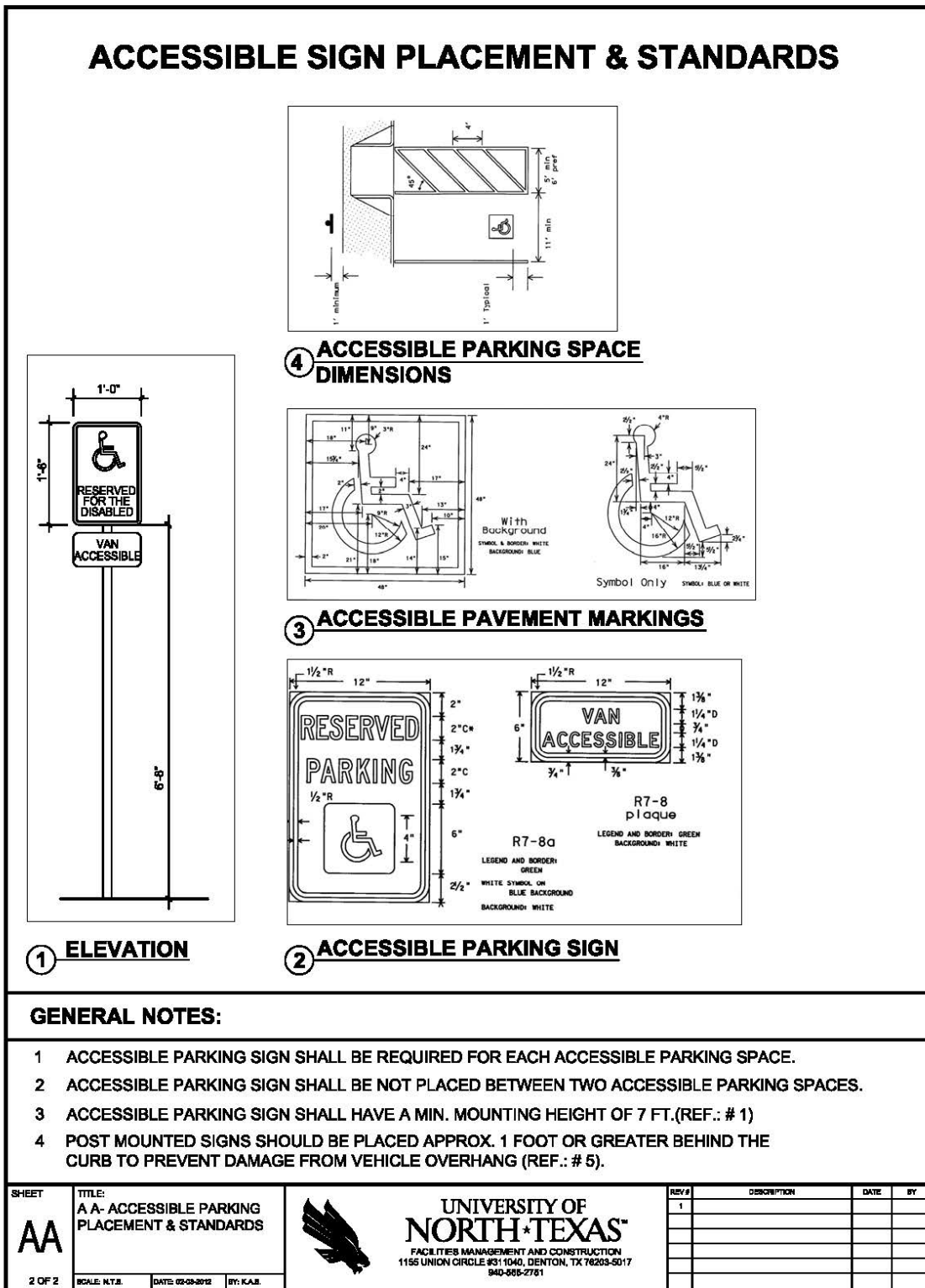

Figure 39 Accessible Sign Placement and Standards

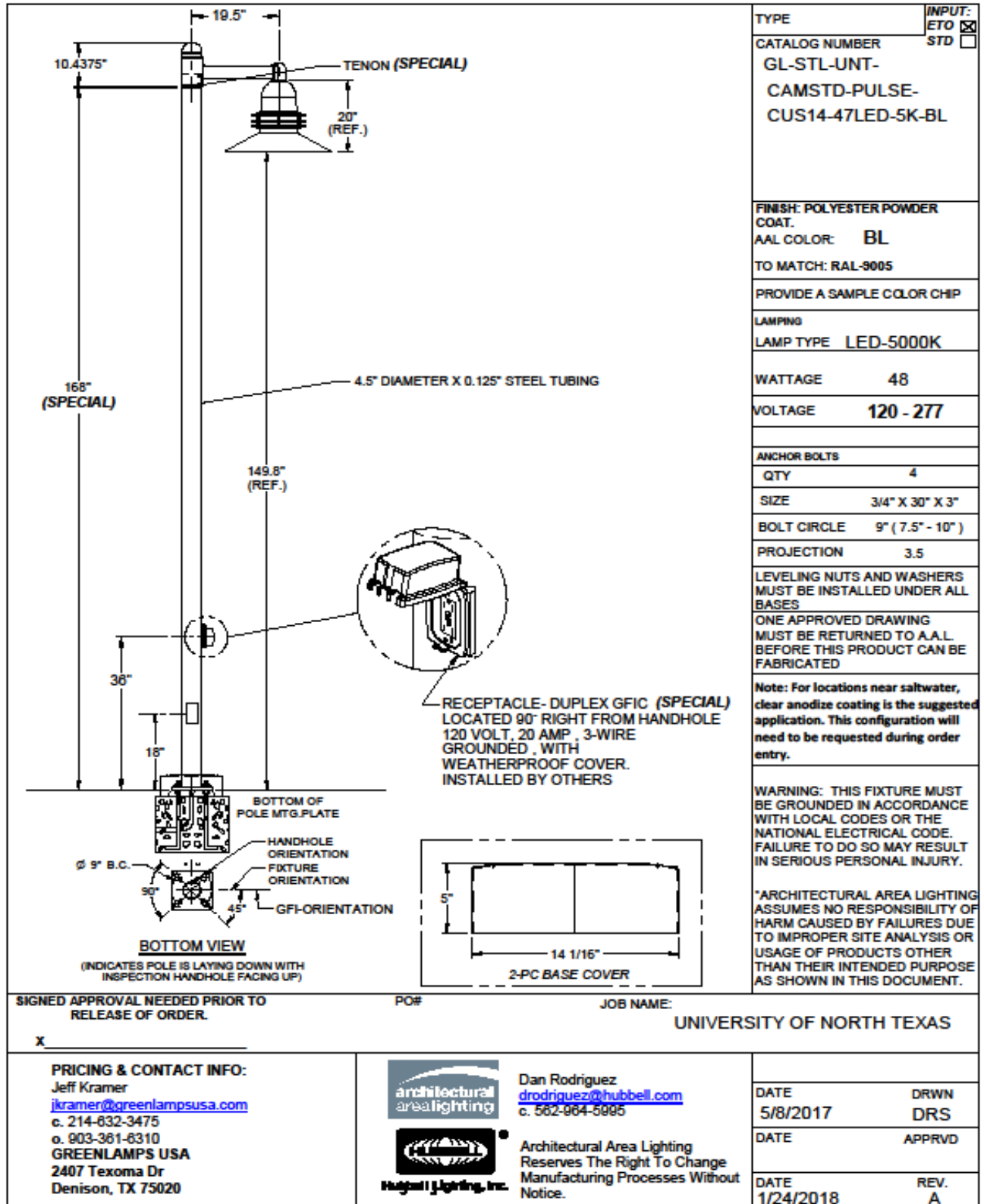
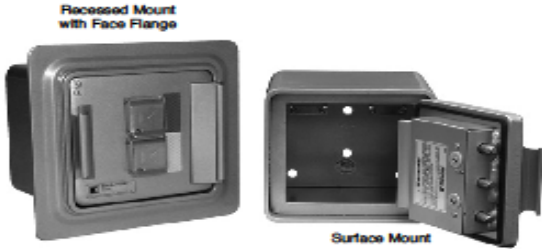

Figure 40 Standard Light Pole Specification



**KnoxVault™ 4400  
DUAL LOCK MODEL**

**High Security Industrial/Government Key Vault**



KnoxVault 4400 key boxes are used in larger businesses, industrial properties, public buildings and universities. The heavy-duty, high security KnoxVault 4400 protects and stores building keys, access cards and floor plans for emergency entry. The vault also provides secure storage for other internal and external applications.

**Features and Benefits**

- Holds up to 50 keys in the large interior compartment
- Ensures high security with UL® Listed Medeco lock(s)
- Includes Knox-Coat® that is four times better than standard powder coat
- Resists moist conditions with a weather resistant door gasket
- Colors: Black, Dark Bronze or Aluminum
- Weight: Surface mount - 28 lbs.  
Recessed mount - 29 lbs.

**Options**

- Tamper Alert (UL Listed)
- Recess Mounting Kit (RMK) for recessed models only
- Custom vault depth available
- Inside switch for use on electrical doors, gates and other electrical equipment

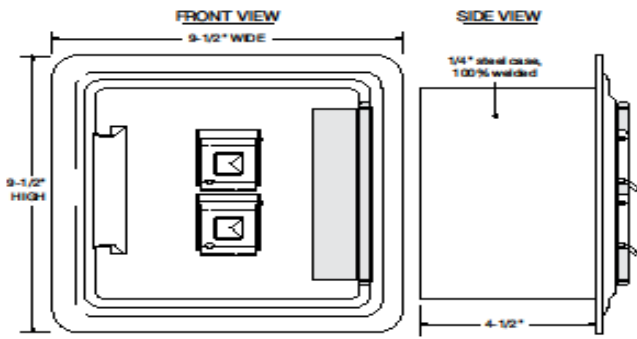
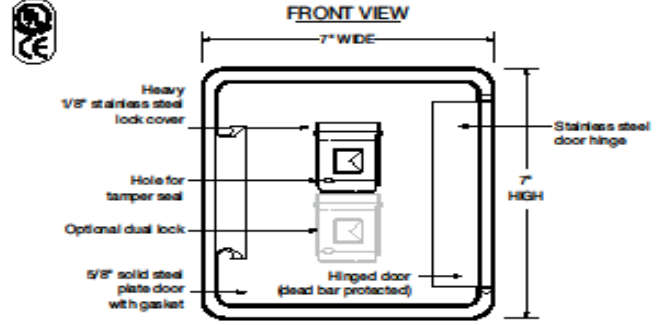

**Ordering Specifications**

To insure procurement and delivery of the KnoxVault 4400, it is suggested that the following specification paragraph be used: KnoxVault surface/recessed mount, with/without UL Listed tamper switches. 1/4" plate steel housing, 5/8" thick steel door with interior gasket seal. Vault and lock UL Listed. Lock has 1/8" dust cover with tamper seal mounting capability. Vault has anti-theft re-locking mechanism with drill resistant hard-plate lock protector.

Exterior Dimensions:

Surface mount:	7"H x 7"W x 5"D
Recessed mount flange:	9 1/2"H x 9 1/2"W

Lock: UL Listed. Double-action rotating tumblers and hardened steel pins accessed by a biased cut key.

Finish: Knox-Coat® proprietary finishing process  
Finish Color - Black, Dark Bronze or Aluminum

P/N: 4400 Series KnoxVault (mfr's cat. ID)

Mfr's Name: **KNOX COMPANY**

KNOX COMPANY • 1601 W. Deer Valley Road, Phoenix, AZ 85027 • (800) 552-5999 • (523) 687-2300 • Fax (523) 687-2290 • www.knoxbox.com • info@knoxbox.com

Figure 41 Exterior Emergency Key Cabinet Specification



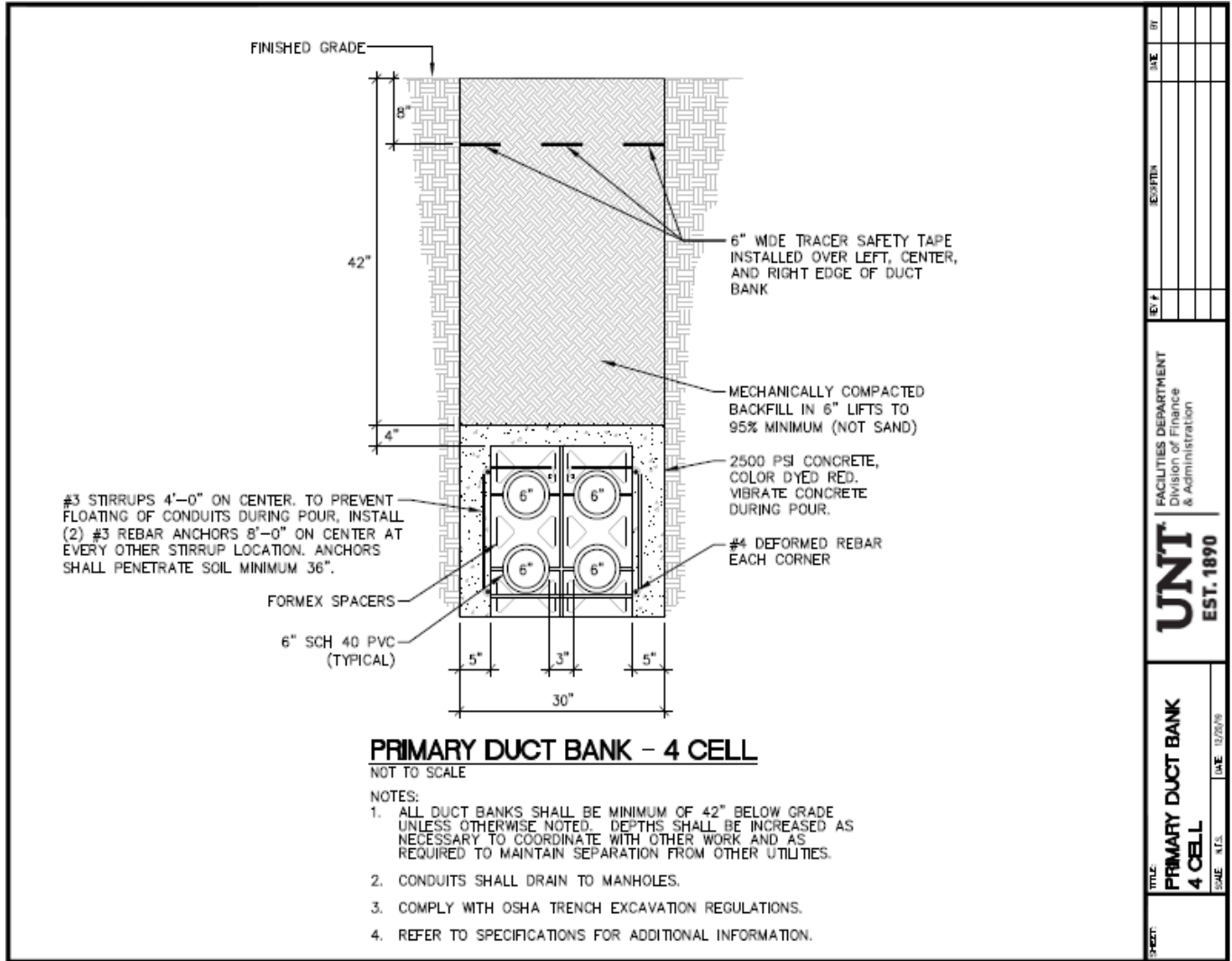

Figure 42 Primary Power Duct bank 4-Cell

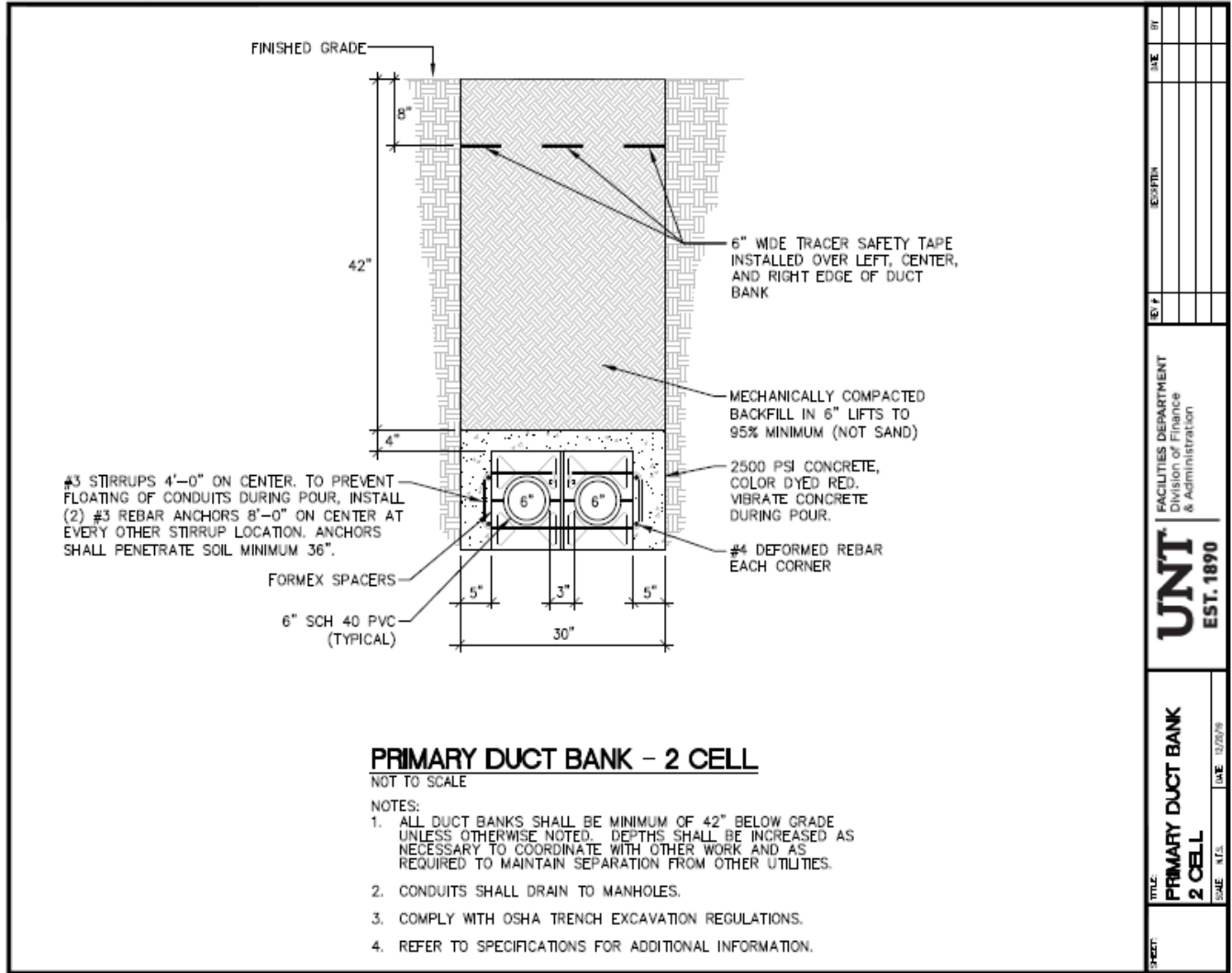

Figure 43 Primary Power Duct Bank 2-Cell



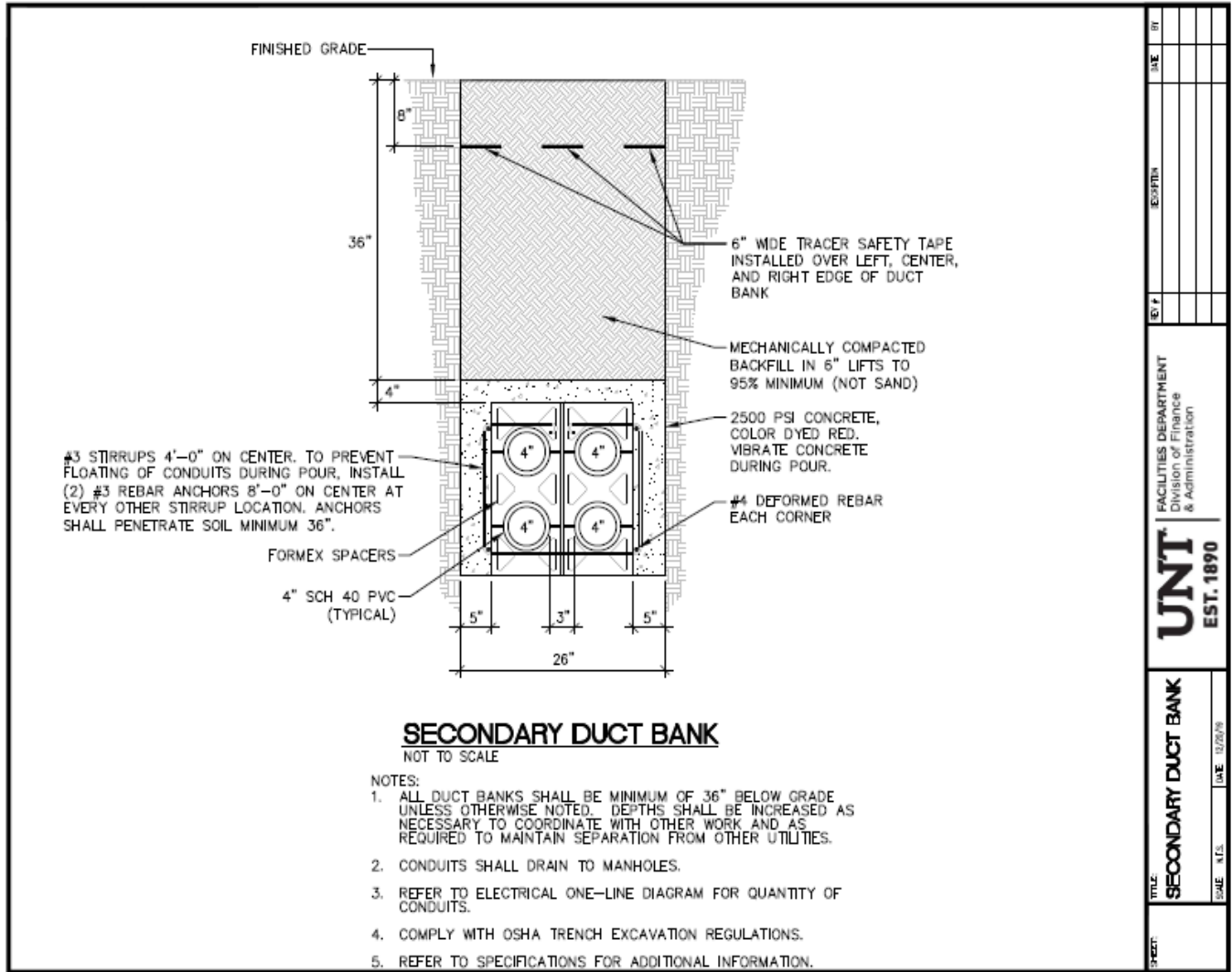

Figure 45 Secondary Power Duct Bank

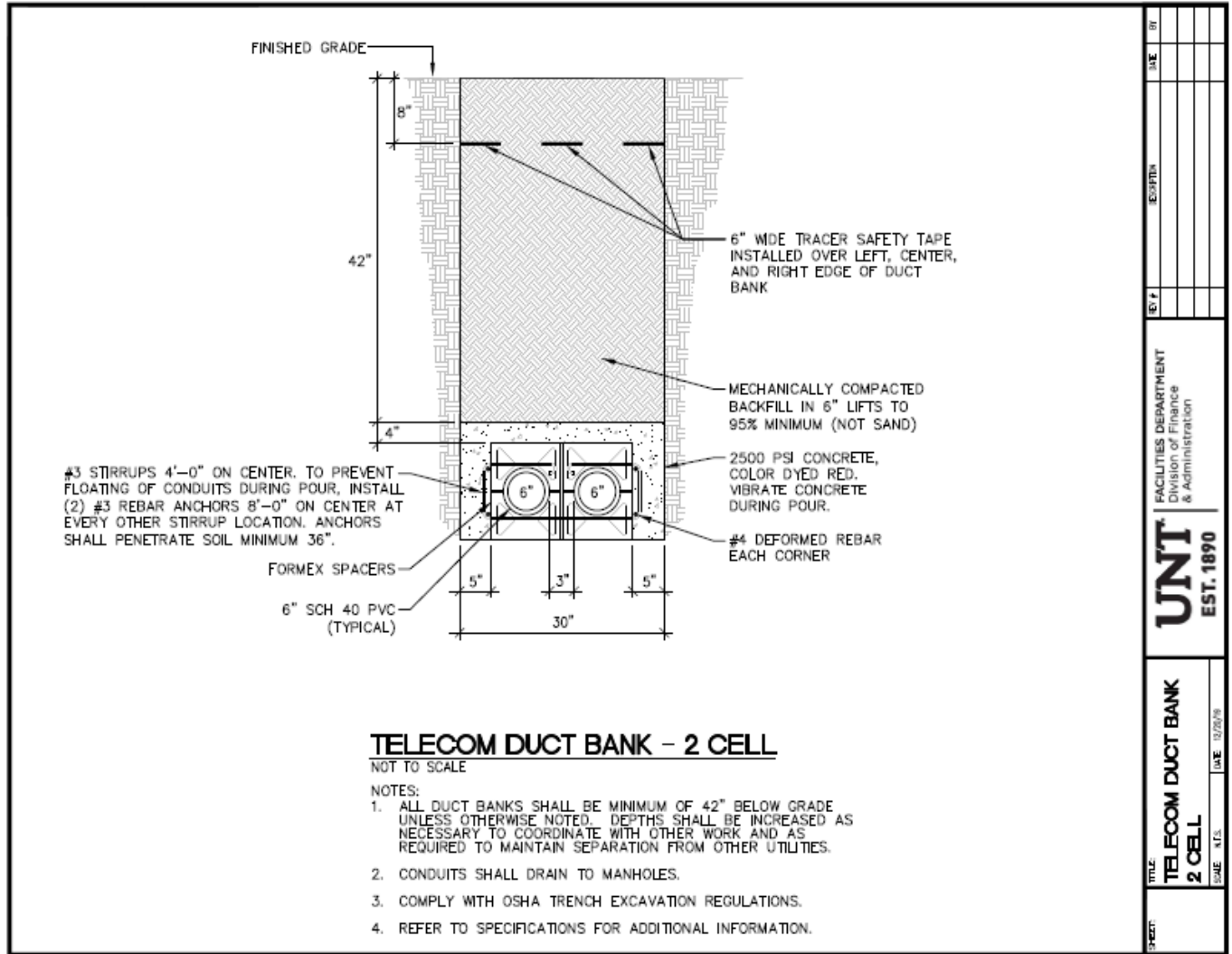

Figure 46 Telecommunications Duct bank

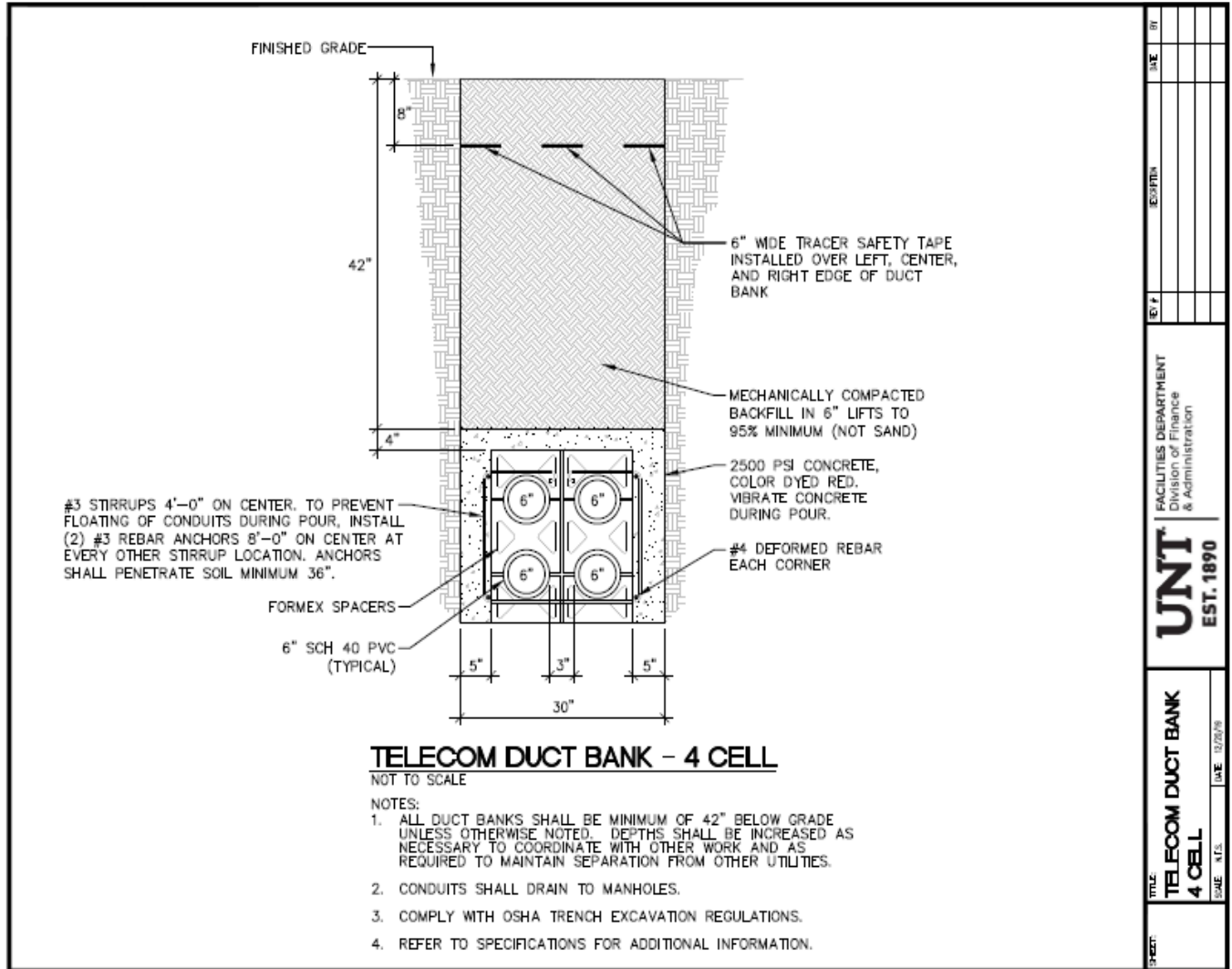

Figure 47 Telecommunications Duct Bank 4 Cell

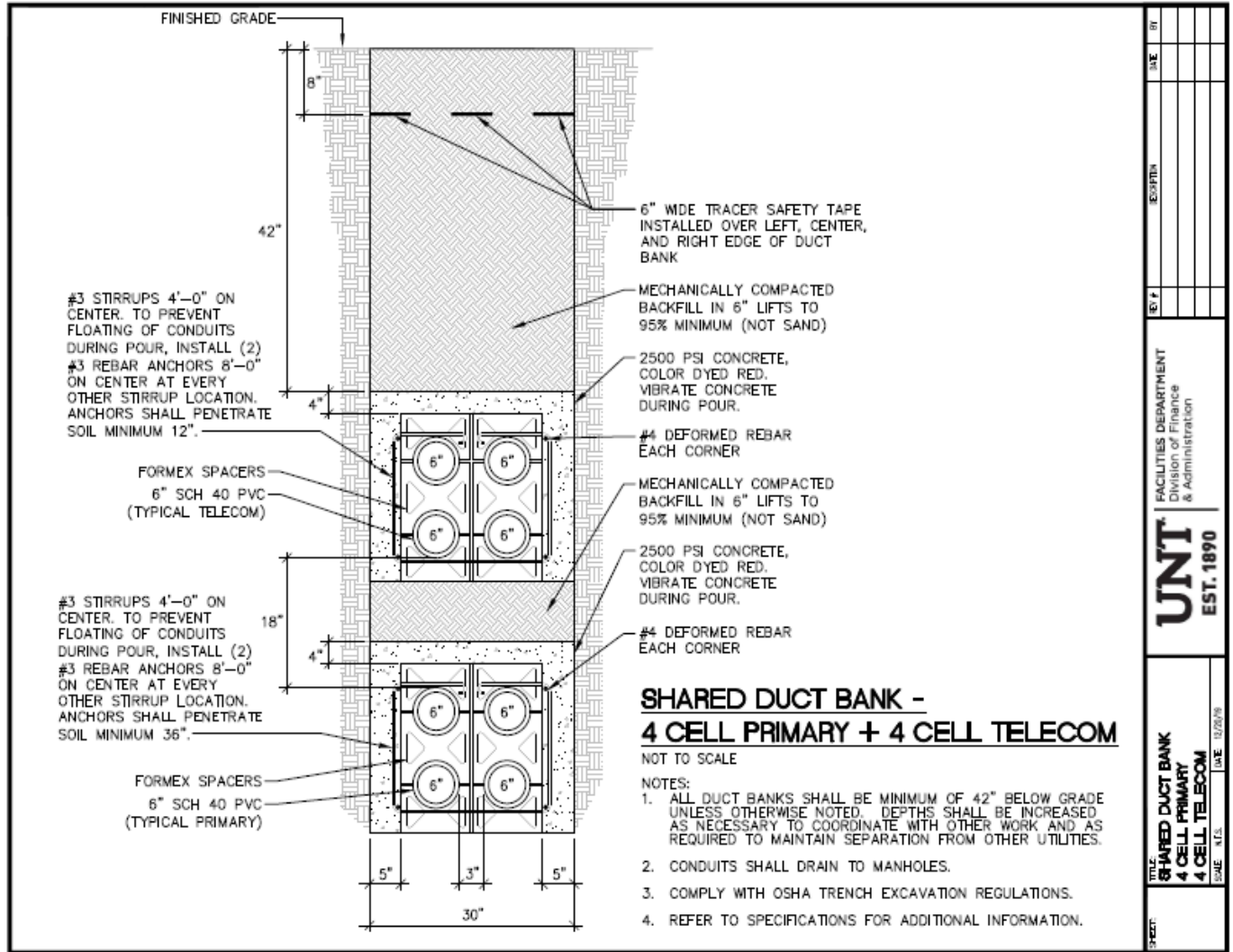

Figure 48 Shared Duct bank 4 Cell Primary & 4 Cell Telecom



Limited Time Offer: FREE GROUND SHIPPING on all online orders!

# WALL CABINET: SURFACE MOUNT

PART # 50-00392-10

\$192.00

Qty:

1

ADD TO CART

You are not currently logged in. Please log in ([../Profile/login.aspx](#)) to obtain the best pricing and availability.  
([https://shop.cardiacscience.com/PublicStore/images/temp/32-360-Product\\_Image.jpeg](https://shop.cardiacscience.com/PublicStore/images/temp/32-360-Product_Image.jpeg))



([https://shop.cardiacscience.com/PublicStore/images/temp/v-504911016000000000/32-360-Product\\_Image.jpeg](https://shop.cardiacscience.com/PublicStore/images/temp/v-504911016000000000/32-360-Product_Image.jpeg))

[VIEW LARGER IMAGE](#)

This well-constructed AED wall cabinet is designed to store your AED in an easily accessible location. The AED sits inside the cabinet with a transparent door for better visibility. AED can be stored inside the cabinet with or without a carry bag.

## SPECIFICATIONS

Sizing: Internal (H/W/D): 17.5 in (44.4 cm) X 17.5 in (44.4 cm) X 7 in (17.8 cm), External (H/W/D): 14.25 in (36.20 cm) X 14.25 in (36.20 cm) X 7 in (17.78 cm). Protrusion from the wall: 7 in (17.78 cm).

Material: Stainless Steel. Included: All hardware and two keys. Spare Key: p/n 50-00599-01

*Figure 49 AED Wall Cabinet*



<b>UCB – Universe Bollard</b>							TYPE							
<ul style="list-style-type: none"> <li>LED technology</li> <li>Modular system offers five luminous choices and two hood options for customization to complement site design</li> <li>Full cutoff option available</li> </ul>				<ul style="list-style-type: none"> <li>Glass refractor lens, IES Type 5 distribution</li> <li>IP65 rated</li> <li>Powder coat finish in 13 standard colors with a polymer primer sealer</li> </ul>										
1. LUMINAIRE	2. LUMINOUS	3. HOOD	4. LAMP/BALLAST	5. COLOR	6. OPTIONS	7. OPTIONS (internal)								
<b>1. LUMINAIRE</b> UCB Universe bollard				<b>5. COLOR</b> WH Arctic White      VBU Verde Blue BL Black                CRT Corlen BLT Matte Black        M4L Matte Aluminum DB Dark Bronze        MG Medium Grey DGN Dark Green        AGN Antique Green TT Titanium              LG Light Grey WDB Weathered Bronze RAL Premium Color MDB Bronze Metallic    CUSTOM** Contact Factory		<b>SPECIFICATIONS</b> <b>HOUSING</b> The fixture housing, shade, and base are cast aluminum, A356 alloy, free of any porosity, foreign materials, or cosmetic fillers. The shaft shall be 6" wide and 34 1/4" tall, extended 6061-T6 aluminum. The ballast or driver is mounted internally and accessed by loosening three set screws and lifting the fixture head off of the shaft. Relamping is done by removing three stainless steel acorn nuts underneath the shade and lifting it off the base. The lens is press molded, tempered borosilicate glass, sealed to the fixture body with a die cut silicone gasket. All internal and external hardware is stainless steel. <b>ELECTRICAL</b> The ballast is integral to the fixture, mounted on a prewired module with a quick disconnect plug. The ballast module has two keyhole slots and is removable by loosening two screws. Sockets are pulse rated porcelain. HID ballasts are high power factor, rated for 30°C starting. Ballasts are multitap, wired at the factory for 277 volts, unless specified. Compact fluorescent transformers are electronic, 120 through 277 volt for 25, 32 or 42 watt 4 pin lamps. Standard LED color temperatures are 3000K, 4000K and 5000K. Other color temperatures available. Please contact factory. LED constant current driver operates at 700mA. <b>FINISH</b> Fixture finish consists of a five stage pretreatment regimen with a polymer primer sealer, oven dry off, and top coated with a thermoset super TGIC polyester powder coat finish. The finish shall meet the AAMA 605.2 performance specification which includes passing a 3000 hour salt spray test for corrosion resistance.								
<b>2. LUMINOUS ELEMENT – Optional</b> BLANK (No luminous element) SR (Solid Rings - 7.5" / 90mm O/A x 2.75" / 70mm H) LUW (Luminous Rings - 7.625" / 197mm O/A x 2.75" / 70mm H) WND (3 Windows - 5.25" / 130mm O/A x 2.75" / 70mm H) VSL (Vertical Slots - 5.25" / 130mm O/A x 2.75" / 70mm H)				<b>6. OPTIONS - HOOD</b> The natural copper and stainless steel hoods are unfinished to develop a patina over time. All hoods have the under side finished in high reflectance white. COP (Copper)      STS (Stainless steel)		<b>7. OPTIONS - INTERNAL</b> SLC (Internal sleeve to block light when luminous element chosen) 347 (For HO, except 50MH & 50HPS. Not available with LED) HSS (House side shield. Factory installed) BBU (Battery backup powers a compact fluorescent lamp for up to 90 minutes during a power failure. Operating temp 0°C to 66°C. Not available with LED)								
<b>3. HOOD</b> STR (Straight Hood - 16" / 405mm O/A x 3.12" / 80mm H) FLR (Flared Hood - 15" / 380mm O/A x 4.75" / 120mm H)				<b>4. LAMP/BALLAST</b> LED (Warm white (3000K), Neutral white (4000K), Bright white (5000K). 32 watts. 120 thru 277 volt) 12LED-WW (Warm white) 12LED-NW (Neutral white) 12LED-BW (Bright white) COMPACT FLUORESCENT (120 thru 277 volt ballast. Use 4-pin, 25, 32 or 42 watt lamp. -18°C min start temp) CF METAL HALIDE Medium base, E0-17 lamp 50MH                      70MH G12 base, T-6 ceramic lamp 70MH T6 ELECTRONIC METAL HALIDE Medium base, E0-17 lamp 50MH EB                70MH EB G12 base, T-6 ceramic lamp 70MH T6 EB              39MH T6 EB HIGH PRESSURE SODIUM Medium base, E0-17 lamp 50HPS                    70HPS All ballasts and LED drivers are prewired for 277 volts unless specified. Lamps not included (except LED and H options).		See next page								
<table border="1" style="width: 100%; border-collapse: collapse;"> <tr> <td style="padding: 5px;">TYPE</td> <td style="border-bottom: 1px solid black; width: 100px;"></td> </tr> <tr> <td style="padding: 5px;">JOB</td> <td style="border-bottom: 1px solid black;"></td> </tr> <tr> <td style="padding: 5px;">NOTES</td> <td style="border-bottom: 1px solid black;"></td> </tr> <tr> <td style="padding: 5px;"></td> <td style="border-bottom: 1px solid black;"></td> </tr> </table>							TYPE		JOB		NOTES			
TYPE														
JOB														
NOTES														



ARCHITECTURAL AREA LIGHTING  
 16665 East Gale Ave. | City of Industry | CA 91746  
 P 626.968.6666 | F 626.369.2696 | www.aal.net  
 Copyright © 2012 | Rev 10.15

| 1 |

Figure 50 Standard Light Bollard Specification 1

**UCB – Universe Bollard**

TYPE

**CERTIFICATION**

The fixture is listed with ETL for outdoor, wet location use, UL1570 & 1572 and Canadian CSA Std. C22.2 NO.9. IP Rating: 55

**WARRANTY / TERMS AND CONDITIONS OF SALE**

Download: <http://www.hubbelling.com/resources/warranty/>

**DIMENSIONS**

LUMINOUS ELEMENT

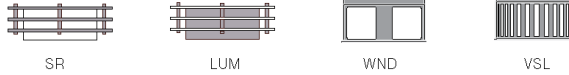

HOOD

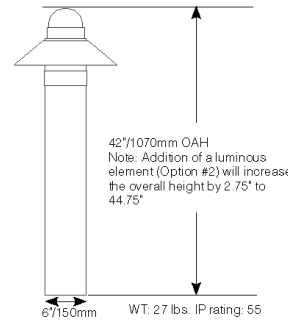

**UCB** WATTAGE: 85 LUMEN OUTPUT: 811 EFFICACY: 65.9

**B1 U0 G0**

FORWARD LIGHT		LUMEN
FL	30° 0.4%	22
FM	60° 3.0%	170
FH	80° 3.7%	205
FVH	90° 0.2%	9
BACK LIGHT		LUMEN
BL	30° 0.4%	22
BM	60° 3.0%	170
BH	80° 3.7%	205
BVH	90° 0.2%	9
UPLIGHT		LUMEN
UL	100° 0%	0
UH	180° 0%	0

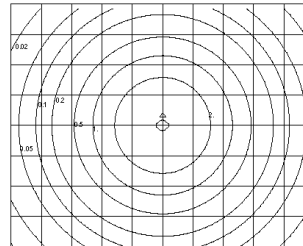

UPLIGHT 0%  
DOWNLIGHT 100%

**UCB 12LED BW** WATTAGE: 33 LUMEN OUTPUT: 703 EFFICACY: 21.3

**B1 U0 G1**

FORWARD LIGHT		LUMEN
FL	30° 7.3%	51
FM	60° 22.2%	156
FH	80° 20.8%	146
FVH	90° 2.4%	17
BACK LIGHT		LUMEN
BL	30° 6.8%	48
BM	60° 20.6%	145
BH	80° 18.2%	128
BVH	90° 1.8%	13
UPLIGHT		LUMEN
UL	100° 0%	0
UH	180° 0%	0

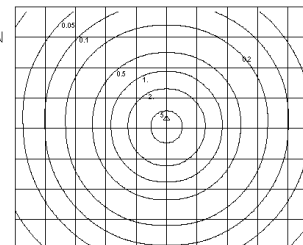

UPLIGHT 0%  
DOWNLIGHT 100%

AAL reserves the right to change product specifications without notice.

IES files can be found at [www.aal.net](http://www.aal.net)



ARCHITECTURAL AREA LIGHTING  
16555 East Gale Ave. | City of Industry | CA 91745  
P 626.968.5666 | F 626.369.2695 | [www.aal.net](http://www.aal.net)  
Copyright © 2012 | Rev 10.15

Figure 51 Standard Light Bollard Specification 2

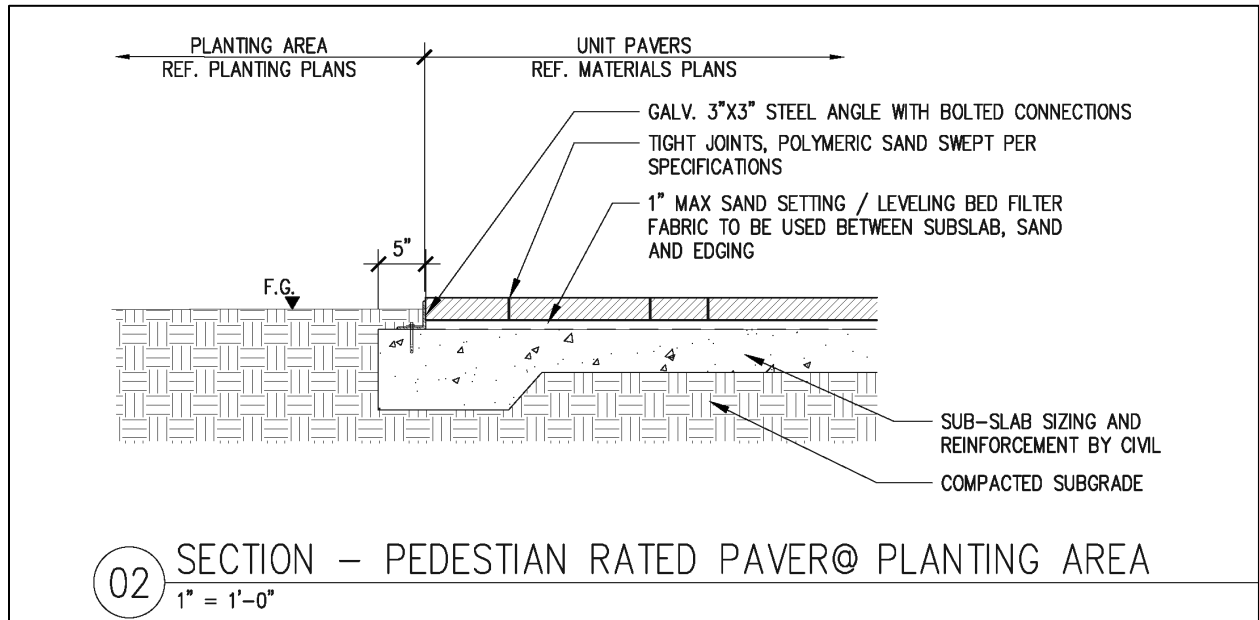

Figure 52 Paver Design

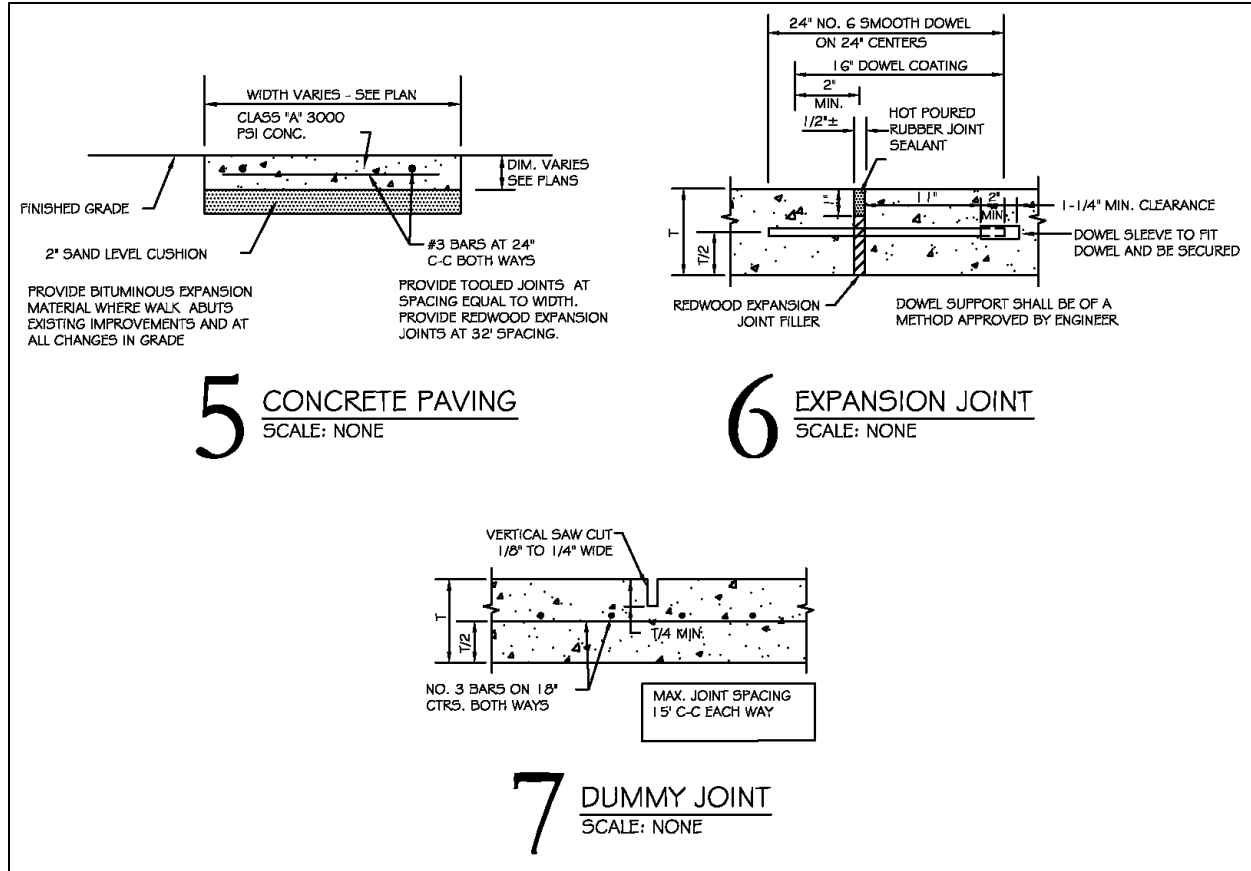

Figure 53 Control and Expansion Joints

[Intentionally blank]

## APPENDIX H: SPECIFICATIONS FOR CONSTRUCTION PROJECT ELECTRONIC DELIVERABLES

### UNT Construction Project Electronic Deliverables

UNT Facilities Planning, Design & Construction maintains standards and specifications for the creation and delivery of electronic record data for construction project files.

Contact the Associate Director of Facilities Planning, Design & Construction for the most current edition of this document.

## APPENDIX I: TRANSFORMER SPECIFICATION

### UNT Medium Voltage Transformer Standards

Latest revision 06/24/2014

#### Liquid Filled Pad Mounted Transformers

Three phase, pad mounted, liquid-filled, distribution type transformer. Standard sizes range from 75 – 5,000 KVA with primary rating from 2,400 to 46,000 V.

#### 1.0 REFERENCES

- A. ANSI/IEEE C37.47 - Specifications for Distribution Fuse Disconnection Switches, Fuse Supports, and Current-Limiting Fuses
- B. ANSI/IEEE C57.12.00 - General Requirements for Distribution and Power Transformers
- C. ANSI/IEEE C57.12.26 – Requirements for Distribution Transformers for use with Separable Insulated High-Voltage Connectors
- D. ANSI/IEEE C57.12.28 – Switchgear and Transformers, Pad-Mounted Equipment – Enclosure Integrity
- E. ANSI/IEEE C57.12.34 – Requirements for Pad-Mounted, Compartmental-Type, Self-Cooled, Three-Phase Distribution Transformers, 2,500 KVA and Smaller: High Voltage, 34,500 GrdY/19,920 Volts and Below; Low Voltage, 480 Volts and Below
- F. ANSI/IEEE C57.12.70 - Terminal Markings and Connections for Distribution and Power Transformers
- G. ANSI/IEEE C57.12.90 – Standard Test Code for Liquid-Immersed Distribution Power, and Regulating Transformers and Guide for Short-Circuit Testing of Distribution and Power Transformers
- H. ANSI/IEEE C57.12.91- Terminology for Power and Distribution Transformers
- I. ANSI/IEEE 386 – Separable Insulated Connector Systems for Power Distribution Systems above 600 V
- J. ASTM D877 – Test Method for Dielectric Breakdown Voltage of Insulating Liquids Using Disk Electrodes
- K. NEC 450-23, Less Flammable Insulating Oil
- L. NEMA TR-1 – Maximum Sound Levels
- M. DOE: 10 CFR Part 431 - Energy Conservation Program for Commercial Equipment: Distribution Transformers Energy Conservation Standards; Final Rule; October 12, 2007
- N. Factory Mutual Research Corporation – Approval Standard Class 3990

#### 2.0 PRODUCT

#### 2.1 MANUFACTURERS

- A. Acceptable Manufacturers:
  1. Cooper Power Systems
  2. General Electric Company
  3. Square D Company

## B. Quality Control

1. Company specializing in distribution transformers with five years documented experience. When requested, an acceptable list of installations with similar equipment shall be provided demonstrating compliance with this requirement.

## 2.2 PAD MOUNTED DISTRIBUTION TYPE TRANSFORMERS (PRIMARY 13.2 KV)

- A. Transformers shall be factory-assembled, three phase, delta-wye configuration, pad mounted, compartmental type, dead front, air-cooled (KNAN) distribution type transformers; ratings as below. All transformers shall be new.
- B. Transformers shall be Factory Mutual Approved Code Listed and Labeled by Factory Mutual Research Corporation as meeting the requirements of FMRC Approval Standard Class 3990. Transformers shall be designed and manufactured in accordance with current standards of ANSI and NEMA.

## C. Ratings:

1. \_\_\_\_\_ KVA
2. \_\_\_\_\_ Phase
3. Frequency 60 Hz
4. Primary Voltage 13,200 V Delta, 95 KV BIL; KV Class 15 KV
5. Secondary Voltage \_\_\_\_\_ Wye, 30 KV BIL; KV Class 1.2 KV
6. Taps: Full capacity, two 2½% above normal and two 2½% below normal taps.

## D. Coil and Core

1. Transformer shall have copper windings.
2. Isolate core and coil from enclosure using vibration-absorbing mounts.
3. The transformer shall carry its continuous rating with an average winding or temperature rise by resistance that shall not exceed 65 degrees C. rise, based on an average ambient temperature of 30 degrees C. over 24 hours, with a maximum of 40 degrees C. The insulation system shall allow an additional 12 % kVA output at 65-degree C. average winding temperature rise by resistance, on a continuous basis, without any decrease in normal transformer life.
4. Insulation fluid shall be FR3 less flammable insulation fluid per NEC 450-23.
5. Provide a 5 position tap changer operator, located in one of the compartments, for de-energized tap-changing operation with pad lockable handle.
6. Transformers shall conform to 2010 standard efficiency levels for liquid immersed distribution transformers, as specified in Table I.1 of the Department of Energy ruling, 10 CFR Part 431.
7. Sound Levels: Guaranteed sound levels shall not exceed NEMA TR-1. Maximum sound levels.

## E. Terminations and Fusing

1. The terminations and equipment shall be arranged for radial feed.
2. The high voltage terminations and equipment shall be dead front and conform to ANSI C57.12.26 requirements. Provide universal type bushing wells for use with elbow terminators and parking stands for mounting accessory equipment. Bushing wells shall be externally clamped. Inserts (feed-thru type) and load break elbows shall be included.

3. Provide a two position, oil-immersed, gang operated, rotary, loadbreak switch with internal fuse link. The switch mechanism shall be spring loaded and the operation shall be independent of operator speed. The switch shall have the following ratings: 200 amps continuous current. Momentary current 15,000 amps symmetrical (10 cycles), 25,000 amps asymmetrical (first peak). Load interrupting 200 amps at 70% power factor.
4. Provide Bay-O-Net type oil immersed fuses in series with oil immersed current limiting fuses to conform to the requirements of Factory Mutual. Provide three (3) spare Bay-O-Net fuses with the transformer.
5. Provide three (3) - 10 kV M.O.V.E deadfront metal oxide varistor elbow arresters for placement in the high voltage compartment connected to the feed-thru inserts.
6. Provide bushing wells, 15 KV, 95 KV BIL feed through inserts (3), lightning arrestors, 15 KV, 95 KV BIL load break inserts, and load breaker elbows.
7. The low voltage bushings shall be molded epoxy and provided with blade type spade terminals with NEMA standard hole spacing arranged for vertical take-off. The low voltage neutral shall be an insulated bushing grounded to the transformer tank by a removable grounding strap. Wye-wye connected transformers shall have the high and low voltage neutrals internally tied with a removable link for testing.

#### F. Enclosure

1. The transformer(s) shall be compartmental type, self-cooled, tamper resistant and weather protected for mounting on a pad. There shall be no exposed screws, bolts or other fastening devices that are externally removable.
2. The transformer shall be of the sealed tank construction of sufficient strength to withstand a pressure of 7 psi without permanent distortion. The cover shall be welded, and the fastenings tamper resistant. The transformer will remain effectively sealed for a top oil temperature range of -5° C. to 106° C. When required, corrugate cooling panels or radiators will be provided on the back and sides of the tanks. Construction shall consist of carbon steel plate reinforced with external side-wall braces. All seams and joints shall be continuously welded.
3. Lifting eyes and jacking pads will be provided.
4. The high and low voltage compartments shall be located side-by-side separated by a steel barrier. When facing the transformer, the low voltage compartment shall be on the right. Terminal compartments shall be full height, air filled with individual doors. The high voltage door fastenings shall not be accessible until the low voltage door has been opened. The low voltage door shall have a 3-point latching mechanism with a cabinet handle having provisions for a single padlock. Penta-head cabinet door bolts shall be furnished for the low voltage door. The doors shall be equipped with lift-off type stainless steel hinges and door stops to hold the doors open when working in the compartments. The front sill of the compartment shall be removable to allow the transformer to be rolled or skidded into position over conduit stubs. ANSI tank grounding provisions shall be furnished in each compartment.
5. The enclosure shall have suitable outdoor paint finish. Topcoat shall be Bell Green (Munsell 7GY 3.29/1.5). Paint shall meet factory standard ANSI C57.12.28 for outdoor service and shall be applied in accordance with the manufacturers written instructions. Provide written certification by a registered professional Engineer that the paint and application comply with the ANSI Standard Specified.



6. Each radiator assembly shall be individually welded and receive a quality control pressurized check for leaks. The entire tank assembly shall receive a similar leak test before tanking. A final six-hour leak test shall be performed after the transformer is tanked, welded and completed to ensure that there are not leaks before shipment. Include the test results in the certified test report.

#### G. Accessories

1. Liquid level gauge,
2. Dial type thermometer
3. Pressure vacuum gauge
4. Drain/sampling and filter valve,
5. Ground connectors
6. Schrader type, upper fill valve.
7. Pressure relief valve.
8. Provisions for lifting and provisions for jacking.
9. Base designed for skidding or rolling in two directions.
10. Manufacturer's standard, automatic, pressure relief device, that automatically reseals after operation.
11. Instruction nameplate.
12. Welded-on main tank cover and bolted handhole in cover or bolted cover.
13. Non-corroding metal identification name plate with black lettering. Information to be provided during shop drawing review.
14. Insulated caps and insulated parking bushings for each bushing well.
15. Cabinet accessories pocket on compartment door for spare fuses.

#### H. Labels

1. Notifications: Danger: High Voltage decal
2. Notifications: DOE Efficiency Compliant decal
3. Notifications: Non-PCB decal
4. Certification: Factory Mutual (FM) approved, outdoor installation

#### I. Testing

1. The following factory tests shall be made on each transformer. Tests shall be in accordance with the latest revision of ANSI Test Code C57.12.90 and/or NEMA TR1:
  - a. Resistance measurements of all windings on the rated voltage connection and at the tap extremes of each unit.
  - b. Ratio tests on the rated voltage connection and on all tap connections.
  - c. Polarity and phase-rotation tests on the rated voltage connections.
  - d. No-load loss at rated voltage on the rated voltage connection.
  - e. Exciting current and rated voltage on the rated voltage connection.
  - f. Percent Impedance, core loss, winding loss, excitation current, at rated current on the rated voltage connection and on the tap extremes of each unit.
  - g. Temperature Test or tests shall be made on each unit. Tests shall not be required when there is available a record of a temperature test on an essentially duplicate unit.
  - h. Applied potential test.
  - i. Induced potential tests.
  - j. Leak test to check for leaks at welds and bushings.

- k. Results of the above tests shall be submitted in the form of certified test report for each transformer sealed by a registered professional engineer attesting that the tests were personally witnessed.
- l. Furnish a certified copy of the transformer loss test report sealed by a registered professional Electrical Engineer. The report shall certify the efficiency of each transformer measured in accordance with ANSI Standard C57.12.90-1973.

## APPENDIX J: UNT FACILITIES ATTIC STOCK PROCEDURES

### UNT Attic Stock Procedures

Latest revision 03/29/2011

For new buildings it is required that a secured storage area within the building be identified as part of the building program. A full complement of attic stock materials should be provided by the contractor at close-out.

For building renovations, due to a lack of available storage, attic stock items are to be identified early on in the design phase to determine critical needs. Generally, these will be items to support equipment rooms and will not include architectural materials unless specialty non- university standard finishes are specified. The attached check list should be filled out by Facilities identifying these items.

In no case will remnant construction materials (such as small pieces or opened packages) be retained as attic stock.

Contractor shall provide UNT Facilities with a written list including amounts as part of the close-out document package.

All attic stock items should be clearly labeled with the date, construction project and stock information.

Sample attic stock check list:

- Architectural materials (new buildings or specialty areas only)
  - Extra ceiling materials
  - Extra cans of paint
  - Sealants
  - Masonry materials
  - Flooring
  - Wall covering
  - Paint
- Fire Protection
  - Sprinkler heads
- HVAC
  - Spare filters
  - Spare drive belts & motors
  - Fusible links
- Electrical
  - Wiring devices
  - Fixture lenses & bulb covers
  - Lamps
- Plumbing
  - Filters
  - Trim

<b>"X" indicates to be included in contract</b>	<b>Specification Section</b>	<b>Material</b>	<b>Provided Attic Stock</b>
	087100	Door Hardware	Special Tools Maintenance Tools
	093000	Tiling	Tile and Trim Units - 3% of installed Grout - 3% of installed
	095113	Acoustical Panel Ceilings	Ceiling Tile, Grid, and Clips: 2% of installed
	095133	Acoustical Metal Pan Ceilings	Ceiling Tile, Grid, and Clips: 2% of installed
	096513	Resilient Base and Accessories	Wall Base: 10 ft. for every 500 ft. of Each Type, Color, Pattern and Size Used
	096519	Resilient Tile Flooring	Floor Tile: 1 box for every 50 boxes of Each Type, Color, and Pattern Used
	096813	Tile Carpeting	Carpet Tile: 5% of Each Type Used, Not Less Than 10 sq. yd.
	096816	Sheet Carpeting	Carpet Rolls: 5% of installed
	097713	Panel Fabric Wall and Ceiling Systems	5% of Gross Wall and Ceiling Area of Each Color Pattern and Type Used
	099113	Exterior Painting	Paint: 5% of Applied, Not Less than (1) Gallon
	099123	Interior Painting	Paint: 5% of Applied, Not Less than (1) Gallon
	099646	Intumescent Painting	Paint: 5% of Applied, Not Less than (1) Gallon
	102226	Operable Partitions	

			Panel Finish Material: Two sides of Two Panels
	122413	Roller Window Shades	Roller Shades: 5% of Installed, but No Fewer Than 2 Units, for Each Size, Color, and Shadeband
	211313	Wet-Pipe Sprinkler Systems	Spare Heads and Wrenches in Cabinets
	224700	Drinking Fountains & Water Coolers	Filter Cartridges: 10% of Installed, not <1 Each Type
	232123	Hydronic Pumps	Seals: (1) for Each Pump
	233300	Air Duct Accessories	Fusible Links: 10% of Installed
	233416	Centrifugal HVAC Fans	Belts: 1 Set for Each Belt-Driven Unit
	233423	HVAC Power Ventilators	Belts: 1 Set for Each Belt-Driven Unit Motor Puller for Fans >5 HP
	233600	Air Terminal Units	Pan-Powered-Unit Filters: (1) Spare Filter for Each Filter Installed
	234100	Particulate Air Filtration	Filters: (2) Sets for Each Filter Bank
	237313	Modular Indoor Central-Station Air-Handling Units	Filters: (2) Sets for Each AHU Belts: (1) Set for Each AHU Fan
	238126	Split-System Air-Conditioners	Filters: (1) Set / Unit Fan Belts: (1) Set / Unit
	238219	Fan Coil Units	Filters: (2) Spare for Each Installed Belts: (2) Spare for Each Installed
	261300	Medium-Voltage Switchgear	Touch-Up Paint Can: Munsell Green 9999-058
	271500	Communications Horizontal Cabling	Patch-Panel Units, Connecting Blocks Device Plates Multiuser Telecom Outlets: (1) Each Type

	283111	Digital, Addressable Fire-Alarm System	Lamps, Smoke Detectors, Fire Detectors, Detector Bases, Keys and Tools, Notification Appliances, Fuses
	321413.19	Permeable Interlocking Concrete Pavement	(1) Palette of Each Color and Type Used
	328400	Planting Irrigation	(5) Parts Each of Irrigation Components

## APPENDIX K: GUIDELINES FOR LAND SURVEY WORK

### UNT Guidelines for Land Survey Work

UNT Facilities Planning, Design & Construction maintains specifications for the execution of land survey work on behalf of the University, including specifications for deliverables of land survey work.

Contact the Associate Director of Facilities Planning, Design & Construction for the most current edition of this document.